

Levelling Feet

pad plastic, bolt steel

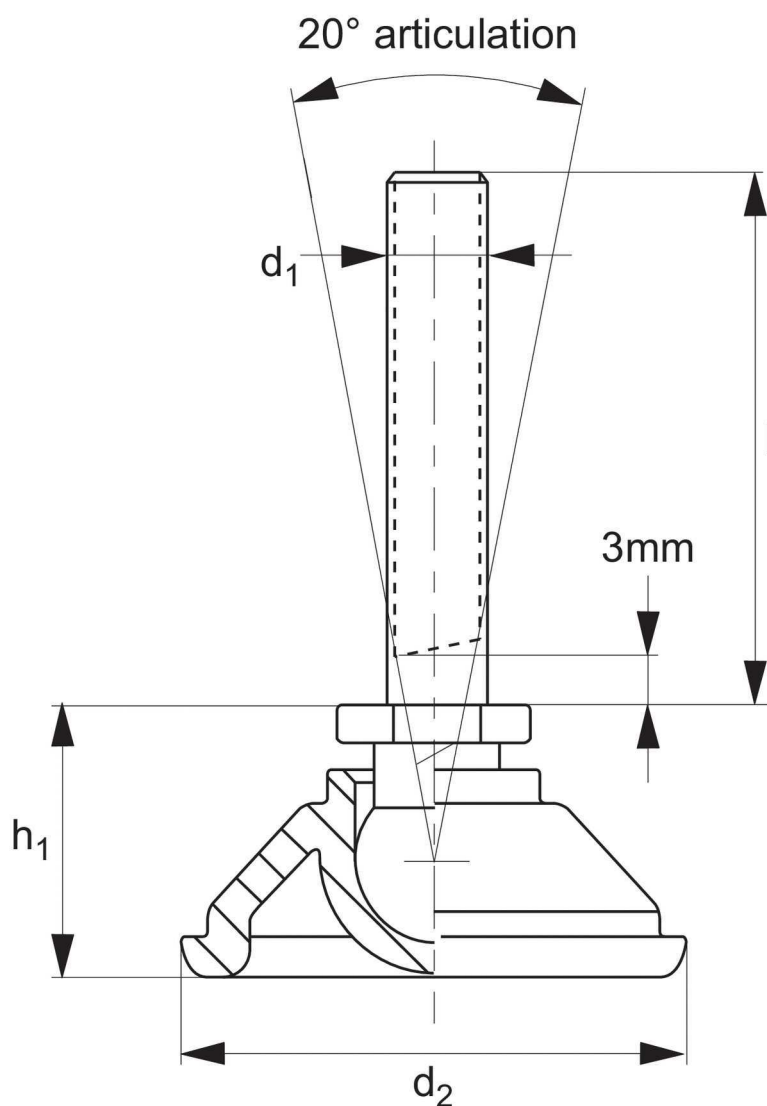

34721



Material

Pad: polyamide reinforced nylon.
Bolt: mild steel, plated.



Order No.	d_1	l	d_2	h_1	Max. static load kN
34721.W0060	M 6	20	40	21	3,0
34721.W0061	M 6	20	50	23	3,0
34721.W0062	M 6	40	40	21	3,0
34721.W0063	M 6	40	50	23	3,0
34721.W0080	M 8	25	40	21	4,5
34721.W0081	M 8	25	50	23	4,5
34721.W0082	M 8	40	40	21	4,5
34721.W0083	M 8	40	50	23	4,5
34721.W0084	M 8	60	40	21	4,5
34721.W0085	M 8	60	50	23	4,5
34721.W0100	M10	38	40	21	5,0
34721.W0101	M10	38	50	23	5,0
34721.W0102	M10	60	40	21	5,0
34721.W0103	M10	60	50	23	5,0
34721.W0104	M10	75	40	21	5,0
34721.W0105	M10	75	50	23	5,0
34721.W0120	M12	50	40	23	6,0
34721.W0121	M12	50	50	25	6,0
34721.W0122	M12	75	40	23	6,0
34721.W0123	M12	75	50	25	6,0
34721.W0124	M12	100	40	23	6,0
34721.W0125	M12	100	50	25	6,0
34721.W0126	M12	125	40	23	6,0
34721.W0127	M12	125	50	25	6,0



A Range of features to suit your application

To ensure you select the most suitable levelling feet for your application consider the following questions:

- Tilting or fixed?
- Material required - steel, stainless or plastic?
- Load carrying capacity - light, medium or heavy duty?
(Review the quoted load capacities in the individual product tables).
- Bolt down feature required?
- Threaded or plastic insert required for mounting?
- Optional extras: hygiene seal, rubber pad, (subject to minimum quantity and selected model).

Product selection

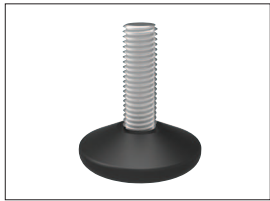

Fixed feet



Articulating levelling feet

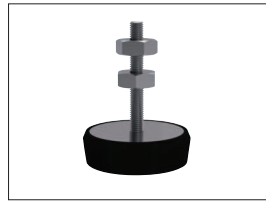

Machine mounts



Fulcrum screw

Key Types

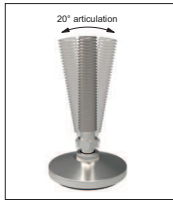

Articulation



Standard nylon base



Anti-slip base



Bolt down base



Hygienic seal

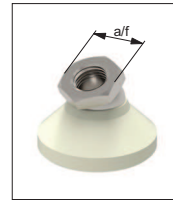

Hex for easy installation

Available features



Steel thread - Nylon base



Stainless thread - Nylon base



Steel thread - Steel base

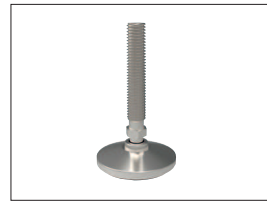

Stainless thread - Stainless base

Materials



Weldable insert

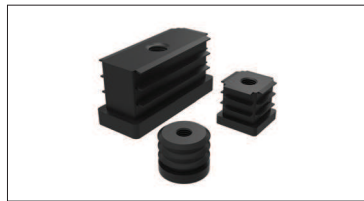

Hollow section insert

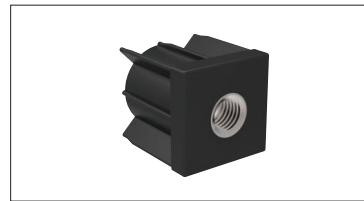

Hollow section bushed insert

Mounting inserts



For applications under greater loads and requiring increased precision of adjustment see our range of Precision Height Adjusters.



For applications exposed to extreme vibrations see our range of Anti-Vibration Mounts.

Additional technical information