

593-801 to 885

14



PART NUMBERING SYSTEM FOR SERIES 14 ASSEMBLIES

K14- 131.025 X X X X

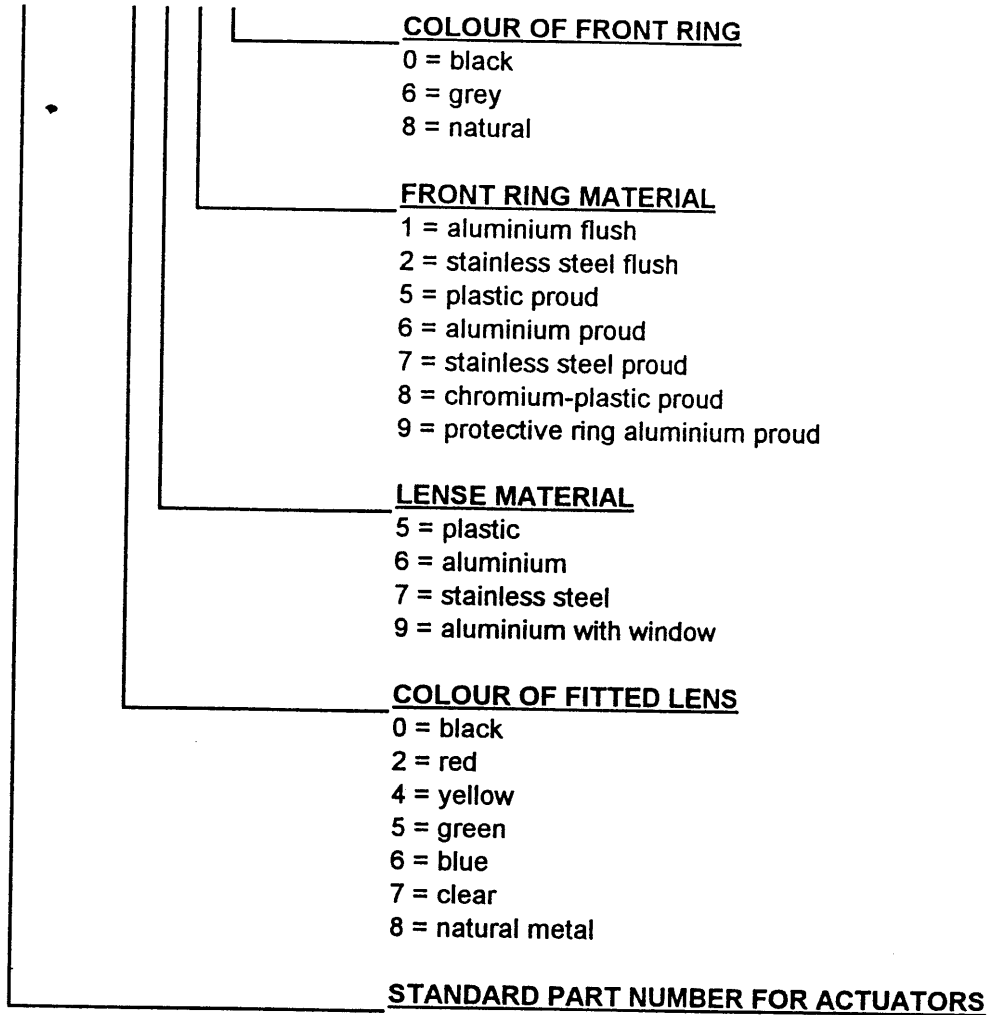

Example of the comprising parts that make up an assembly

K14-131.0255518 = 14-131.025 + 704.602.5 + 704.955.1 + 704.609.9

K14-040.0052550 = 14-040.005 + 704.602.2 + 704.600.0 + 704.609.9

Example of part number system for flush mount switch

Momentary red pushbutton proud mount 1 C/O, aluminium front ring : K14-131.0252568

Momentary red pushbutton proud mount 1 C/O, aluminium flushmount bezel: K14-131.0252518

General Notes

The illuminated pushbuttons with **hoseproof front (IP 67)** of the series 14 combine the robust actuators of series 04 with snap-action, low-level switching elements of series 01, 31, etc. For technical data see pages 2-4. In addition to the standard contacts (gold-plated silver), silver contacts can also be ordered. The front dimension of these units is 29 mm dia.

Mounting

Mounting from the front through the mounting hole is assured even when the wiring has already been attached (mounting dimensions and spacing see pages 5-9). The pushbuttons are screwed to the panel by means of a front ring and prevented from twisting by two screws. To ensure correct positioning of the pushbuttons we can provide a positioning insert on request. The universal terminals of the low-level switching elements permit them to be mounted on printed circuit boards (PCB). These terminals are also suitable for dip soldering. For these terminals we can also supply a plug-in base which, when soldered on to the board, enables the switch to be plugged in.

Lenses

The flat lenses, made of polyamide, are obtainable in various colours, as well as translucent or transparent.

Marking

For engravings, hot stamping and film inserts, see under "Marking" on pages 31 and 32.

Illumination

Perfect illumination of the different coloured lenses is assured by lamps T 5,5 (6-60 V). **If the supply voltage is above 110 V and the lamp voltage is 60 V, an external dropping resistor or capacitor must be used.** Multi-LEDs T 5,5 (6, 12, 24, 48 V) are available in the colours red, yellow and green. **Due to the high surface temperature, resistors may not be soldered direct to the terminals of the pushbuttons.** See under "Lamp accessories" on page 27.

Position indicating

When a switch with maintained action is actuated, the lens remains in the depressed position mechanically. The state of the switch is apparent at all times from the position of the lens.

How to order

14-XXX.0XX

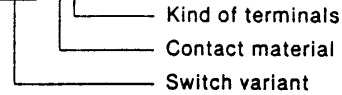

Example:

- Illuminated pushbutton; momentary action, gold-plated silver contact; soldering terminals; 1 switching element
14-131.025
- Lens red, transparent
704.602.2
- Front ring; aluminium, natural anodized
704.600.1
- Marking plate; white, translucent
704.609.9

*All dimensions in mm.
We reserve the right to modify technical data.*

Indicator

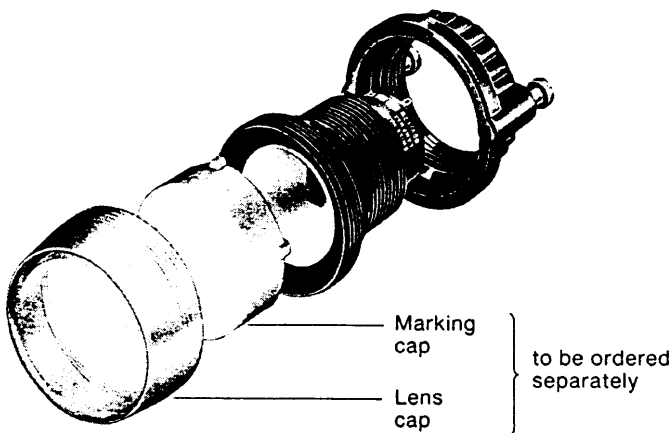

Pushbutton Illuminated pushbutton

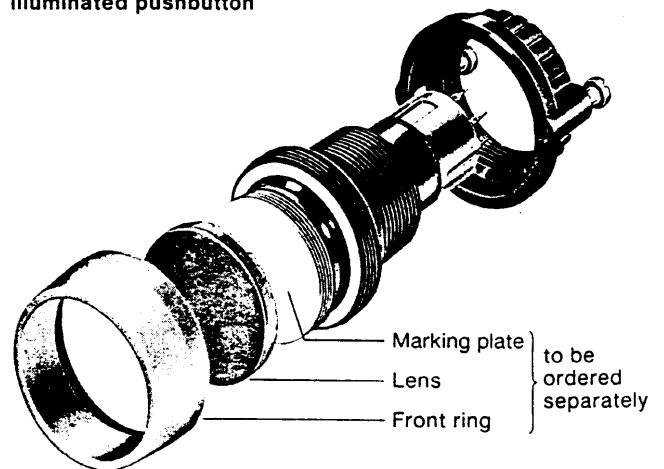

Resistance to vibration (sinusoidal)

10 g at 10–2000 Hz, amplitude 1,5 mm as per IEC 68-2-6

Shockproof (single impact, semi-sinusoidal)

15 g for 11 ms as per IEC 68-2-27

Actuator case

Polyamide

Switch case

DAP (diallyl phthalate), heat-resistant and self-extinguishing

Degree of protection of front as per IEC 529

IP 67

Approvals

- SEV 250 VAC/5 A
- CSA 300 VAC
- UL

- Germanischer Lloyd
- ÖVE
- VDE
- Russian Marine Register

Dimensions refer to page 10

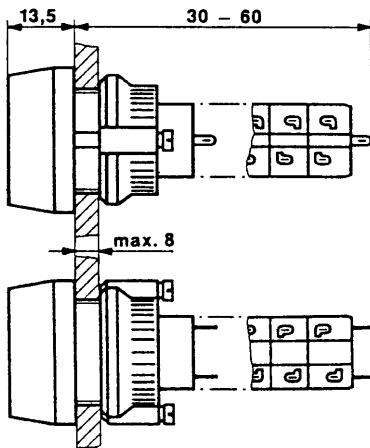

Snap-action switching element

Indicator, illuminated pushbuttons

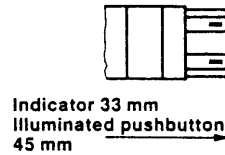
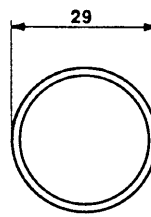

Plug-in terminals 2,8 mm

Dimensions refer to page 11

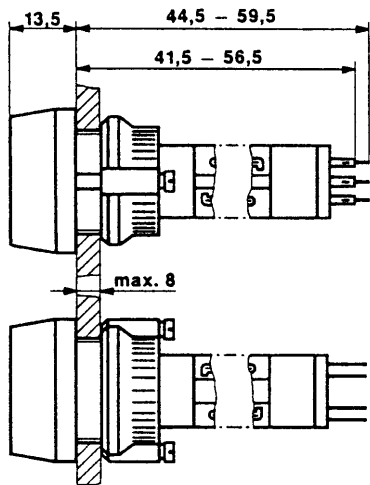

Diode matrix "M"

Indicator, illuminated pushbuttons

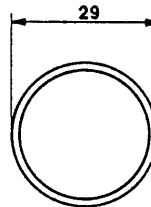

Dimensions refer to pages 17-19

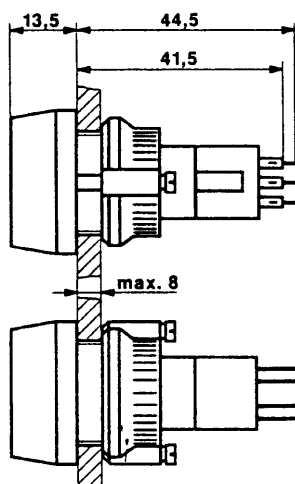

Low-level "LL"

Indicator, illuminated pushbuttons

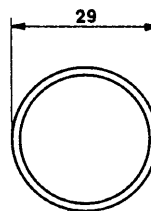

Dimensions

Dimensions refer to page 19

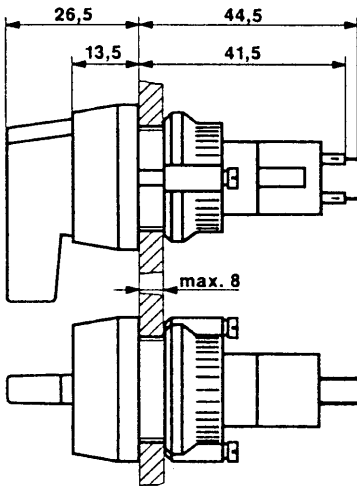

Lever-operated switch

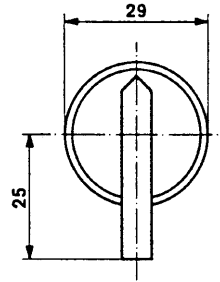

Low-level "LL", EH/EH2

Dimensions refer to page 20

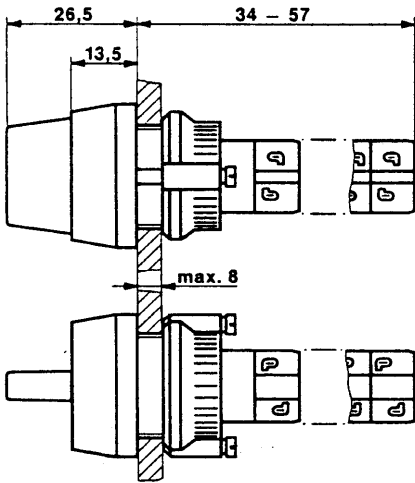

Switch operated by a short lever

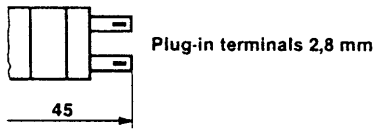
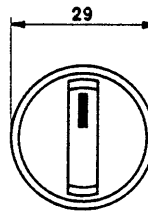

Snap-action switching element

Dimensions refer to page 21

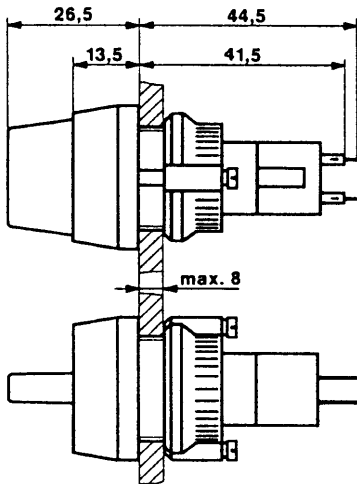

Switch operated by a short lever

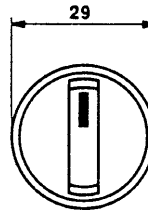

Low-level "LL"

For standard pushbuttons

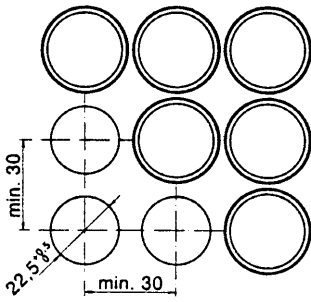

For pushbuttons prevented from twisting

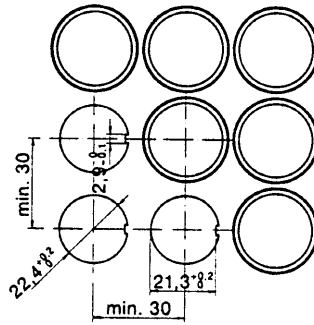

For pushbuttons with positioning insert

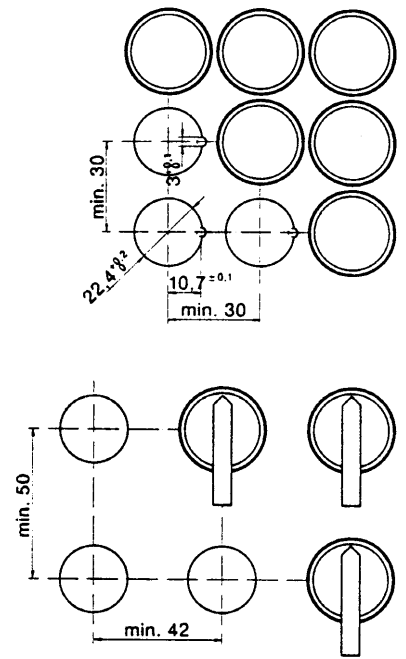

Indicator, Illuminated Pushbuttons (IP 67) with Snap-action Switching Element and Diodes (1 N 4007)

14 M

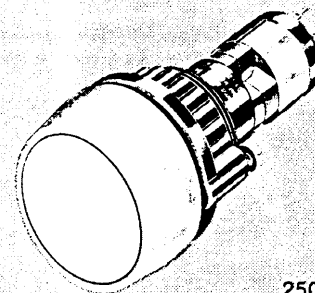

250 VAC, 5 A

Dimensions see page 5

Lens, marking plate, marking cap and front ring to be ordered separately

Description	Number of diodes	Momentary action	Maintained action	Type No.	Terminals			Depth mm
					Case colour	Contact material	Terminals	
Indicator with diodes	1	-	-	14-741.	0	0	6	44,5
	2	-	-	14-742.	0	0	6	44,5
Illuminated pushbutton 1 switch element and diodes	1	x	-	14-743.	0	2	9	52
	2	x	-	14-744.	0	2	9	52
Illuminated pushbutton 2 switch elements and diodes	1	x	-	14-745.	0	2	9	59,5
	2	x	-	14-746.	0	2	9	59,5
Illuminated pushbutton 1 switch element and diodes	1	-	x	14-747.	0	2	9	52
	2	-	x	14-748.	0	2	9	52
Illuminated pushbutton 2 switch elements and diodes	1	-	x	14-749.	0	2	9	59,5
	2	-	x	14-750.	0	2	9	59,5

For lamps see page 26

11.92

Indicator, Illuminated Pushbuttons (IP 67) with Low-level Switching Element

14 LL

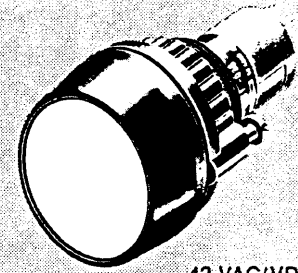

42 VAC/VDC, 100 mA

Dimensions see page 5

Lens, marking plate, marking cap and front ring to be ordered separately

∅ 29 mm

Description	Momentary action	Maintained action		Type No.				Depth mm
					Case colour	Contact material	Terminals	
Indicator (The total length is the same as that of the illuminated pushbutton)	-	-		14-031.	0	0	6	44,5
Illuminated pushbutton 1 normally open contact	x	-		14-435.	0	3	6	44,5
Illuminated pushbutton 2 normally open contacts	x	-		14-431.	0	3	6	44,5
Illuminated pushbutton 1 normally closed contact	x	-		14-436.	0	3	6	44,5
Illuminated pushbutton 2 normally closed contacts	x	-		14-432.	0	3	6	44,5
Illuminated pushbutton 1 normally closed contact 1 normally open contact	x	-		14-433.	0	3	6	44,5



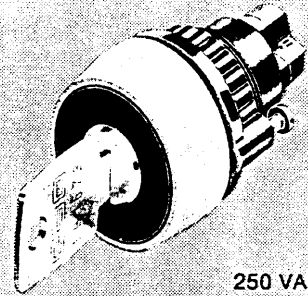

For lamps see page 26

Safety Keylock Switches (IP 65) with Snap-action Switching Element

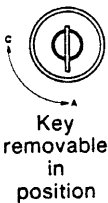

250 VAC, 5 A

Dimensions see page 6

Description		Type No.	Case colour	Contact material	Terminals	Lock type	Depth mm	Depth with plug-in terminals mm
Keylock switch Position A basic position Position C maintained action 1 switching element		A C	14-135.	0		K	34,5	41,5
		A -	14-235.	0		K		
		- C	14-335.	0		K		
Keylock switch Position A basic position Position C maintained action 2 switching elements		A C	14-136.	0	5	K	42	
		A -	14-236.	0	5	K		
		- C	14-336.	0	5	K		
Keylock switch Position A basic position Position C maintained action 3 switching elements		A C	14-137.	0	5	K	49,5	
		A -	14-237.	0	5	K		
		- C	14-337.	0	5	K		
Keylock switch Position A basic position Position C maintained action 4 switching elements		A C	14-138.	0	5	K	57	
		A -	14-238.	0	5	K		
		- C	14-338.	0	5	K		

Silver = 1, gold-plated silver = 2
 Plug-in terminals 2,8 x 0,5 mm = 2, soldering terminals = 5

Safety lock (Index K)

Single locks (2 positions)

10 different locks with standard numbers 1001-1010. If the lock number is not specified, we will supply No. 1001. An additional 690 locks with numbers 1011-1700 are available on request. For numbers 1001-1700 no master key can be supplied. Two keys are supplied with each keylock switch.

Spare keys for KABA safety locks may be ordered by quoting No. 14-987 (please state the lock number).

Combined locking systems

Information supplied on request.

Safety Keylock Switches (IP 65) with Low-level Switching Element

14 LL

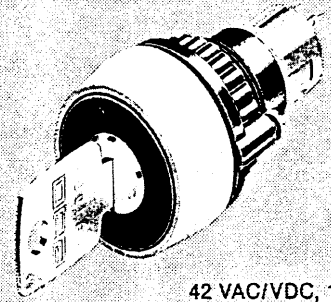

42 VAC/VDC, 100 mA

Dimensions see page 6

Description	Key removable in position	Type No.	Case colour	Contact material	Terminals	Lock type	Depth mm
Keylock switch Position A basic position Position C maintained action 2 normally open contacts		A — C 14-411. 14-414. 14-417.	0 0 0	3 3 3	6 6 6	K K K	44,5 44,5 44,5
Keylock switch Position A basic position Position C maintained action 1 normally open contact		A — C 14-412. 14-415. 14-418.	0 0 0	3 3 3	6 6 6	K K K	44,5 44,5 44,5
Keylock switch Position A basic position Position C momentary action 2 normally open contacts		A — C 14-437.	0	3	6	K	44,5
Keylock switch Position A basic position Position C momentary action 1 normally closed, 1 normally open contact		A — C 14-438.	0	3	6	K	44,5

Safety lock (Index K)

Single locks (2 positions)

10 different locks with standard numbers 1001-1010. If the lock number is not specified, we will supply No. 1001. An additional 690 locks with numbers 1011-1700 are available on request. For numbers 1001-1700 no master key can be supplied. Two keys are supplied with each keylock switch.

Spare keys for KABA safety locks may be ordered by quoting No. 14-987 (please state the lock number).

Combined locking systems

Information supplied on request.

Lever-operated Switches (IP 65) with Low-level Switching Element

14 LL

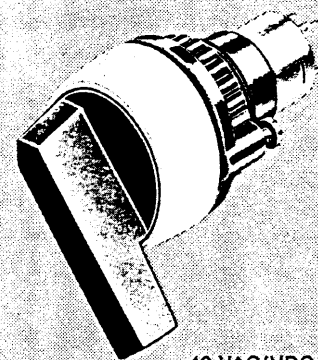

42 VAC/VDC, 100 mA

Dimensions see page 7

Description		Type No.	Terminal configuration				Depth mm
			Case colour	Contact material	Terminals	Lever black	
Lever-operated switch Position A basic position Position C momentary action 45° 2 normally open contacts		14-565	0	3	6	0	44,5
Lever-operated switch Position A basic position Position C momentary action 45° 2 normally closed contacts		14-566	0	3	6	0	44,5
Lever-operated switch Position A basic position Position C momentary action 45° 1 normally closed contact 1 normally open contact		14-567	0	3	6	0	44,5
Lever-operated switch Position A basic position Position C momentary action 45° 1 normally closed contact 1 normally open contact (short-circuiting)		14-568	0	3	6	0	44,5
Lever-operated switch Position A basic position Position C maintained action 90° 2 normally open contacts		14-570	0	3	6	0	44,5
Lever-operated switch Position A basic position Position C maintained action 90° 2 normally closed contacts		14-571	0	3	6	0	44,5
Lever-operated switch Position A basic position Position C maintained action 90° 1 normally closed contact 1 normally open contact		14-572	0	3	6	0	44,5
Lever-operated switch Position A basic position Position C maintained action 90° 1 normally closed contact 1 normally open contact (short-circuiting)		14-573	0	3	6	0	44,5

Lever black, other colours on request





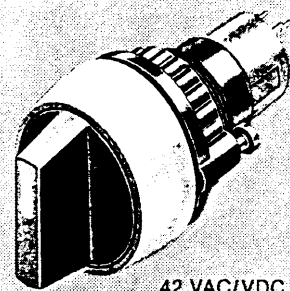

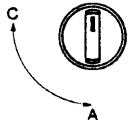

Switches Operated by a Short Lever (IP 65) with Low-level Switching Element

14 LL















42 VAC/VDC, 100 mA

Dimensions see page 7

Description		Type No.	Case colour	Contact material	Terminals	Lever black	Depth mm
Switch operated by a short lever Momentary action 45° 2 normally open contacts		14-515.	0	3	6	0	44,5
Switch operated by a short lever Momentary action 45° 2 normally closed contacts		14-516.	0	3	6	0	44,5
Switch operated by a short lever Momentary action 45° 1 normally closed contact 1 normally open contact		14-517.	0	3	6	0	44,5
Switch operated by a short lever Momentary action 45° 1 normally closed contact 1 normally open contact (short-circuiting)		14-518.	0	3	6	0	44,5
Switch operated by a short lever Maintained action 90° 2 normally open contacts		14-520.	0	3	6	0	44,5
Switch operated by a short lever Maintained action 90° 2 normally closed contacts		14-521.	0	3	6	0	44,5
Switch operated by a short lever Maintained action 90° 1 normally closed contact 1 normally open contact		14-522.	0	3	6	0	44,5
Switch operated by a short lever Maintained action 90° 1 normally closed contact 1 normally open contact (short-circuiting)		14-523.	0	3	6	0	44,5

Lever black, other colours on request

Description	colour	Type No.	
Indicators			
Transparent lens cap	red yellow green blue clear	704.603.2 704.603.4 704.603.5 704.603.6 704.603.7	
Translucent, knurled marking cap	white	704.608.9	
Transparent, knurled marking cap (for neon lamps)	clear	704.608.7	
Illuminated pushbuttons			
Front ring of aluminium	natural anodized black anodized	704.600.1 704.600.1A	
Front ring of plastic	black light grey	704.600.0 704.600.6	
Front ring, of chromium-treated plastic		704.600.4	
Front ring of chromium-plated nickel steel		704.600.9	

Description	Colour	Type No.	
Translucent marking plate	<ul style="list-style-type: none"> ● opaque ● black white 	704.609.0 704.609.9	
Transparent, ribbed marking plate (for neon lamps)	clear	704.609.7	
Translucent, ribbed marking cap for raised lenses	<ul style="list-style-type: none"> ● black white 	704.610.9	
Transparent, ribbed marking cap for raised lenses (for neon lamps)	clear	704.610.7	
Raised, transparent lens	red yellow green clear	704.611.2 704.611.4 704.611.5 704.611.7	

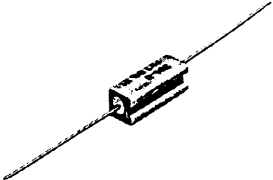
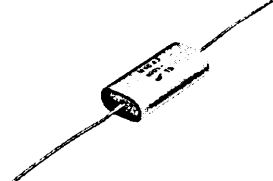
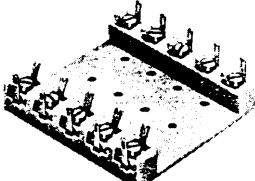
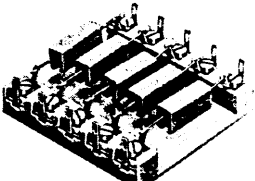
Description			Type No.	
Series resistor to reduce the lamp voltage. Use with 60 V/20 mA lamp rating	110 V 125 V 145 V 230-240 V	2,7 kΩ 3,3 kΩ 4,7 kΩ 10 kΩ	02-904.0 02-904.1 02-904.3 02-904.7	
Capacitor to reduce the lamp voltage. Use with 60 V/20 mA lamp, 50 Hz	230 V	0,3 μF	02-917.0	
Empty terminal plate for wiring resistors or capacitors	5 spaces 10 spaces 15 spaces 20 spaces		02-912.1 02-912.2 02-912.3 02-912.4	
Terminal plate fitted with resistors or capacitors	2,7 kΩ 110/60 V 5 spaces 10 spaces 15 spaces 20 spaces 3,3 kΩ 125/60 V 5 spaces 10 spaces 15 spaces 20 spaces 10 kΩ 230-240/60 V 5 spaces 10 spaces 15 spaces 20 spaces 0,3 μF 230/60 V 5 spaces 10 spaces 15 spaces 20 spaces		02-913.10 02-913.20 02-913.30 02-913.40 02-913.11 02-913.21 02-913.31 02-913.41 02-913.17 02-913.27 02-913.37 02-913.47 02-914.10 02-914.20 02-914.30 02-914.40	

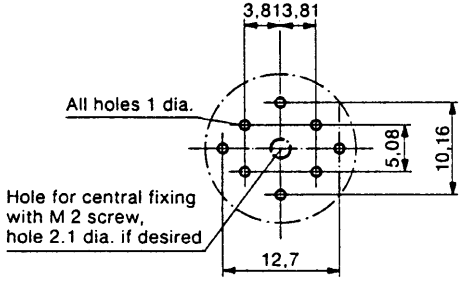
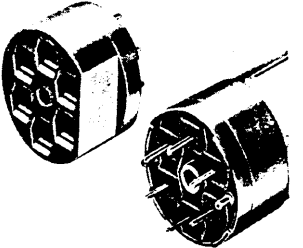
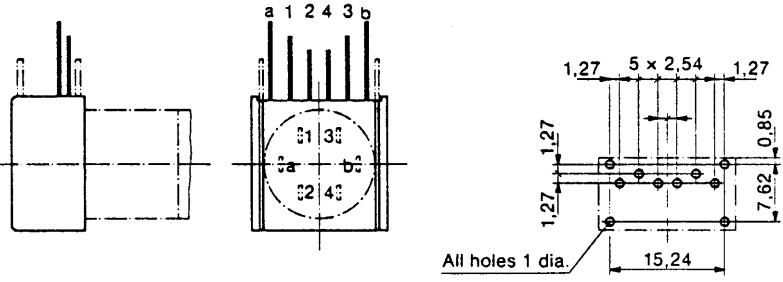
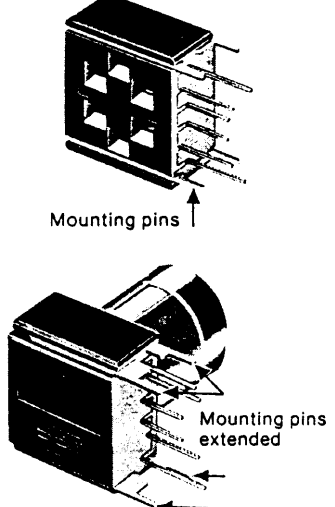
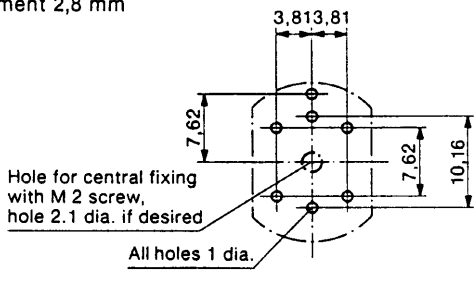
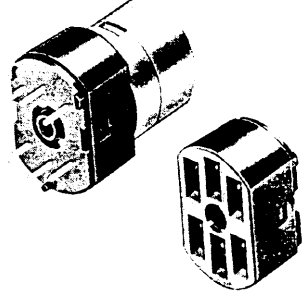
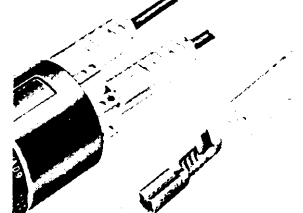
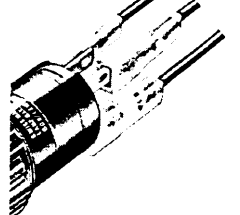
Description	Type No.	
<p>Axial PCB plug-in base for low-level switching elements 16,4 mm dia. x 9,8 mm high</p> 	31-940	
<p>Right-angled PCB plug-in base for low-level switching elements 17,9 mm square x 8,4 mm high</p> <p>The withdrawable mounting pins allow the distance between the PCB plug-in base and the board to be varied by up to 3 mm</p> 	31-941	
<p>Axial PCB plug-in base for axial snap-action switching element 2,8 mm 17,8 mm dia. x 9,8 mm high</p> 	31-942	
<p>Connector for low-level switching elements</p>	31-945	
<p>Insulation socket for connector 31-945</p>	31-928	
<p>Connector for axial snap-action switching element 2,8 mm</p>	31-946	
<p>Insulation socket for connector 31-946</p>	31-929	

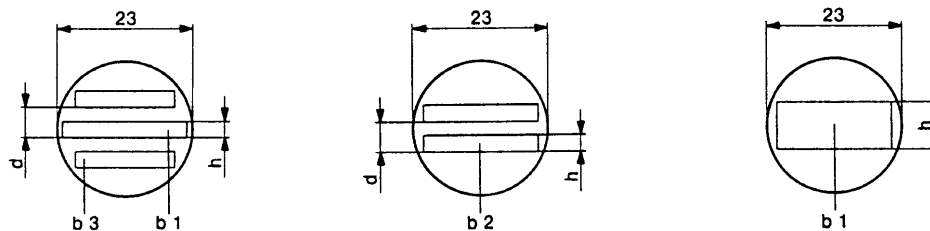

Indicator - Engraving of marking cap

All marking plates and marking caps are engraved in lettering to DIN 1451, with black or white filling.

Can also be supplied with standard lettering or symbols.

For symbols see series 04.

Lettering to be engraved should be specified on a separate order sheet.
(obtainable from us on request.)

Height of letters mm	Number of lines	Number of letters per line approx.			Line spacing mm
		b1	b2	b3	
3	3	11	10	9	4,6
4	2	8	7	-	6,6
8	1	4	-	-	-

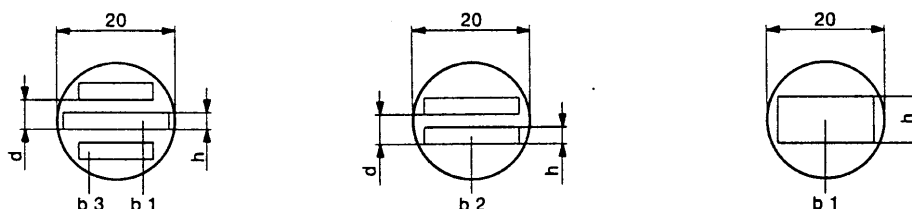

Pushbutton/Illuminated pushbuttons - Engraving of marking plate or raised marking cap

All marking plates and marking caps are engraved in lettering to DIN 1451, with black or white filling.

Can also be supplied with standard lettering or symbols.

For symbols see series 04.

Lettering to be engraved should be specified on a separate order sheet.
(obtainable from us on request.)

Height of letters mm	Number of lines	Number of letters per line approx.			Line spacing mm
		b1	b2	b3	
3	3	9	9	7	4,6
4	2	7	6	-	6,6
8	1	3	-	-	-