

LQH5BPH6R8NT0#

*# indicates a package specification code.



< List of part numbers with package codes >
LQH5BPH6R8NT0L , LQH5BPH6R8NT0K

Shape

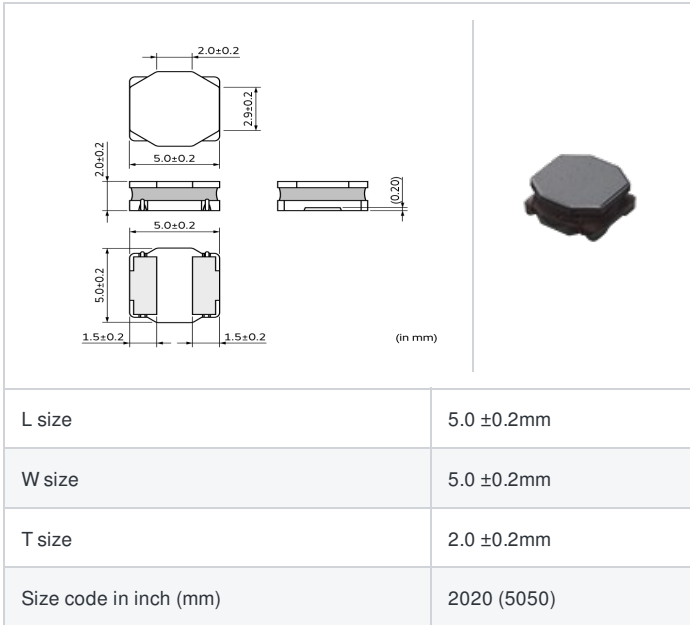

Notes

When rated current is applied to the products, inductance will be within ±30% of nominal inductance value.
When rated current is applied to the products, the temperature rise caused by self-generated heat shall be limited to 40 °C max. with outside temp under 85 °C, 20 °C max. with outside temp. between 85 °C to 105 °C

References

Packaging code	Specifications	Minimum quantity
L	φ180mm Embossed taping	500
K	φ330mm Embossed taping	3000

Mass (Typ.)	
1 piece	0.22g

Specifications

Inductance	6.8μH ±30%
Inductance test frequency	100kHz
Rated current (I _{sat}) (Based on Inductance change)	2.5A
Rated current (I _{temp}) (Based on Temperature rise)	1.65A(Ambient temp.85°C) 0.96A(Ambient temp.105°C)
Max. of DC resistance	0.0996Ω
Avg. of DC resistance	0.083Ω ±20%
Self resonance frequency (min.)	30MHz
Operating temperature range (Self-temperature rise is included)	-40°C to 125°C
Operating temperature range (Self-temperature rise is not included)	-40°C to 105°C
Class of magnetic shield	Magnetic Resin
Series	LQH5BPH_T0

Attention

- This datasheet is downloaded from the website of Murata Manufacturing Co., Ltd. Therefore, it's specifications are subject to change or our products in it may be discontinued without advance notice. Please check with our sales representatives or product engineers before ordering.
- This datasheet has only typical specifications because there is no space for detailed specifications. Therefore, please review our product specifications or consult the approval sheet for product specifications before ordering.