

# HSEUREG07201

720W Programmable DC Lab Power Supply, TS35mm DIN-Rail

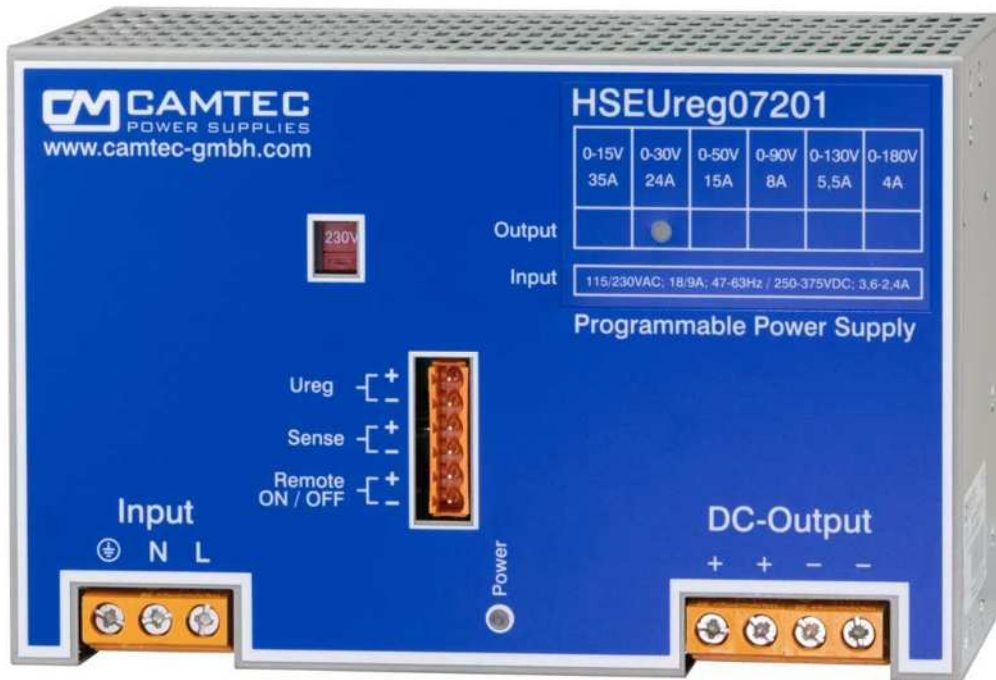

## Specification:

- Voltage programming from 0V
- Multi interface 0-10V & 0-20mA
- Sense & Shutdown (remote ON/OFF)
- N+1 parallel operation
- Natural convection
- Precise dynamic response on load change
- Designed for long life under full stress
- Strong input filters
- High reliability, shock & vibration proof
- Over Voltage and continuous short circuit protection
- EMI/EMS EN61000-6-2,3, EN55032 class B
- EN61010-1, EN61010-2-201, EN62368-1

Models	Voltage Programmable	Current
HSEUREG07201.015	0 – 15Vdc	35A
HSEUREG07201.030	0 – 30Vdc	24A
HSEUREG07201.050	0 – 50Vdc	15A
HSEUREG07201.090	0 – 90Vdc	8,0A
HSEUREG07201.130	0 – 130Vdc	5,5A
HSEUREG07201.180	0 – 180Vdc	4,0A





### Technical Concept

**The Camtec HSEUREG models are high-precision lab power supplies „Made in Germany“. These power supplies are designed for power systems in the testing automation and for industrial use.**

For more than 25 years the Camtec Power Supplies manufactures high-end switch mode power supplies in Germany. A field breakdown of below 0,004% over a 10-year period under review approves our ambitious quality concept. Each manufactured Camtec product passes 100% tests for each detailed function and a full-load Burn-In test.

Although it is not required from the safety norms our production applies a routine safety test to each manufactured device, even if it is an extra low-voltage model. The components in the assembled device pass stress aging to achieve an even level and to prevent from delayed failures. Our internal product engineering guidelines provide a clear target: Camtec product reputation must say „mount and forget“. Quality is never a mere promise for our team.

The HSEUREG laboratory power supplies provide low noise and ripple, a very quick programming, and a precise setting at high load changes. With an efficiency up to 90% the devices are highly energy efficient.

Equipped with high-end capacitors of outstanding lifetime our power supplies guarantee a very long and reliable operation time. The circuit design of the HSEUREG Series allows cope playing with complex loads. The internal protection circuits protect the power supply and the connected system, even in exceptional situations. The HSEUREG series is protected from high transients by strong filters with high energy efficiency. All inputs and outputs are electrically isolated. The design specifications call for the highest standards of safety and interference suppression.

The 480W and 720W models provide natural convection. The 1kW models use a forced air-cooling system with a fan. In selecting the fan, as with all our power supplies, in our opinion we use with the German manufacturer EBM Papst the highest quality and most reliable devices in the world market.

#### Design Conception

The HSEUREG power supply series realizes high programmable power in a space-saving housing. Latest generation electrical devices relate to the high reliability of all CAMTEC products. The CAMTEC philosophy is, to employ 125°C low ESR ultra long-life capacitors where expedient to achieve a superior lifetime of the product. The HSEUREG power supply is made for high reliable and demanding industrial applications like galvanic systems, professional DC-drives, and complex test benches

#### Programming Performance

THE HSEUREG power supply is very equal to a typical laboratory power supply – just without its displays. It is designed for automated industrial test benches in a 24/7 operation. The HSEUREG provides save and precise down to zero voltage programming. The product is equipped with a multi-functional interface. Thus, the interface can be operated with either 0-10Vdc/20mA or with 0-20mA programming. The burden is 500Ω to ensure interference free operation with controller interfaces. The device features a small latency and a quick all rise time that leads to typical 15ms from zero to Umax programming.

#### Galvanic Isolation

The power supply is galvanic isolated between the input and the output. All features are connected to the DC power outputs.

#### Thermal shutdown

The HSEUREG is featured with a thermal overload shut down and auto recovery behaviour.

#### Over Voltage Protection

Ticker mode and auto recovery

#### Short Circuit Protection

A continuous short circuit does not cause damage to the power supply. The HSEUREG delivers constant current and zero output voltage. It recovers automatically after the short circuit is released.

#### Open Circuit Protection

The HSEUREG series is continuously open circuit protected. The device delivers a stable output voltage and no current. If a load is immediately connected to the device, the power supply stabilizes within 1ms. It does not overshoot the output voltage.

#### Power Up Ramp

The devices have a soft start ramp when powering up. The device does not either overshoot the voltage nor does the output flutter independent if a load is connected or not.

**Technical Table**

AC Input Range	90-132Vac, 184-264Vac (115/230Vac input selector, factory setting is 230Vac)					
AC Input Frequency	47-63Hz					
DC Input Range	250Vdc-375Vdc (input selector set to 230Vac)					
AC Input Rated	115Vac<12.7A 230Vac<7.2A					
DC Input Rated	250Vdc<3.6A 375Vdc<2.4A(input selector set to 230Vac rated)					
DC Voltage Programmable	<b>0 - 15V</b>	<b>0 - 30V</b>	<b>0 - 50V</b>	<b>0 - 90V</b>	<b>0 - 130V</b>	<b>0 - 180V</b>
DC Current Rated +50°C	35.0A	24.0A	15.0A	8.0A	5.5A	4.0A
DC Current Rated +60°C	26.3A	18.0A	11.3A	6.0A	4.1A	3.0A
Power Boost 60s +50°C	38.5A	26.4A	16.5A	8.8A	6.1A	4.4A
Over Voltage Protection	18Vdc	35Vdc	59Vdc	105Vdc	150Vdc	210Vdc
Over Current Protection	40.3A	27.6A	17.3A	9,2A	6.3A	4.6A
Ripple Noise 230Vac 20MHz	40mVpp	50mVpp	100mVpp	150mVpp	200mVpp	300mVpp
Load regulation 0-100%	< ±0.1%	< ±0.1%	< ±0.1%	< ±0.1%	< ±0.1%	< ±0.1%
Sense function	Compensation 2V per lead load, protective electrical separation ≤60Vdc					
Remote Shutdown	protective electrical separation ≤60Vdc					
Analogue Interface	see table, protective electrical separation ≤60Vdc, working impedance = 500Ω					
Accuracy	< ± 1.5% Interface					
Latency Interface	15ms including signal latency for 0-Umax programming					
Start-up Delay	Typ. 250ms					
Softstart	Typ. 100ms					
Start-up from Shutdown	Typ. 250ms					
Response Load Change	<1ms 10-100%, 100-10%					
Base Load	None					
Efficiency 230Vac	90% typical					
Short Circuit Protection	Continuous					
Idling-proof	Yes					
Temperature Control	Yes, thermal shutdown with auto recovery (+60°C, metering distance 50mm)					
Hold Up Time	> 40ms 230Vac					
Inrush Current	< 162A (230Vac) @25°C					
MCB (Miniature Circuit Breaker)	16A curve C @ 230Vac, 25A curve C @ 115Vac					
Cooling	Natural convection					
Ambient Operating Temp.	- 25°C...+60°C, derating 2,5%/°C >50°C					
Ambient Storage Temp.	- 40°C...+85°C					
Environment	Humidity 95% non-condensing @ 25°C, climate class. 3k3, pollution degree 2					
ROHS	2011/65/EU, (EU)2015/863					
REACH	EG No. 1907/2006					
EMI	EN55032 class B, EN61000-6-3					
EMS	EN61000-6-2					
Safety	EN61010-1, EN61010-2-201, EN62368-1, EN60950-1, EN60204-1					
Protection Class I	PE connection required					
Creepage Distance	> 8mm					
Input / Output	Galvanic isolated					
MTBF (IEC61709)	400000h (Meantime Between Failures: statistic time between failures after repairs)					
MTTF (IEC61709)	141102h (Meantime To Failure: statistic time to ever fails)					
Dimensions (HxWxD)	130x200x115mm					
Weight	3,0kg / 6,6lbs					
AC Terminals	Input Screw Terminal 3x AWG22 – AWG6 / 0,5 – 16mm <sup>2</sup> (L,N,PE)					
DC Terminals	Output Screw Terminal 4x AWG22 – AWG6 / 0,5 – 16mm <sup>2</sup> (+ + / - - )					

# Manual und Technical Details

### Programming Time Vout [ms]

Model	0-15V	0-30V	0-50V	0-90V	0-130V	0-180V
Rise Time 0-100%, 10/100% Last, [ms] typ.	15/15	15/15	15/15	15/15	15/15	15/15
Slew Rate 90-10%, 10/100% Last, [ms] typ.	36/3.6	104/10.4	49/4.9	57/5.7	53/5.3	100/10
Output Capacity, [mF] typ.	10.36	10.36	1.85	0.64	0.28	0.28
Interface Latency	15ms including signal latency for 0-Umax programming					

### Analog Interface

Pin	Name	Type	Function	Signal	Remarks
1	Ureg +	Input	Voltage Programming	0-10Vdc/20mA & 0-20mA multi-functional interface	500 Ω working resistance with voltage programming
2	Ureg -	Input			
3	Sense +	Input	Sense Control	none	Compensation max. 2V per load line
4	Sense -	Input			
5	Remote +	Input	External Shutdown Remote ON/OFF	Open Collector or Switch	Voltage drop <1V with typical 2.3mA
6	Remote -	Input			

### Programming Interface Ureg

The standard programming of the HSEUREG Series is an analogue interface. The output voltage is linearly proportional to the adjusted analogue control signal. If the control signal 0V applies the power supply delivers 0V at the output. The power supply is already working from 0V output voltage and low load with high precision.

The analogue inputs are non-floating. The mass is connected to the DC negative output. The burden of the interface is 500Ω. 0-10V programming requires 20mA current. The latency to full compensation of V/C on the interface from 0-100% is typically 15ms for all HSEUREG models.

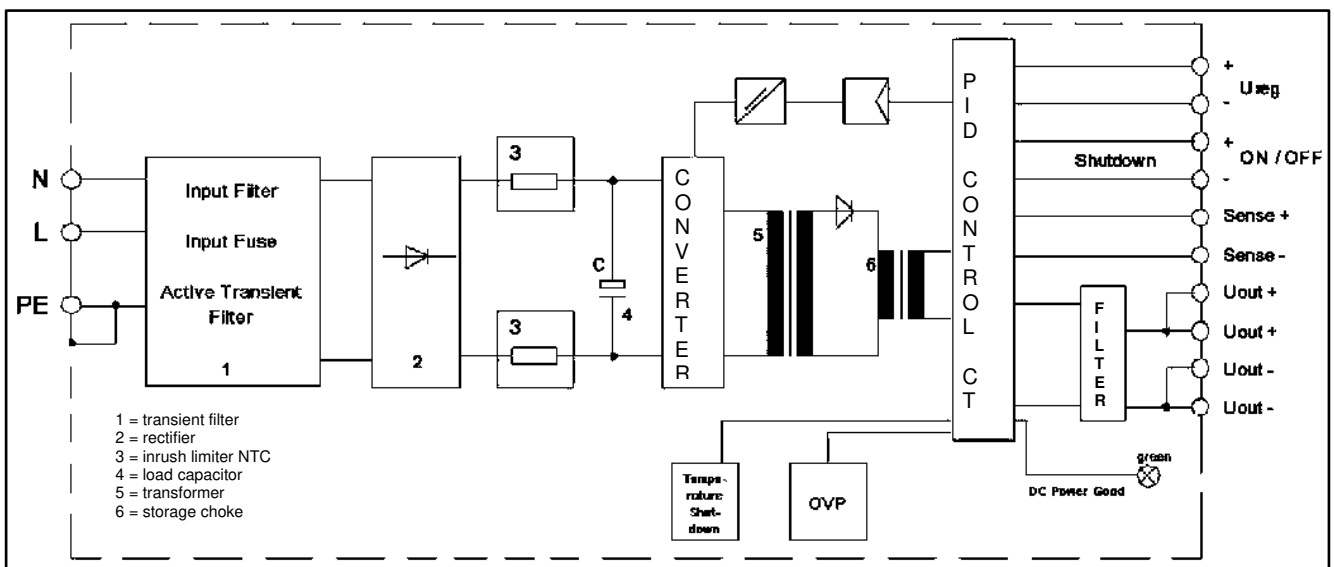
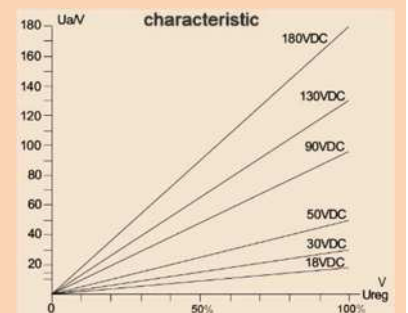

## Compensation of Load Line Voltage Drop (Sense +/-), standard operation mode

The HSEUREG power supply has a Sense Mode to compensate for the voltage drop over long load lines. The compensation amounts to a maximum of 2V per load line. Under certain circumstances, it can be expected to apply more complicated external interference suppression.

Sense operation:

Connect the sense lines directly to the load. Pay attention to the polarity of plus and minus of the load to prevent damage to the power supply. To avoid interference, twist the sense lines. To reduce inductive effects, we recommend that the load lines position is close to each other. To supply a pulsating load, the use of an electrolytic capacitor and a ceramic capacitor has proved. The internal Over Voltage Protection (OVP) of the power supply controls the DC power directly to the DC output terminals. In case of an error the OVP acts automatically (see OVP values corresponding technical table page 3).

**Local Sensing:** When the sense lines are not connected to the load connect directly to the power outputs to allow proper operation.

**Remote Sensing Schematics:** Although the HSEUREG sense block is simpler, it applies to the shown schematics. Please note that the HSEUREG has no AUX connection feature and that the sense block has only +/- connections. We recommend twisted sense lines.

### Local Sensing:

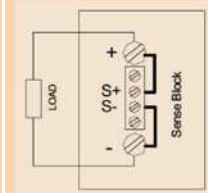

### Remote Sensing:

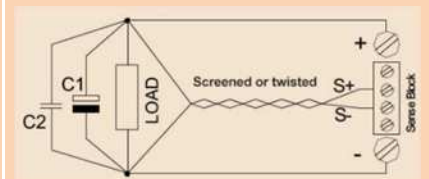

## Compensation of Load Line Drop Voltage (Sense +/-), battery charger operation mode

### Remote Sensing as a battery charger

If the HSEUREG power supply unit is used as a battery charger, it is recommended to refrain from sensing. It can lead to severe damage to the power supply, if the polarity of the sense line is confused (field experience: such error often occurs when system service is required, e.g., when the batteries are changed). If it is necessary to use sensing, proceed as described in the figure below. Proven approaches are 250mA for the fuses and 3...5A load capacity of diodes.

Although the HSEUREG sense block is simpler, it applies to the below schematics. Please note that the HSEUREG has no AUX connection feature and that the sense block has only +/- connections. We recommend twisted sense lines.

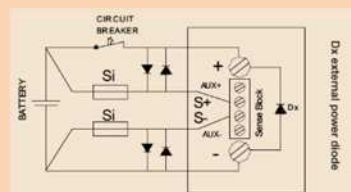
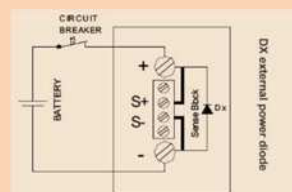

## External Shutdown (SD)

The power supply is set to the Shutdown mode, when the control input is either shorted via a relay contact, a switch contact or an NPN transistor with open collector (voltage drop <1V, current typ. 2,3mA).

If the shutdown repeals the power supply starts with a typical delay of 250ms.

Using the soft start, the current and the voltage rises within 100ms continuously to the default set values. Note that the input is not floating. The common ground is internally connected to the Sense-. The Sense- is connected to DC-minus output.





## Temperature Derating

The maximum ambient temperature during operation is + 60°C. If the over temperature protection is activated, the power supply is switched off.

The measuring point is 50mm outside the power supply. The power supply unit starts automatically when it has cooled down.

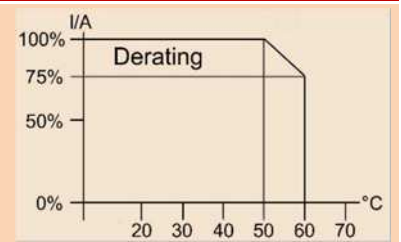

## Series Operation

Two or more units of the same model and output voltage can be operated up to a total voltage of 240Vdc in series. Due to the dielectric strength of the internal components used, only the models with an output voltage of 90Vdc and later are approved for series operation. Other power supplies are not approved for series operation above 60Vdc.

If the units are remotely controlled via the analogue interface it is compulsory to use a potential-free control voltage!

## Parallel Operation & N+1 Decoupling

To increase the overall power of the power supply, two or more devices of the same model with the same output voltage may be operated in parallel. We recommend using a busbar for the DC power connector. Make sure that the cable lengths and cable cross-sections of all power supplies to the busbar or to the star point are identical. Allow proper connection for low contact resistance. If you want to use the sensing function, connect it also to the star point or busbar. To avoid measurement errors, select the line length from the neutral point or from the busbar to the load as short as possible and use the maximum possible conductor cross-section.

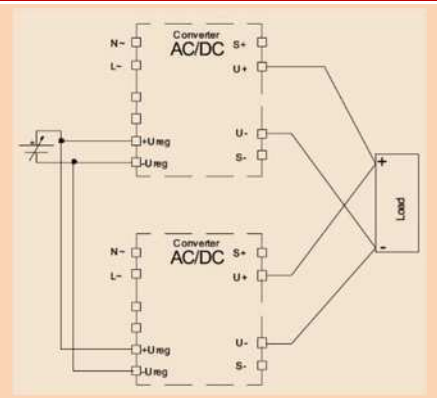

The HSEUREG models have no internal O-ring diode, to operate the devices N+1 redundant.

## Coating Option

We offer the HSEUREG-series with optional coating. It is to be used in e.g. dusty, dirty, high humidity, or in awaiting quick temperature changes. Short circuit and corrosion at print board lines and at solder points can be prevented. The coat itself is a transparent acrylic resin. Peters SL 1306 N-FLZ (transparent) IEC60216-1 2001, IPC-CC-830B, UL listed as permanent coating FileNo.: E80315 , UL94V-0

## Electrical Safety (Factory-Test / Field-Test Owner)

	T	A	B	C <sup>1)</sup>
Type Test	60s	2500Vac	3000Vac	500Vdc
Factory Test	5s	2000Vac	2000Vac	500Vdc
Field Test	2s	2000Vac	2000Vac	500Vdc
Cut-off current setting	>20mA	>20mA	>1mA	

<sup>1)</sup> ≥90Vdc = 2000Vdc

Type and factory test are the manufacturer. While repeating damage can happen to the power supply unit. For the field test (owner) follow the below instruction:

- Use suitable test equipment, raising the voltage slowly
- Short circuit L1 and N, and all the DC output terminals.
- Use only test voltages of 50/60Hz. The outputs are unearthed and therefore they have no resistance to GND/PE.
- If the residual voltage is ≥60Vdc, observe the safety standards. Use only specially insulated screwdriver to trim the Ua/Ia.

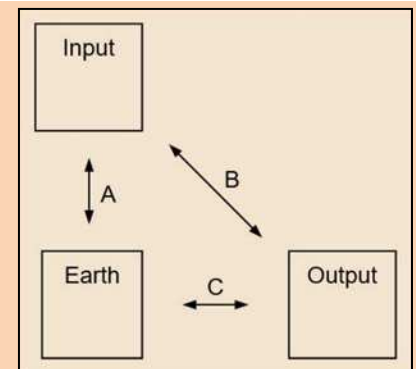

## Mechanics

### ST-HD Baseplate Cooling & Temperature Management

The temperature management of the HSEUREG series provides a direct dissipation of the main energy losses. The internal coolers of the output diodes and the power FETs connect to the back-plate cooler. It is possible to dissipate about 40 – 50% of the energy losses out of a system while using the Baseplate cooling bundle 2201002001 to hard mount the unit to a plane and heat conductive surface.

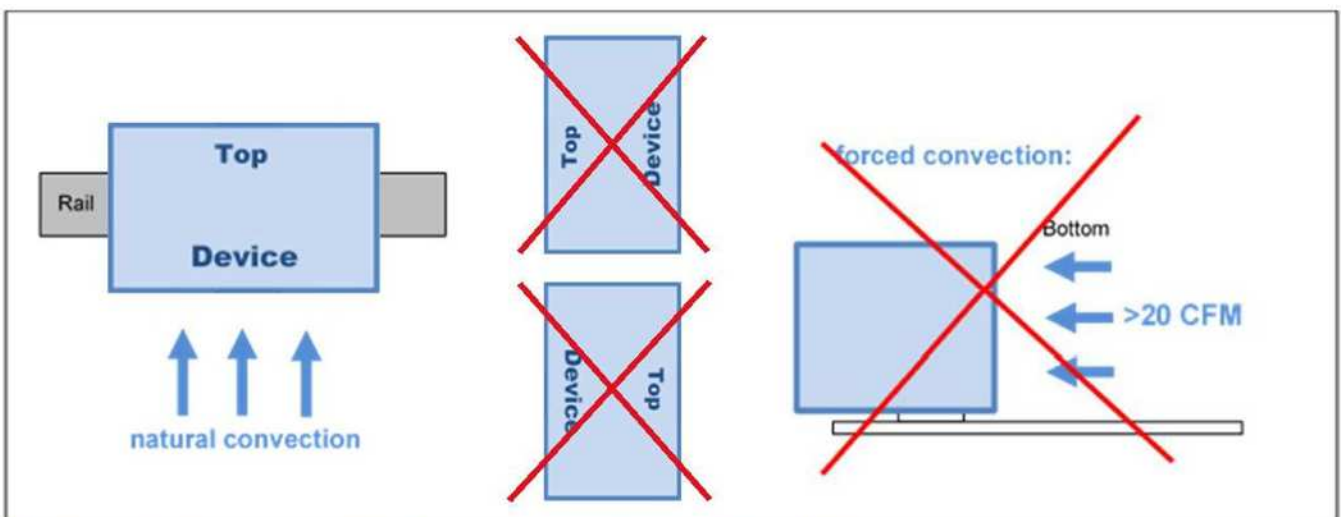
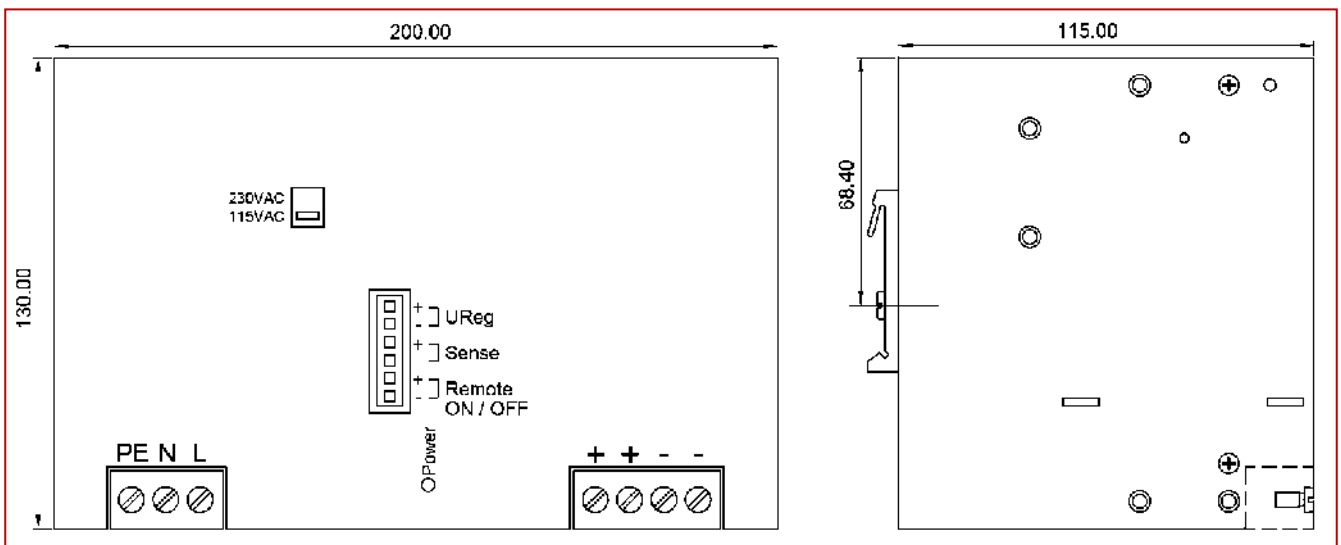

Mounting Instruction: recommended airflow space below and above is 50mm (2 Inch)

### Mechanics & Installation Instruction of the HSEUreg

Stable metal/aluminium housing IP20. To allow adequate convection, a free air space of 50mm (top/bottom) and 10mm (sidewalls) is required; and for active devices 15mm space from the sidewalls.

One can use the DIN-Rail installation (equipped standard) with our patented 35mm DIN-Rail bracket according to EN60715. It is easy to mount/dismount while snapping it onto the 35mm DIN-Rail - no tools necessary.

**It is not allowed to install the HSEUREG in other mounting direction then below drawings.**

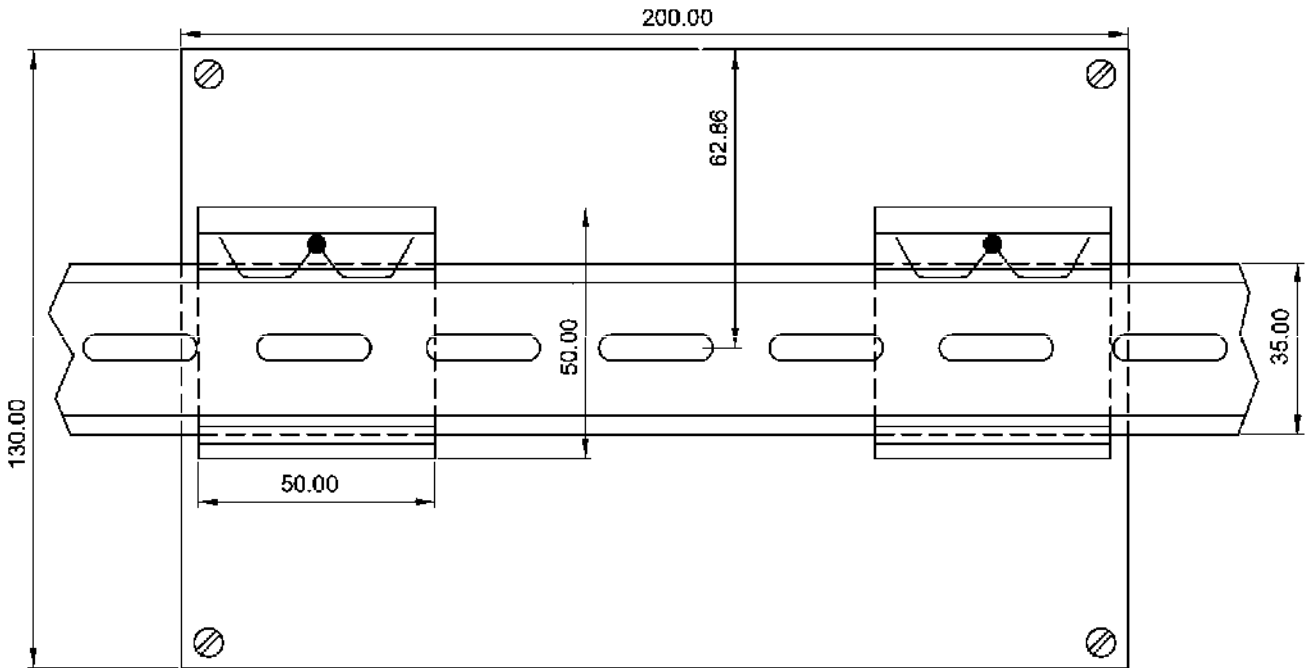

### Back Plate Option / DIN-Rail Standard

(The HSEUREG is always delivered for DIN-rail mount, the back-plate is an optional part that shall be mounted from the customer. The threads from the DIN-rail mounting brackets shall be used. All screws are included into the Back-Plate Kit.)

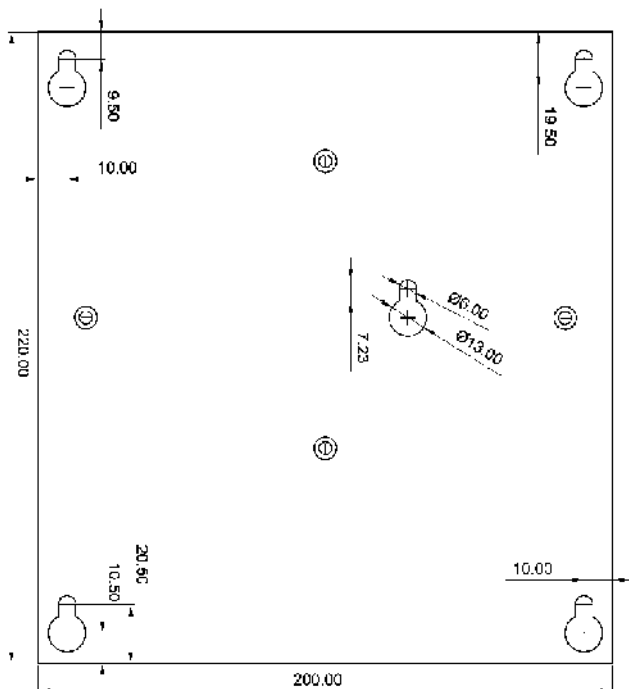



# Connections

## Clamping Yoke Connector Specifications

	Input / Output connections	Optional Signal connections plugs
Tightening torque min. – max.	1,2 – 2,2Nm (blade 1,0x5,5 DIN5264 )	0,4 – 0,5Nm (blade 0,6x3,5 PH1 PZ1)
Touch-safe protection acc. to DIN VDE 0470	IP20 plugged/ IP10 unplugged	Not applicable
Clamping range, min. – max.	0,5 – 16mm <sup>2</sup> / AWG26 – AWG6	0,2 – 4,0mm <sup>2</sup> / AWG26 – AWG12
Solid, H05(07) V-U min. – max.	0,5 – 16mm <sup>2</sup>	0,2 – 4,0mm <sup>2</sup>
Stranded, H05(07) V-U min. – max.	6 – 16mm <sup>2</sup>	Not applicable
Flexible, H05(07) V-U min. – max.	0,5 – 16mm <sup>2</sup>	0,2 – 4,0mm <sup>2</sup>
w. plastic collar ferrule, DIN 46228 pt 4 min. – max.	2,5 – 10mm <sup>2</sup>	0,2 – 2,5mm <sup>2</sup>
w. wire end ferrule, DIN 46228 pt 1, min. – max.	2,5 – 10mm <sup>2</sup>	0,2 – 4,0mm <sup>2</sup>
Plug gauge in accordance with EN 60999 a x b; ø	5,4 x 5,1mm; 5,3mm	2,8 x 2,4mm; 2,5mm
Pitch (P)	10,16mm	5,08mm

## Wire Stripping Length (fine wired)

Nominal Cross Section	Wire End Ferrule	Stripping Length	Wire End Ferrule	Stripping Length
0,25mm <sup>2</sup>	H0,25/5	5mm	H0,25/10 HBL	8mm
0,5mm <sup>2</sup>	H0,5/6	6mm	H0,5/12 OR	8mm
1,0mm <sup>2</sup>	H1,0/6	6mm	H1,0/12 GE	8mm
2,5mm <sup>2</sup>	H2,5/12	12mm	H2,5/19D BL	14mm
4,0mm <sup>2</sup>	H4,0/12	12mm	H4,0/20 GDR	14mm
6,0mm <sup>2</sup>	H6,0/20	12mm	H6,0/20 SW	14mm
10,0mm <sup>2</sup>	H10,0/12	12mm	H10,0/22 EB	15mm

The length of ferrules is to be chosen depending on the rated voltage. The outside diameter of the plastic collar should not be larger than the pitch (P)

# Ordering Information

## Ordering Codes

Product Code	Information	Article Number
HSEUREG07201.015(R2)	0-18Vdc	3041052001CA
HSEUREG07201.030(R2)	0-30Vdc	3041052002CA
HSEUREG07201.050(R2)	0-50Vdc	3041052003CA
HSEUREG07201.090(R2)	0-90Vdc	3041052004CA
HSEUREG07201.130(R2)	0-130Vdc	3041052005CA
HSEUREG07201.180(R2)	0-180Vdc	3041052006CA
Certificate Calibration	Separate works certificate manufacturer calibration of the power supply	-
Back Plate Kit	Hart mount plate kit including screws	2201002001CA
Optional Interface Connectors	Optional 2poles Clamping Yoke Connector 180° cabling (10pcs per pack)	3520037



**Safety regulations: Please read these instructions completely before using the equipment. Keep these instructions on to hand. The device may only be operated by trained specialist staff.**

**Installation:**

- 1) The device is designed for devices and systems that meet the standard requirements for hazardous voltages, power, and fire prevention.
- 2.) Installation and service only by trained specialists. The AC power must be switched off. The work is to be labelled; accidental reconnection of the system must be prevented.
- 3.) Opening the device, its modification, loosening bolts, or operation outside the specified herein specification or in an unsuitable environment, has the immediate loss of warranty to follow. We disclaim any responsibility for any resulting damage to persons or things.
- 4.) Note: The device must not be operated without an upstream circuit breaker (CB). We recommend the use of C-Type 16A for 230Vac or 25A for 115Vac. It is prohibited to use the unit without PE. It may be necessary upstream device has a power switch.

**Warning:**

**Non-compliance these warnings can result in fire and serious injury or death.**

1. Never operate device without PE connection.
2. Before connecting the device to the AC network, make wires free of voltage and ensure that it cannot accidentally switch on.
3. Allow neat and professional cabling.
4. Never open nor try to repair the unit. Inside are dangerous voltages that can cause electrical shock hazard.
5. Avoid metal pieces or other conductive material to fall into the item
6. Do not operate the device in damp or wet conditions
7. Do not operate the unit under EX-conditions



All parameters base on 15 minutes run-in @ full load / 25°C / 230Vac 50/60Hz, as otherwise stated.