



CE

Model Number

OMH-ML100-04

Mounting aid for ML100 series, Mounting bracket

Features

- Mounting bracket
- Simple and fast mounting

Dimensions

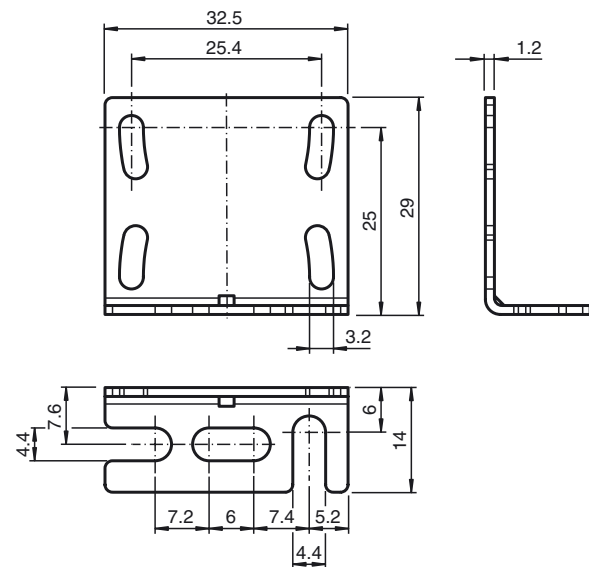

Technical data

Mechanical specifications

Material	Stainless steel
Mass	approx. 10 g
Mounting	Mounting accessories included

Suitable series

Series	ML100
--------	-------