

CLIPPER Industrial Plastic Connectors





FCI was created in 1989. The company is now the second largest connector manufacturer in the world and is the only European company amongst the first ten worldwide.

Its activities are geared towards 7 major markets: Communications, data, consumer, industrial & instrumentation, military and aerospace, energy and automotive.

FCI has its headquarters in Paris-France and employs more than 18,000 people in Europe, Asia and Americas.

With more than 60 production plants in 29 countries, FCI accounts for about 50% of the total sales of the Framatome Group within which FCI forms one of the two main activities.

**FCI
connects
the world**

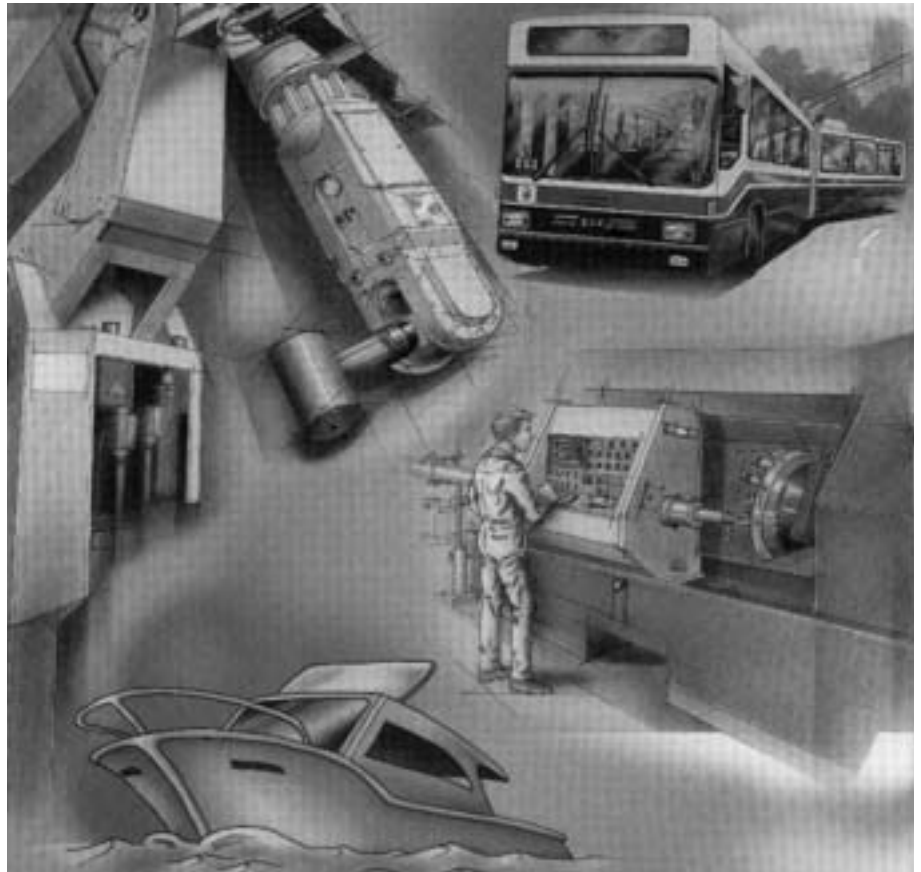

RU File No. 169916

SP File No. LR3934_C92

Table of Contents

Description/Features/Presentation	3
Square flange receptacle and in-line receptacle	4
Plug and backnut	5
Electrical thread backshell	6
Accessories	7
Stamped and formed contacts	8
Machined contacts	9
IP68 configurations	10
IP67 configurations	12
Mated and unmated connectors (with backshells) overall dimensions	15
Dimensions (receptacle and plug).....	16
Manual crimping tool	17
Automatic crimping tool.....	18
Panel mounting/panel cut-out	19
Wiring instruction	20
Assembly instruction.....	21
General technical information	23

Description

Retention plate principle

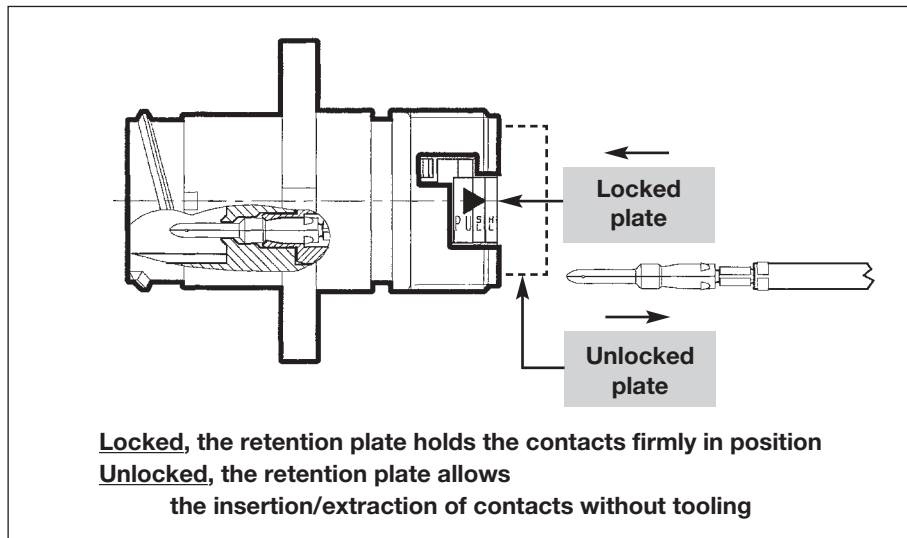

Features

Mechanical

- Monobloc shell and insulator in thermoplastic material self-extinguishing to UL 94 V0.
- 180° screw coupling with positive audible safety latch.
- Scoop proof.
- Copper alloy contacts, machined or stamped and formed
 - plating : gold on active part over nickel.
- Mechanical endurance :
 - connector : 250 cycles mating / unmating,
 - retention plate : 50 cycles mating / unmating.
- Retention force :
 - # 20 → 70 N
 - # 16 → 90 N.
- Vibration :
 - frequency range : 10-2000 Hz, 20 g
 - 10 cycles in accordance with CEI 68-2-6

Electrical

- Withstand voltage : 1500 Vrms min or in accordance with DIN 57110b.
- Contact resistance < 10 mΩ.
- Current rating per contact :
 - machined contacts : # 20 (7 Amps), # 16 (13 Amps)
 - stamped and formed contacts : # 20 (5 Amps), # 16 (10 Amps).

Environmental

- Sealing :
 - up to IP68
- Working temperature : -40°C to +125°C. (-40°F to +257°F)
- Resistance to salt spray :
 - 48 h min
 - > 1000 h (sealed mated connectors).
- Resistance to fluids :
 - oil,
 - petrol, fuel,
 - lubricants
 - other fluids : consult FCI.

Presentation



CLIPPER is a plastic low cost range of industrial connectors, UL & CSA approved.

Complementing FCI product range CLIPPER offers :

- a high sealing level :
 - IP67 for the sealed plug (with o'ring and mating seal)
 - IP68 for the enhanced sealed plug (with o'ring and a special mating seal).

This version allows a permanent waterproof level when immersed at depths down to 30 meters.









- a retention plate system allowing insertion/extraction of the contacts without the need for tooling,
- facilities to use trade backshells with the electrical thread adaptor (PG).

CLIPPER range is composed of :

- 4 sizes of shell in molded black thermoplastic material (size 1/2/3/4).
- 7 contact layouts (4/9/14/18/26/31/40 contacts).
- #20, #16 contacts, machined or stamped and formed, crimp, solder or PC tail termination.
- An adaptor with electrical PG thread for PG backshells.
- Backnut with grommet facilities.



Available Style Square flange receptacle and in-line receptacle

Contacts layouts		Part numbers								
		Unsealed receptacle (without o'ring)		Sealed receptacle (with o'ring) for use with backshell		Sealed receptacle (with o'ring and panel gasket)		In-line receptacle		
		for male contacts	for female contacts	for male contacts	for female contacts	for male contacts	for female contacts	unsealed for male contacts	sealed for male contacts	
Shell sizes	1	4 cts # 16 	CL1M1100	CL1R1100	CL1M1101	CL1R1101	CL1M1102	CL1R1102	CL1C1100	CL1C1101
		9 cts # 20 	CL1M1200		CL1M1201		CL1M1202		CL1C1200	CL1C1201
	2	9 cts # 16 	CL1M2100	CL1R2100	CL1M2101	CL1R2101	CL1M2102	CL1R2102	CL1C2100	CL1C2101
		14 cts # 20 	CL1M2200		CL1M2201		CL1M2202		CL1C2200	CL1C2201
	3	18 cts # 16 	CL1M3100	CL1R3100	CL1M3101	CL1R3101	CL1M3102	CL1R3102	CL1C3100	CL1C3101
		31 cts # 20 	CL1M3200		CL1M3201		CL1M3202		CL1C3200	CL1C3201
	4	26 cts # 16 	CL1M4100		CL1M4101		CL1M4102		CL1C4100	CL1C4101
		40 cts # 16 	CL1M4200	CL1R4200	CL1M4201	CL1R4201	CL1M4202	CL1R4202	CL1C4200	CL1C4201



Plug and backnut

Contact layouts		Part numbers								
		Unsealed plug (without o'ring and mating seal)		Sealed plug (with o'ring and mating seal)		Sealed backnut		Unsealed backnut		
		for male contacts	for female contacts	for male contacts	for female contacts	for male contacts	for female contacts	for male and female contacts		
Shell sizes	1	4 cts # 16		CL1P1100	CL1F1100	CL1P1101	CL1F1101 (IP67) CL1F1103 (IP68)	CL111102	CL111101	CL111000
		9 cts # 20			CL1F1200		CL1F1201 (IP67) CL1F1203 (IP68)	CL111202	CL111201	
	2	9 cts # 16		CL1P2100	CL1F2100	CL1P2101	CL1F2101 (IP67) CL1F2103 (IP68)	CL112102	CL112101	CL112000
		14 cts # 20			CL1F2200		CL1F2201 (IP67) CL1F2203 (IP68)			
	3	18 cts # 16		CL1P3100	CL1F3100	CL1P3101	CL1F3101 (IP67) CL1F3103 (IP68)	CL113102	CL113101	CL113000
		31 cts # 20			CL1F3200		CL1F3201 (IP67) CL1F3203 (IP68)	CL113202	CL113201	
	4	26 cts # 16			CL1F4100		CL1F4101 (IP67) CL1F4103 (IP68)	CL114102	CL114101	CL114000
		40 cts # 16		CL1P4200	CL1F4200	CL1P4201	CL1F4201 (IP67) CL1F4203 (IP68)	CL114202	CL114201	



Electrical thread backshells (PG)

Unsealed (IP40)

Type	Description	Part numbers				
		Shell sizes				
		1 (PG 13.5)	2 (PG 16)	3 (PG 21)	4 (PG 29)	4 (PG 36)
	Straight backshell for flexible conduit systems	CL101040	CL102040	CL103040	CL124040	CL104040
	Straight cable clamp	CL101030	CL102030	CL103030	CL124030	-

Sealed

	Elbow backshell with sealing gland	CL101051	CL102051	CL103051	CL124051	-
	Straight backshell for flexible conduit systems	CL101041	CL102041	CL103041	CL124041	CL104041
	Anti-decoupling sealing gland backshell	CL101021	CL102021	CL103021	CL124021	CL104021

Note : Electrical thread backshells are always supplied complete with the adaptor.

Accessories

Panel gasket (for square flange receptacle)

Shell sizes	1	2	3	4
Part numbers	CL191001	CL192001	CL193001	CL194001

PG threads adaptor for commercial backshell

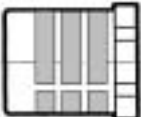
	CL101000	CL102000	CL103000	CL124000 (pg 29)
				CL104000 (pg 36)

90° adaptors for receptacles

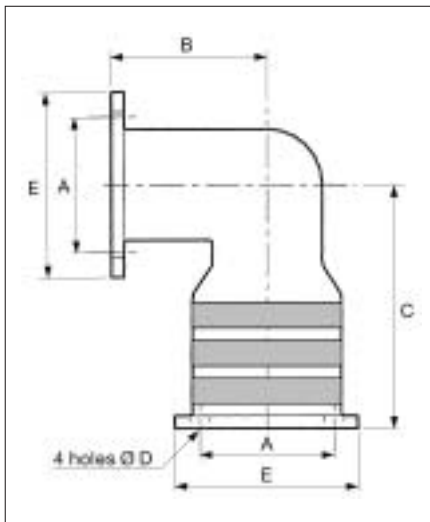

Dim. (inches)	Shell sizes				
	A	B	C	D	E
1	.84	.96	1.52	.13	1.15
2	.97	1.10	1.56	.13	1.21
3	1.12	1.20	1.69	.15	1.40
4	1.44	1.55	1.95	.15	1.87

90° sealed adaptors for receptacles Shell 1 to 4

Shell	Part numbers
	Sealed*
1	CL131001
2	CL132001
3	CL133001
4	CL134001

* with panel gasket

IP67 Dust cap for receptacle

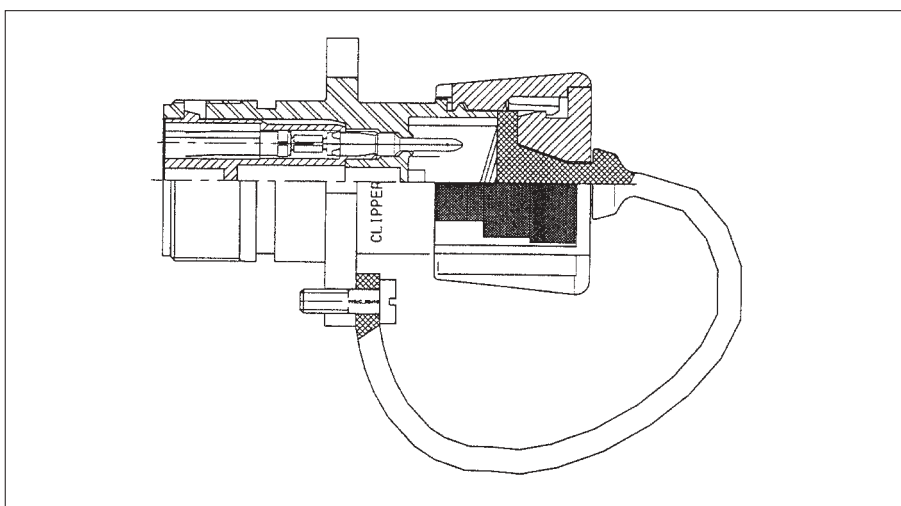

Shell	Part numbers
1	CL141001
2	CL142001
3	CL143001
4	CL144001

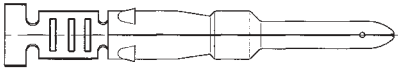
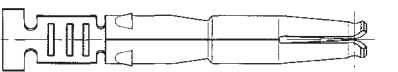
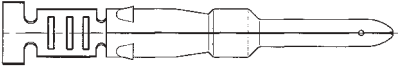
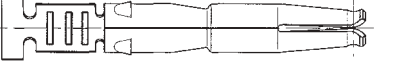
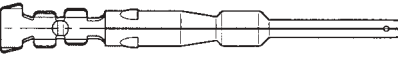
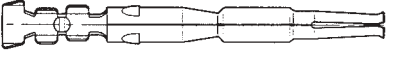
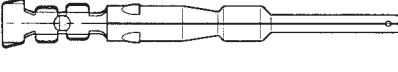
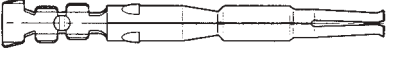

Stamped and formed contacts

Packaging	Crimp Contact with strain relief		Part numbers	Size	Ø mm over insulation (inches)	AWG	Admissible section mm ²
Bulk		male	CF16PC10RF	16	2 mm to 3 mm (0.08" to 0.12")	18 to 16	0.7 to 1.5 mm ²
		female	CF16SC10RF				
Reel 5,000 pcs.		male	CF16PC18RF				
		female	CF16SC18RF				
Bulk		male	CF10PC10RF	20	1.2 mm to 2.1 mm (0.05" to 0.08")	22 to 20	0.35 to 0.6 mm ²
		female	CF10SC10RF				
Reel 5,000 pcs.		male	CF10PC18RF				
		female	CF10SC18RF				

Plating RF : gold flash on active part for standard version (For other platings, consult FCI)

← Assembly

Filler plug # 16
(for un-used contact cavities)

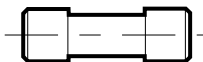

Part number : 8500 479 CL

Filler plug # 20
(for un-used contact cavities)





Part number : 8500 4144

Polarization Contact
(instruction for polarizing connector - see page 23)





Part number : CP16SW9700

Print Circuit (PC) Tail Machined Contact

Bulk		male	16			CM16PT10LY
		male	20			CM10PT10LY

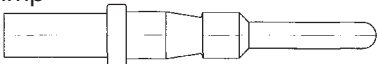
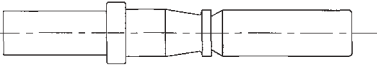

Machined contacts

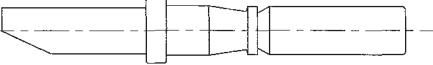
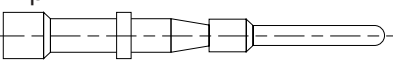
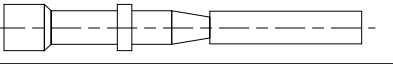
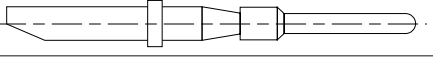
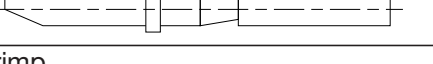
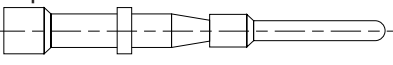
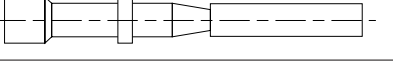
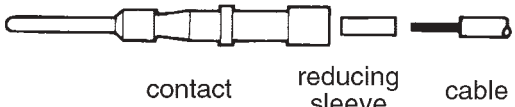
Packaging	Contact types		Part numbers	Size	Ø mm over insulation (inches)	A W G	Admissible section mm ²
	crimp 	male	CM16PC10MQ	16	2 mm to 3 mm (0.08" to 0.12")	18 to 14	0.93 to 1.91 mm ²
		female	CM16SC10MQ				
	solder 	male	CM16PS10MQ			14* Max	
		female	CM16SS10MQ				
Bulk	crimp 	male	CM10PC10MQ	20	1.2 mm to 2.1 mm (0.05" to 0.08")	24 to 18	0.21 to 0.93 mm ²
		female	CM10SC10MQ				
	solder 	male	CM10PS10MQ			18 Max	
		female	CM10SS10MQ				
	crimp 	male	CM16PC00MQ	16	2 mm to 3 mm (0.08" to 0.12")	18 to 13	0.93 to 2.60 mm ²
		female	CM16SC00MQ				
 contact reducing sleeve cable		male	CM16PC20MQ	16	2 to 3 mm (0.08" to 0.12")	20	0.21 to 0.60 mm ²
		female	CM16SC20MQ				
		male	CM10PC20MQ	20	1.2 to 2.1 mm (0.05" to 0.08")	30 to 24	0.06 to 0.21 mm ²
		female	CM10SC20MQ				

Plating MQ : 0.4µ mm gold on active part (.016µ inches)

* Up to 1.91 mm²

Extended ground contact-crimp (Length + .039 inch = +1 mm)

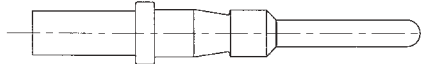
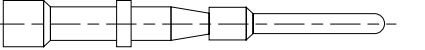
Bulk		male	16	0.08" to 0.12"	18 to 14	8501 9641
		male	20	0.05" to 0.08"	24 to 18	8501 9642 CL





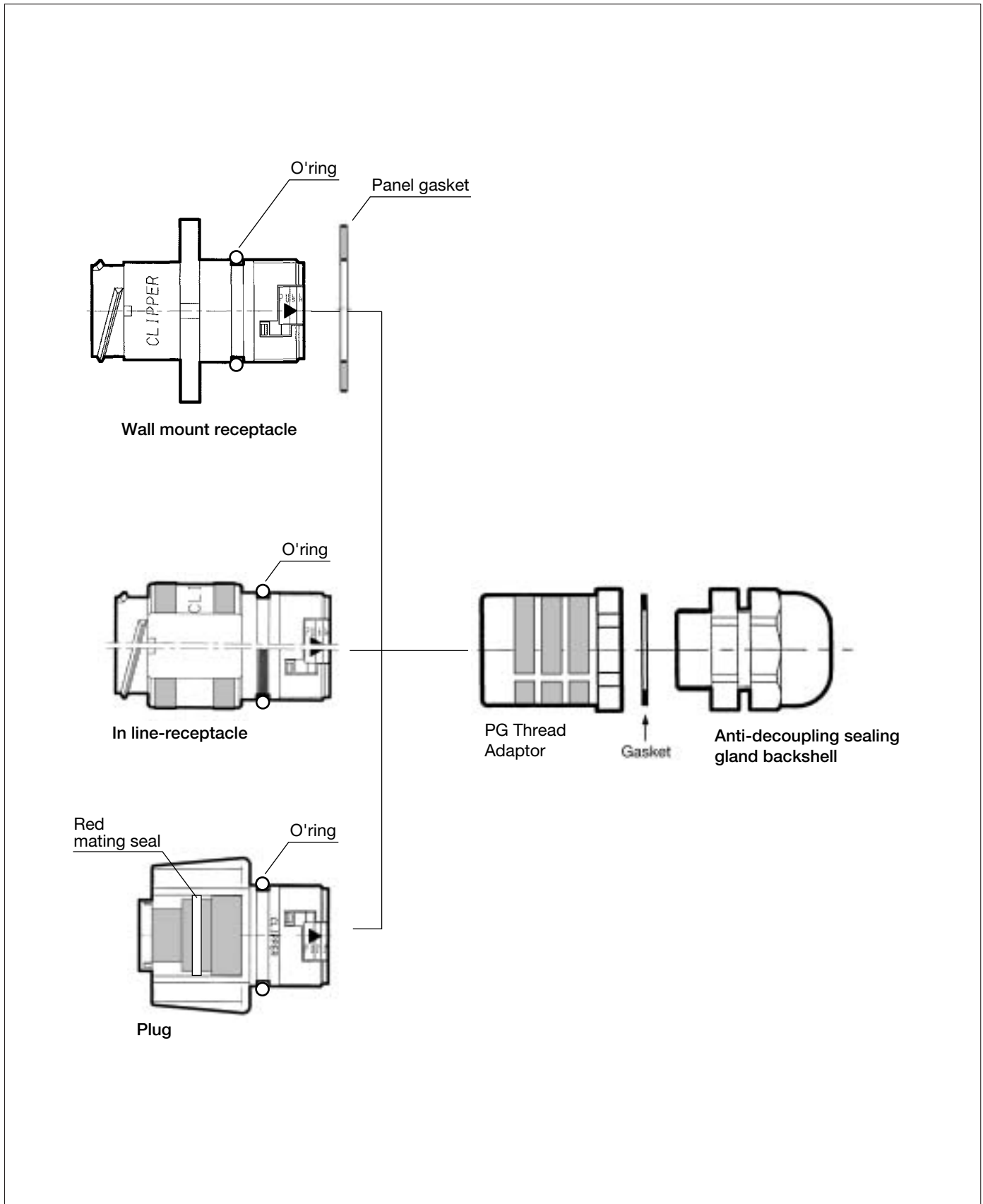

IP68 Configuration (temporary water tightness down to 100 feet)



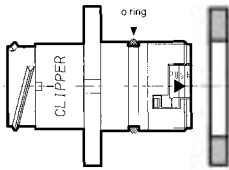
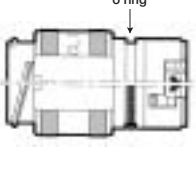
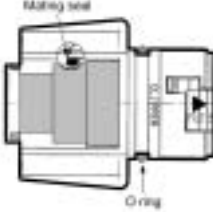
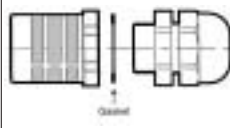

IP68 Configurations

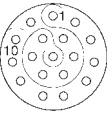
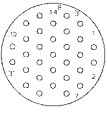
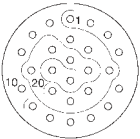
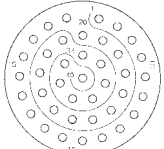
		Shell types (without contacts) and Backshell type	Part numbers			
			Sealed receptacle (with o'ring and panel gasket)	Sealed In-line receptacle	Sealed plug (with o'ring and mating seal)	Anti-decoupling sealing gland backshell
Shell sizes	1	4 cts # 16 				
		9 cts # 20 	CL1M1102	CL1C1101	CL1F1103	
	2	9 cts # 16 	CL1M1202	CL1C1201	CL1F1203	CL102021 (pg 16)
		14 cts # 20 	CL1M2102	CL1C2101	CL1F2103	
	3	18 cts # 16 	CL1M2202	CL1C2201	CL1F2203	CL103021 (pg 21)
		31 cts # 20 	CL1M3102	CL1C3101	CL1F3103	
	4	26 cts # 16 	CL1M3202	CL1C3201	CL1F3203	CL124021 (pg 29)
		40 cts # 16 	CL1M4102	CL1C4101	CL1F4103	
			CL1M4202	CL1C4201	CL1F4203	





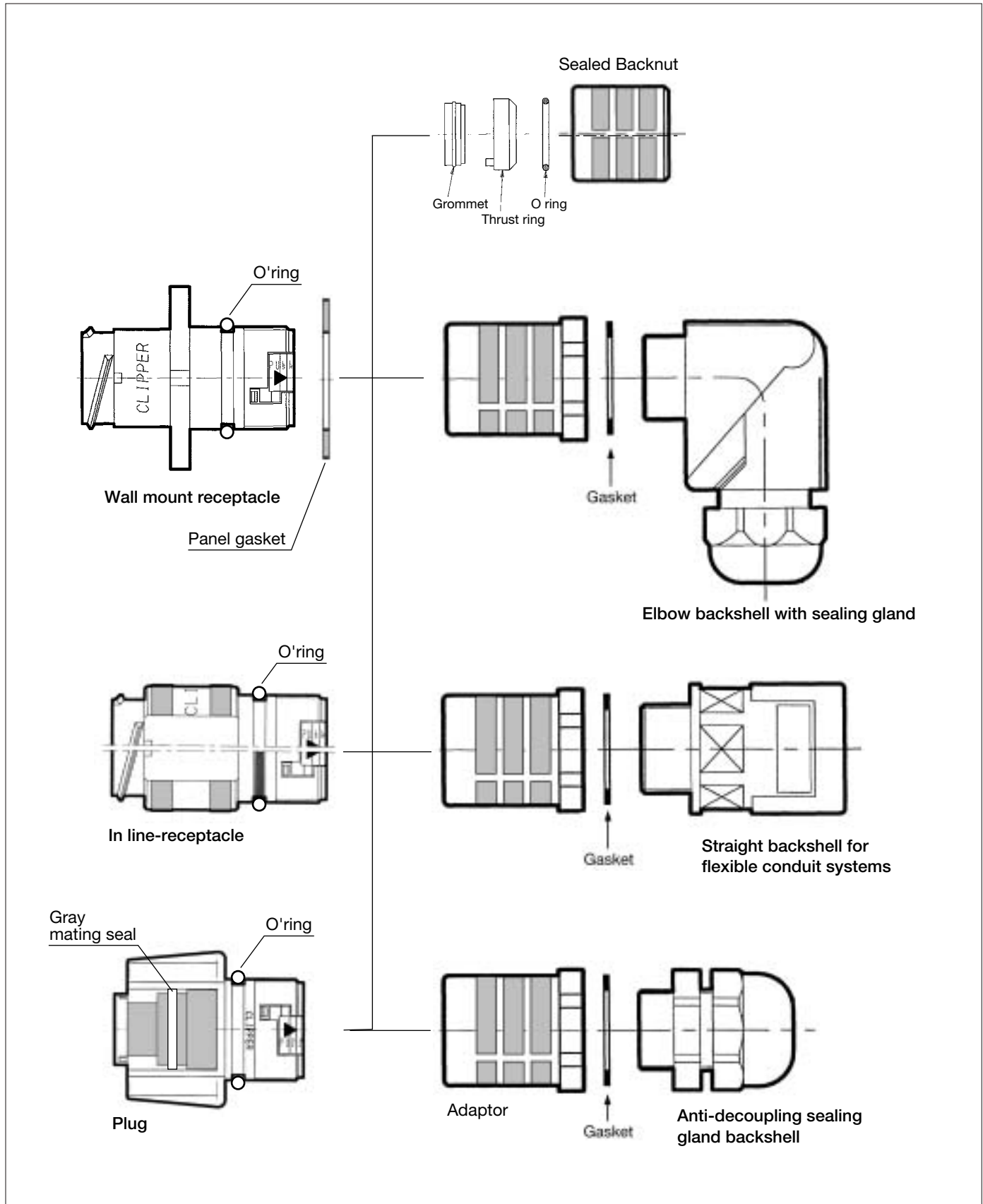





IP67 Configuration (temporary water tightness)













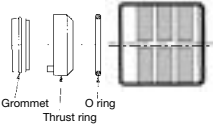
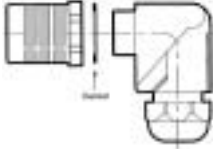

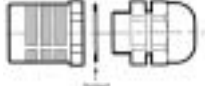
IP67 Configurations

		Shell types without contacts	Part numbers				
			Sealed receptacle (with o'ring and panel gasket)		Sealed plug (with o'ring and mating seal)		Sealed In-line receptacle
			for male contacts	for female contacts	for male contacts	for female contacts	for male contacts
Shell sizes	1	4 cts # 16 	CL1M1102	CL1R1102	CL1P1101	CL1F1101	CL1C1101
		9 cts # 20 	CL1M1202			CL1F1201	CL1C1201
	2	9 cts # 16 	CL1M2102	CL1R2102	CL1P2101	CL1F2101	CL1C2101
		14 cts # 20 	CL1M2202			CL1F2201	CL1C2201
	3	18 cts # 16 	CL1M3102	CL1R3102	CL1P3101	CL1F3101	CL1C3101
		31 cts # 20 	CL1M3202			CL1F3201	CL1C3201
	4	26 cts # 16 	CL1M4102			CL1F4101	CL1C4101
		40 cts # 16 	CL1M4202	CL1R4202	CL1P4201	CL1F4201	CL1C4201



IP67 Configurations

		Backshell types		Part numbers						
				Sealed backnut		Elbow backshell with sealing gland	Straight backshell for flexible conduit systems	Anti-decoupling sealing gland backshell		
				for male contacts	for female contacts					
Contact layouts										
Shell sizes	1	4 cts # 16		CL111102	CL111101	CL101051 (pg 13.5)	CL101041 (pg 13.5)	CL101021 (pg 13.5)		
		9 cts # 20		CL111202	CL111201					
	2	9 cts # 16		CL112102	CL112101	CL102051 (pg 16)	CL102041 (pg 16)	CL102021 (pg 16)		
		14 cts # 20								
	3	18 cts # 16		CL113102	CL113101	CL103051 (pg 21)	CL103041 (pg 21)	CL103021 (pg 21)		
		31 cts # 20		CL113202	CL113201					
	4	26 cts # 16		CL114102	CL114101	CL124051 (pg 29)	CL124041 (pg 29)	CL104041 (pg 36)	CL124021 (pg 29)	CL104021 (pg 36)
		40 cts # 16		CL114202	CL114201					



Mated and unmated connectors with backshells - Overall dimensions in inches

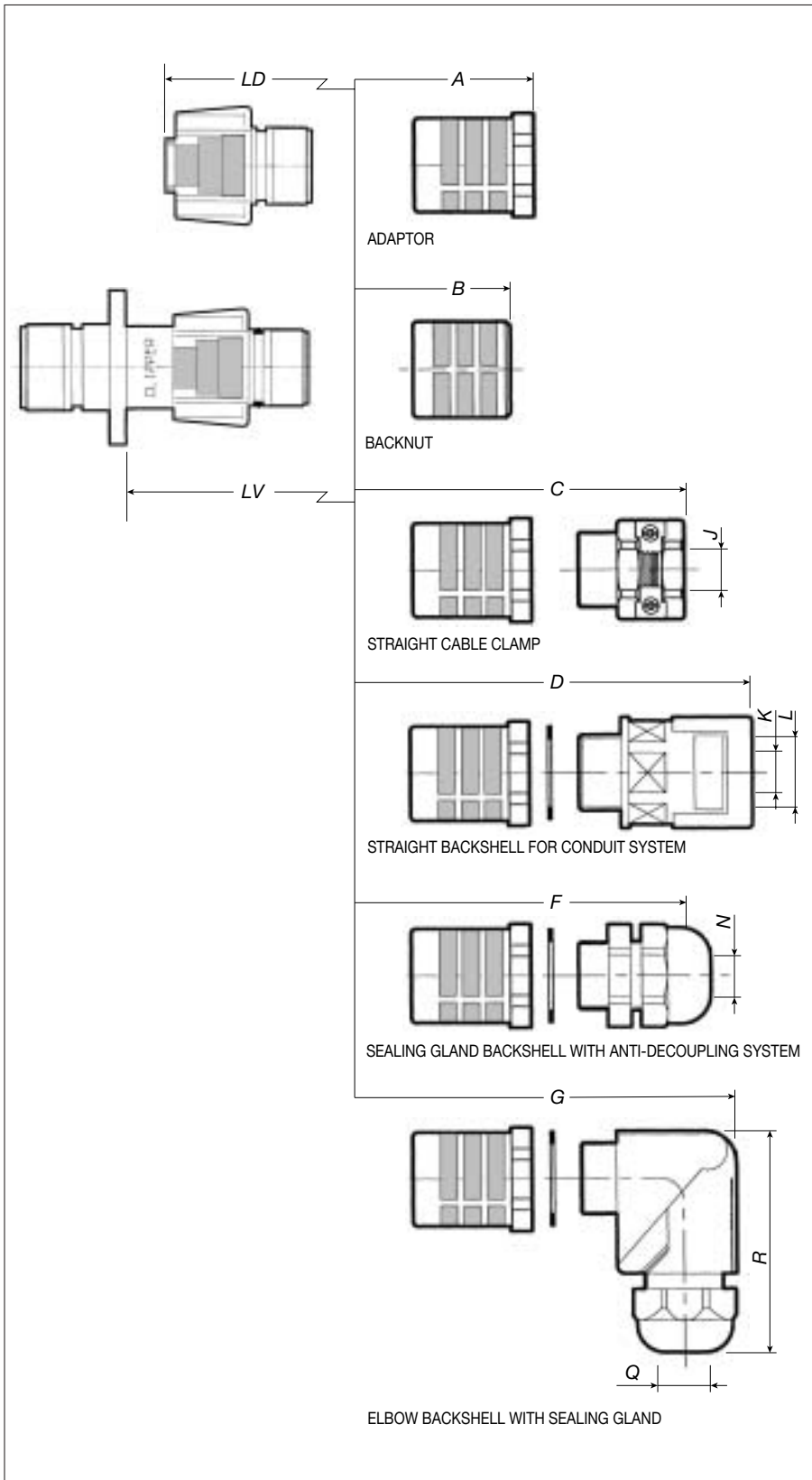

dimensions

Shell Dim. (inches)	1		2		3		4	
	1	2	3	4	(PG 29)	(PG 36)		
LDA	2.01	2.09	2.09	2.17	2.17			
LVA	2.29	2.33	2.33	2.41	2.41			
LDB	1.81	1.85	1.85	-	1.85			
LVB	2.09	2.09	2.09	-	2.09			
LDC	2.68	2.85	3.03	3.41	-			
LVC	2.97	3.09	3.27	3.60	-			
LDD	3.41	3.50	3.62	3.70	4.25			
LVD	3.70	3.74	3.86	3.94	4.47			
LDF	3.15	3.27	3.35	3.74	4.02			
LVF	3.43	3.50	3.58	3.98	4.25			
LDG	3.31	3.46	3.77	4.29	-			
LVG	3.58	3.70	4.01	4.52	-			
R Max.	2.24	2.34	2.87	3.58	-			

cable acceptance *

Shell Dim. (inches)	1		2		3		4	
	1	2	3	4	(PG 29)	(PG 36)		
J	.24/.55	.24/.63	.31/.83	.39/1.10	-			
Conduit L Pmaxflex	.67	.67	.91	1.14	1.42			
K Max.	.63	.63	.85	1.08	1.42			
N	.24/.47	.39/.55	.51/.71	.71/.98	.87/1.26			
Q	.24/.47	.39/.55	.51/.71	.71/.98	-			

* For other needs, consult FCI.



Dimensions in inches

Square flange receptacle

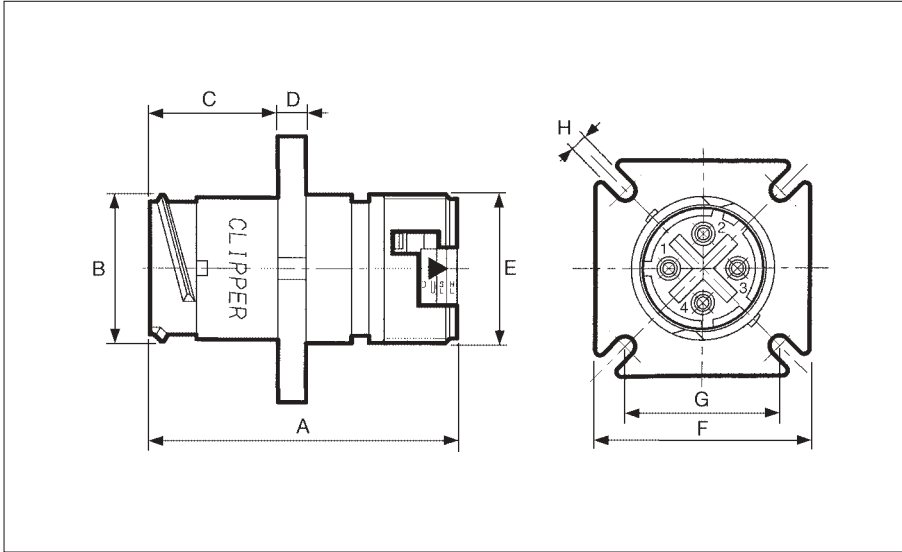

Dim. (inches)	Shell sizes	1	2	3	4
	A		1.67	1.67	1.67
B		.83	.96	1.14	1.59
C		.71	.71	.71	.71
D		.16	.16	.16	.16
E		.81	.94	1.12	1.57
F		1.17	1.23	1.42	1.89
G	min.	.83	.96	1.11	1.43
	Max.	.92	.98	1.17	1.57
H		.13	.13	.15	.15

Plug

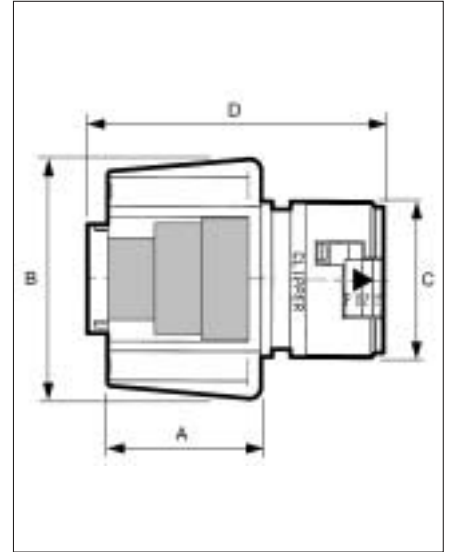

Dim. (inches)	Shell sizes	1	2	3	4
	A		.8	.8	.8
B		1.15	1.28	1.46	1.92
C		.81	.94	1.12	1.57
D		1.52	1.56	1.56	1.56

Manual Crimping Tool

Stamped and Formed Contacts (#16 and #20)

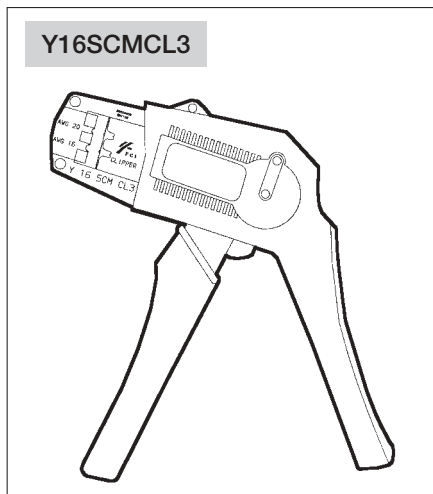

- Squeeze the plier handles until a final click sounds, release, the pliers should open by themselves.
- Fully insert the contact into the locator (corresponding gauge), the contact crimping lugs should be directed upwards, according to the drawing.
- Put the stripped wire in the crimping part until it comes in contact with the stopper plate. Make sure that no strands stick out of the crimping part.
- Squeeze the plier handles until a final click sounds, release, the pliers should open by themselves.
- Check the overall aspect of the crimping.

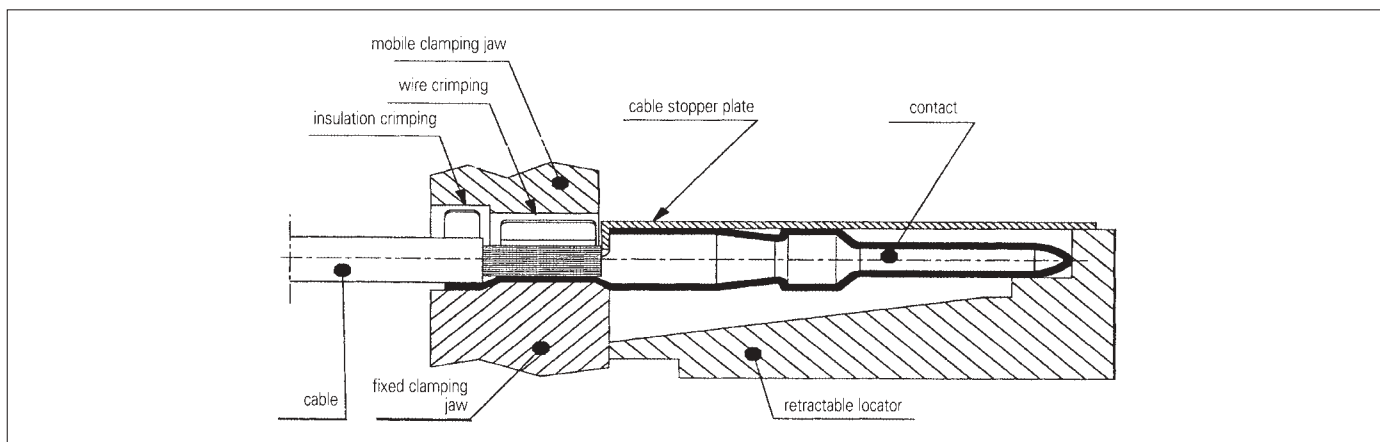

Machined Crimping Contacts (#16 and #20)

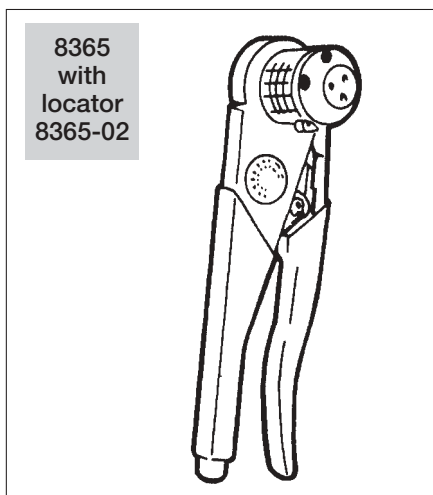

- Push the cable into the contact barrel and make sure the cable strands stick out of the inspection hole.
- The pliers must be used on the jaws side.
- Squeeze the plier handles until a final click sounds, release, the pliers should open by themselves.
- Insert both wire and contact (or wire, reducing sleeve and contact) between the 4 jaws until stopped by the locator.
- Fully squeeze until a final click sounds, the pliers should open once the crimping is performed
- Extract the wire and crimped contact, then check the overall aspect of the crimping.



UTM2 Automatic crimping tool for Clipper

Description

Electromechanical high speed semi automatic press is designed for mass production and is realized totally in assembled steel parts.

Voltage: 115VAC - 60 Hz
 Power.: 700 Watts
 Weight: 300 lbs. (including one crimp mechanism)
 Dimensions: 939.8x533.4x711.2 mm
 (37.0"x21.0"x28.0")



Crimping Mechanism (left side miniapplicators)

Contacts	AWG	Contact P/N	Crimp Mech. P/N
16	16-18	CF16 PS 18RF CF16 SC 18RF	CM30-R
20	20-22	CF10 PS 18RF CF10 SC 18RF	CM31-R

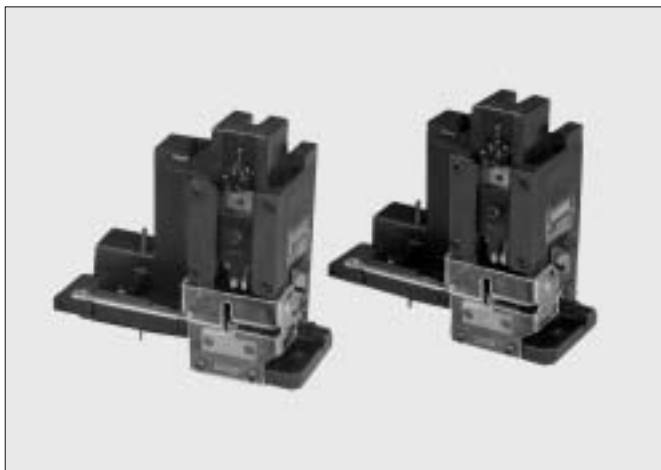

Press and crimping mechanism are rental. Please contact Customer Service.

Panel mounting

There are two types of mounting possible: through the front or through the back of the panel.

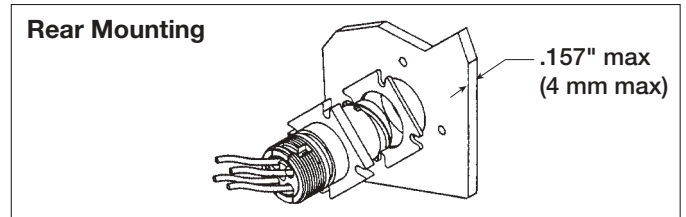
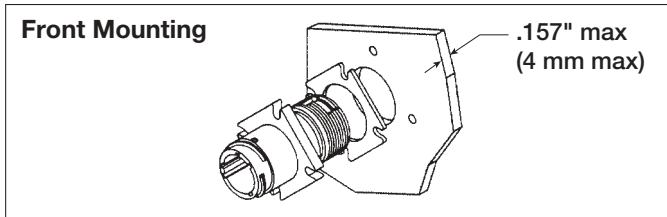

Panel cut-out

- For a sealed mounting, the seal gasket shall be used, making sure the surface is in good condition.
- Observe the drilling hole diameters indicated below.

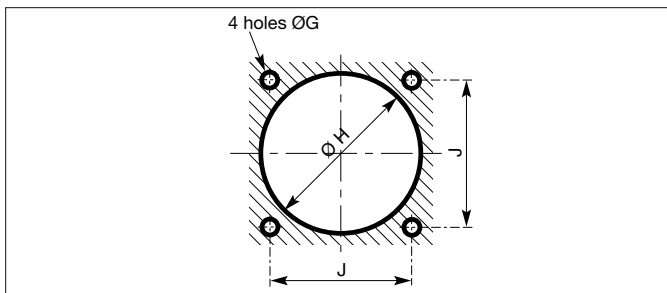

- Use the recommended screws :
M3 (all shells)
or # 4.40 (shells 1 and 2)
6.32 (shells 3 and 4)
- Respect the coupling torques indicated M3
(all shells) : 0.70 N.m MAX

Shell sizes	1	2	3	4
Dim. (inches)				
H	0.85	0.98	1.22	1.61
J	0.84	0.97	1.13	1.44
G	0.13	0.13	0.15	0.15



Wiring Instruction

Stripping Instructions

Use the upmost care with stripping operation :

- Use stripping pliers appropriate for the cable gauge and which are in perfect condition.
- In order to obtain a correct crimping and to maintain all of the connector sealing characteristics, the wires must have the dimensions described below.

Jacketed Cable Stripping Length

Make a 90° cut at the cable end.

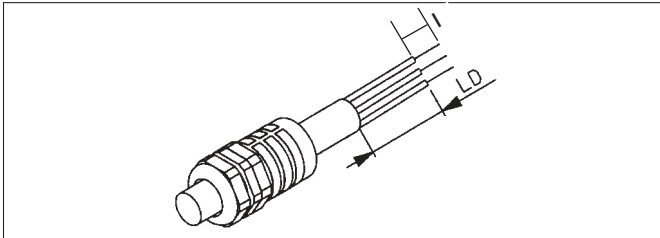

carefully make an incision in order to remove the cable protection on a length LD as described.

Shell size	1	2	3	4	
layouts	Indifferent			26	40
LD mm (inch)	60 (2.36")	65 (2.56")	65 (2.56")	80 (3.15")	100 (3.94")

Caution : This operation should be realized without deterioration of wires insulation.

Then, follow the normal stripping instructions :

- single wire with machined crimping contacts,
- single wire with stamped and formed crimping contacts

Wire Stripping Length

- With machined crimping contacts

Contact size	I = Wire stripping length
#16	6 mm (.236")
#20	\varnothing over insulation ≤ 2 mm \Rightarrow I = 5 ($\leq .08$ " \Rightarrow I = .20") \varnothing over insulation > 2 mm \Rightarrow I = 7 ($> .08$ " \Rightarrow I = .27")

- With stamped and formed crimping contacts

Contact diameter	I = Wire stripping length
#16	4 mm (.157")
#20	4 mm (.157")

Instruction For Assembly

Insertion and extraction of contacts

Single wires

Contact insertion and extraction is performed without a tool thanks to the retainer plate system.

Insertion

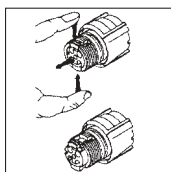

1) With the thumb and index finger, squeeze the retainer plate flaps and pull backwards : the plate is then in the unlocked position.

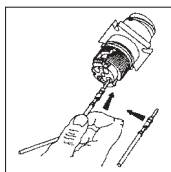

2) Fully insert the wired contact in the cavity.

3) Repeat the same procedure for the other contacts.

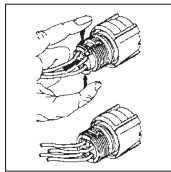

4) Once again squeeze the retainer plate flaps and push forwards: the plate is then locked and retains the contacts (90 N of retention force for contacts of 1.6 mm dia.)

5) The plate can only be pushed back if the contacts are correctly engaged (backup security)

Extraction

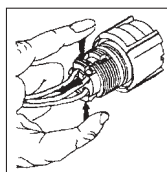

1) With the thumb and index finger, squeeze the retainer plate flaps and pull backwards : the plate is then in the unlocked position.

2) Pull the contact wire: the contact comes out of the cavity.

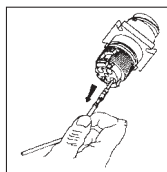

3) Repeat the same procedure for the other contacts.

Special case of jacketed cables

- 1) Locate the first contact and the corresponding cavity.
- 2) The wire should be described as a buckle as described below.
- 3) Unlock the retainer plate as described above.
- 4) Fully insert the wired contact in the cavity.
- 5) Respect the same procedure for the other contacts
- 6) Once again squeeze the retainer plate flaps and push forwards : the plate is then locked

- 7) Manually fully screw the adaptor and the backshell on the connector.

Caution : In the sealed version don't forget the O-ring.

- 8) Push forwards the cable of 10 mm in the backshell.
- 9) Fully screw on the backshell with a wrench while keeping the adaptor with another wrench.

Note : The plate can only be pushed back if the contacts are correctly engaged (backup- security)

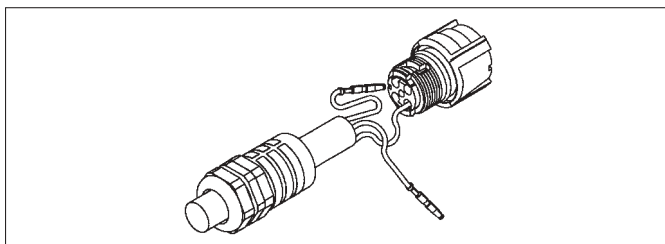



Instruction For Assembly

Adaptor and PG electrical thread backshells

The CLIPPER connector must be equipped with an adaptor in order to use a PG electrical thread backshell (e.g.: cable clamp or sealing gland, or flexible conduits system backshells, etc.)

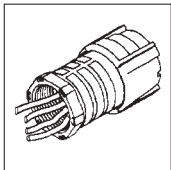

1) Manually, fully screw the adaptor on the connector, the hexagonal nut towards the rear.

2) In the sealed version, cover the O-ring.

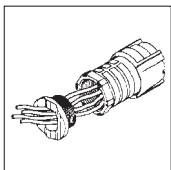

3) Manually, fully screw the PG thread backshell of your choice.

Note: In the case of an elbow backshell, it is possible to adjust the position according to the angle desired.

Grommet Backshell Assembly

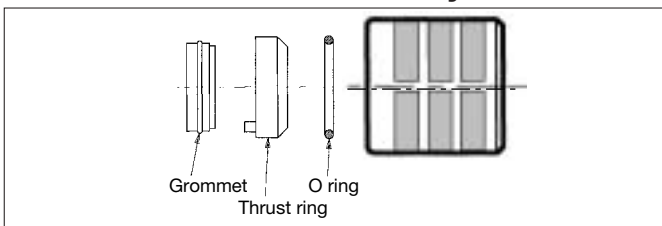

- 1) Position the O-ring at the bottom of the backnut.
- 2) Run the backnut around the cable.
- 3) Unlock the retainer plate.
- 4) Position the grommet in the thrust ring, resting against the retainer plate.
- 5) Insert the contacts through the grommet and the retainer plate.
- 6) Lock the retainer plate.
- 7) Screw the backshell.

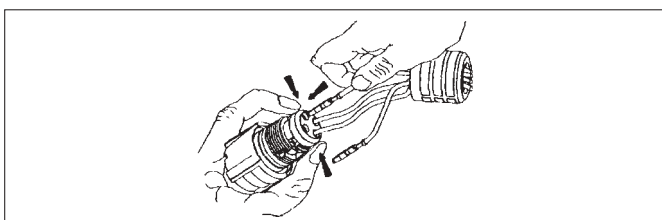

Heat shrink boot

Shrink sleeve as follows :

- 1) Use heat gun with an air deflector nozzle.
- 2) Adjust air deflector opening to accommodate tubing size. Turn switch ON. Wait until full heat output is reached.
- 3) Position the air deflector over section of tubing to be shrunk. Start at pre-shrunk section and work towards open end.
- 4) When tubing begins to shrink, move gun so that air is distributed in a band around the tubing circumference causing it to shrink evenly around the cable.
- 5) Move nozzle to adjacent section and shrink in the same manner. Repeat process on section at a time until entire length is shrunk.

Avoid excessive heat. Direct heat away from connector assembly to prevent damage.

Instruction for polarizing connector mounting

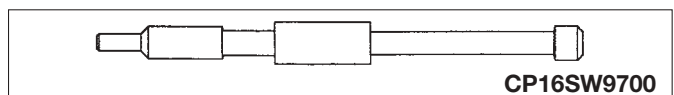

When the insert is partially filled with contacts, place polarization contact into selected hole location in the FEMALE INSERT and push in until seated.

- Polarization contacts are used to provide keying capabilities for the CLIPPER series.
- Polarization contacts are used in the **socket-cavities** of standard plugs and reverse receptacles.

In order to lock the couple of chosen connectors, you have to let free the cavity in front of the polarization contact.

To avoid the connection with other connectors, you have to insert a contact in the cavity in front of the polarization contact.



General technical information

Degree of protection in accordance with CEI 529, DIN 40050, NF EN 60529

First index Protection against accidental or inadvertent contact. Prot. against ingress of foreign bodies.		Second index Protection against ingress of water		Third index Protection against mechanical strength	
Index	Test	0 No protection	2 Protection against diagonal drop water drips (up to < of 15° of vertical)	0 No protection	
0	IP0 No protection	IPx0		Troisième chiffre	Test
1	IP1 Ball Ø2 inch Protection against contact with any large area by hand, protect. against large solid foreign bodies with Ø > 2 inch.	1 Protection against vertical drop water drips. IPx1	 ± 15°	1 Impact strength : 0,225 J 250 g 5,9 inch IPxx1	
2	IP2 Ball Ø .5 inch Test finger Protection against contact with the fingers, prot. against solid foreign bodies with Ø 0.5 inch	3 Protection against diagonal drop water drips (up to < of 60° out of vertical)	4 Protection against splash water from all directions	3 Impact strength : 0,5 J 250 g 7,8 inch IPxx3	
3	IP3 Steel wire Ø 0.1 inch Protection against tools wires or similar objects with Ø > 0.1 inch, prot. against small foreign solid bodies with Ø > 0.1 inch	5 Protection against water (out of a nozzle) from all directions		5 Impact strength : 2 J 500 g 15,7 inch IPxx5	
4	IP4 Steel wire Ø .04 inch Protection against tools wires or similar objects with Ø > .04 inch, prot. against small foreign solid bodies with Ø > .04 inch	6 Proof against temporary flooding		7 Impact strength : 6 J 1,5 kg 15,7 inch IPxx7	
5	IP5 IP6 Full protection against accid. or inadiv. contact. Prot. against interior injurious dust deposits. Talc	7 Protection against water plunging Proof against temporary water plunging IPx7	8 Water tight	9 Impact strength : 20 J 5 kg 15,7 inch IPxx9	
6	Total protection against acid. or inadiv. contact. Protection against of dust.		W Proof against water pressure		

EXAMPLE : IP66-5 means: - Total protection against dust
- Proof against temporary flooding
- Proof against impact strength of 2 Joule



Conversion Table

• Millimeters / Inches

(mm)	(inches)	(mm)	(inches)	(mm)	(inches)
0.1	0.00394	8.2	0.32308	38.0	1.49720
0.2	0.00788	8.4	0.33096	38.5	1.51690
0.3	0.01182	8.6	0.33884	39.0	1.53660
0.4	0.01576	8.8	0.34672	39.5	1.55630
0.5	0.01970	9.0	0.35460	40.0	1.57600
0.6	0.02364	9.2	0.36248	40.5	1.59570
0.7	0.02758	9.4	0.37036	41.0	1.61540
0.8	0.03152	9.6	0.37824	41.5	1.63510
0.9	0.03546	9.8	0.38612	42.0	1.65480
1.0	0.03940	10.0	0.39400	42.5	1.67450
1.1	0.04334	10.5	0.41370	43.0	1.69420
1.2	0.04728	11.0	0.43340	43.5	1.71390
1.3	0.05122	11.5	0.45310	44.0	1.73360
1.4	0.05516	12.0	0.47280	44.5	1.75330
1.5	0.05910	12.5	0.49250	45.0	1.77300
1.6	0.06304	13.0	0.51220	45.5	1.79270
1.7	0.06698	13.5	0.53190	46.0	1.81240
1.8	0.07092	14.0	0.55160	46.5	1.83210
1.9	0.07486	14.5	0.57130	47.0	1.85180
2.0	0.07880	15.0	0.59100	47.5	1.87150
2.1	0.08274	15.5	0.61070	48.0	1.89120
2.2	0.08668	16.0	0.63040	48.5	1.91090
2.3	0.09062	16.5	0.65010	49.0	1.93060
2.4	0.09456	17.0	0.66980	49.5	1.95030
2.5	0.09850	17.5	0.68950	50.0	1.97000
2.6	0.10244	18.0	0.70920	51.0	2.00940
2.7	0.10638	18.5	0.72890	52.0	2.04880
2.8	0.11032	19.0	0.74860	53.0	2.08820
2.9	0.11426	19.5	0.76830	54.0	2.12760
3.0	0.11820	20.0	0.78800	55.0	2.16700
3.1	0.12214	20.5	0.80770	56.0	2.20640
3.2	0.12608	21.0	0.82740	57.0	2.24580
3.3	0.13002	21.5	0.84710	58.0	2.28520
3.4	0.13396	22.0	0.86680	59.0	2.32460
3.5	0.13790	22.5	0.88650	60.0	2.36400
3.6	0.14184	23.0	0.90620	61.0	2.40340
3.7	0.14578	23.5	0.92590	62.0	2.44280
3.8	0.14972	24.0	0.94560	63.0	2.48220
3.9	0.15366	24.5	0.96530	64.0	2.52160
4.0	0.15760	25.0	0.98500	65.0	2.56100
4.1	0.16154	25.5	1.00470	66.0	2.60040
4.2	0.16548	26.0	1.02440	67.0	2.63980
4.3	0.16942	26.5	1.04410	68.0	2.67920
4.4	0.17336	27.0	1.06380	69.0	2.71860
4.5	0.17730	27.5	1.08350	70.0	2.75800
4.6	0.18124	28.0	1.10320	71.0	2.79740
4.7	0.18518	28.5	1.12290	72.0	2.83680
4.8	0.18912	29.0	1.14260	73.0	2.87620
4.9	0.19306	29.5	1.16230	74.0	2.91560
5.0	0.19700	30.0	1.18200	75.0	2.95500
5.2	0.20488	30.5	1.20170	80.0	3.15200
5.4	0.21276	31.0	1.22140	85.0	3.34900
5.6	0.22064	31.5	1.24110	90.0	3.54600
5.8	0.22852	32.0	1.26080	100.0	3.94000
6.0	0.23640	32.5	1.28050	200.0	7.88000
6.2	0.24428	33.0	1.30020	400.0	15.76000
6.4	0.25216	33.5	1.31990	600.0	23.64000
6.6	0.26004	34.0	1.33960	800.0	31.52000
6.8	0.26792	34.5	1.35930	1000.0	39.40000
7.0	0.27580	35.0	1.37900	1200.0	47.28000
7.2	0.28368	35.5	1.39870	1600.0	63.04000
7.4	0.29156	36.0	1.41840	2000.0	78.80000
7.6	0.29944	36.5	1.43810	3200.0	126.08000
7.8	0.30732	37.0	1.45780		
8.0	0.31520	37.5	1.47750		

• °C/°F

(°C)	(°F)
-70	-94
-65	-85
-55	-67
-50	-58
-40	-40
0	32
37	98.6
80	176
125	257
150	302
170	338
200	392
250	482

• Pressure conversion

bar	psi	mmHg (torr)
10	145.0	7600
5	72.5	3800
2	29.0	1520
1	14.5	760
0.5	7.2	380
0.1	1.4	76

mbar	psi	torr (mmHg)
100	1.4	76
50	0.72	38
10	0.14	7.6
1.32	0.019	1



Notes:



Notes:



Notes:

U.S.A. Tel.: (800) 237-2374; 717-938-7200

Canada Tel.: 905-826-9810

Europe Tel.: 33-1-39-49-21-83

Asia/Pacific Tel.: 65-549-6666

