



MiniFlex® SERIES

Making use of the principle of Rogowski coils, the MiniFlex® models are flexible sensors offering a wide dynamic range for measuring AC currents and viewing high-speed current pulses.

The sensor's output voltage is proportional to the derivative of the current measured in the conductor and requires an electronic system for formatting.

The absence of a magnetic core at the centre of the coil brings several advantages:

- flexibility and light weight
- excellent response to rapid current changes, as it is not possible for induced Fourier currents to occur, so they do not increase the sensor's response time.
- excellent linearity due to the absence of core saturation even when there are very high current, as in the case of electric power transmission, electrical welding or applications involving high-power pulses.

The great care taken when manufacturing our sensors means they benefit from particularly homogeneous winding, with equidistant turns along the whole length of the sensor, thus ensuring good immunity against electromagnetic interference.

The MiniFlex® models are made up of a flexible sensor connected to a casing containing processing electronics which outputs a voltage with the same amplitude and form as the current measured.

• MiniFlex® MA110 series:

With their small diameter and size, the sensors in the MA110 series are ideal for measuring currents in the electrical cabinets of residential or tertiary buildings or in low-power cabinets in industry. The rugged click-together system benefits from IP67 ingress protection.

Available with "banana" or "BNC" connection technology, the MA110 series can be connected directly to a multimeter, a wattmeter or a logger for RMS measurements at the standard industrial frequencies. The casing offers 4 measurement calibres.

• MiniFlex® MA130:

The MA130 sensor, part of the same series as the MA110, can be used to measure currents on three-phase installations. It is equipped with BNC connections with adapters for banana plugs. The processing unit offers 3 measurement calibres. The rugged click-together system has IP67 ingress protection. It can be connected to the AC voltage inputs (mV AC, AC) of any power analyser, logger or other measuring instrument.

• MiniFlex® MA200 series:

The MA200 series is a family of "high-frequency" sensors specially designed for viewing and measuring electrical or electrotechnical signals with wide variations and high amplitude. These "insulated current probes for oscilloscopes" offer a bandwidth of 1 MHz and can be used to analyse currents with complex forms, transients present in electronic power supplies, welding units, etc.

MA110 - MA130 SERIES

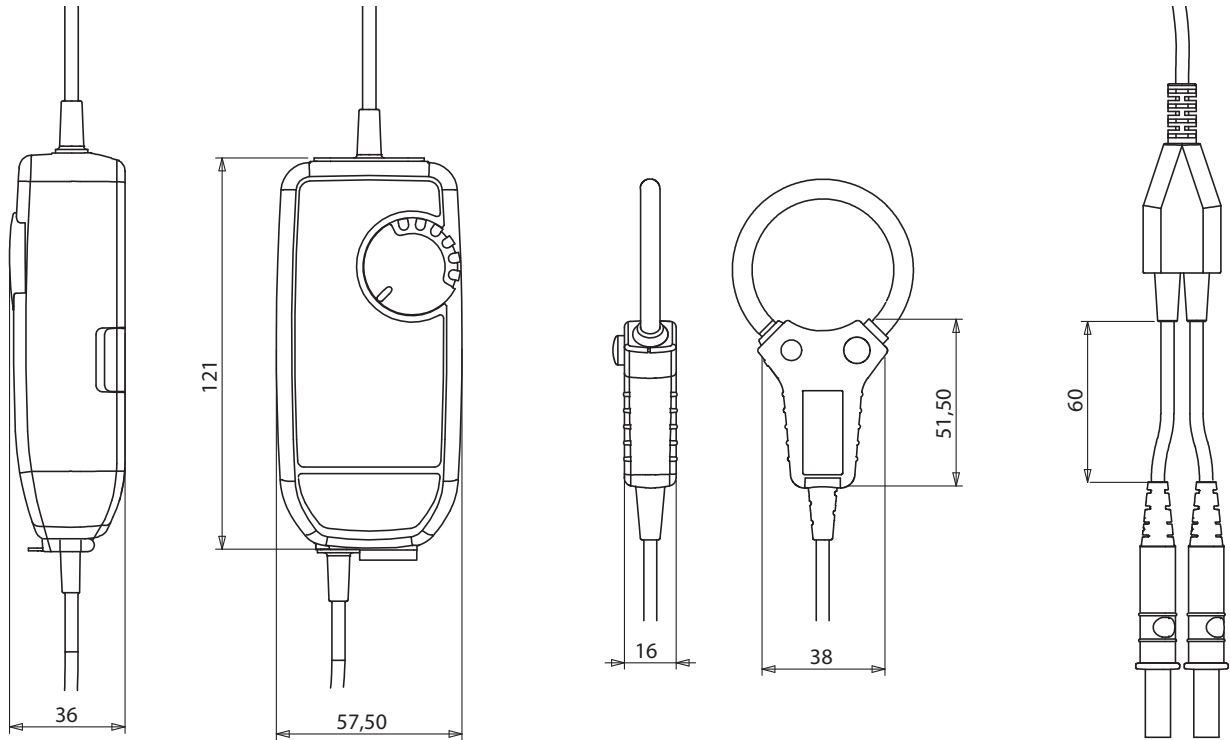

MA200 SERIES

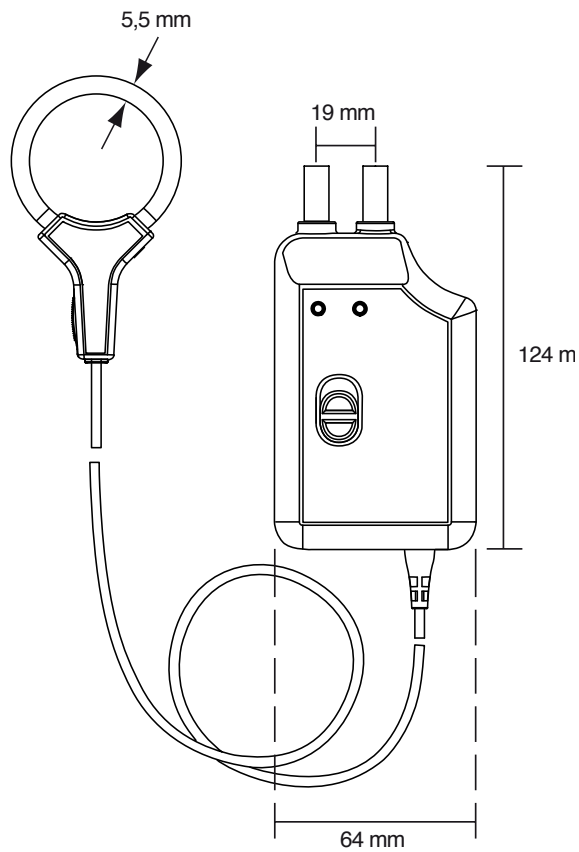

Flexible probe for AC current

Model MA110 3-30-3000-3000/3

MiniFlex® series

Current	3 A AC	30 A AC	300 A AC	3,000 A AC
Output	1 mV/mA	100 mV/A	10 mV/A	1 mV/A

DESCRIPTION

The model MA110 MiniFlex® sensor is a flexible sensor comprising an active part (Rogowski coil) linked to a casing containing electronics.

Unlike a current clamp with magnetic circuits, the MiniFlex® models are flexible and are not subject to magnetic saturation constraints, so they offer excellent linearity, low phase shift and a large dynamic range for measurement (up to several kA) while remaining easy to use. The sensors' flexibility makes it simple to clamp and measure any conductor, whatever its type (cable, busbar, strand, etc. and accessibility). The click-lock system for opening and closing the coil is specially designed for use with safety gloves.

The MA110 MiniFlex® sensor can be connected to the AC voltage input of any multimeter with Ø 4 mm female plugs.

The MiniFlex® MA110 model can be powered by batteries or by a standard external power supply. If the power supply fails, the instrument's batteries take over.

To maximize the battery life, the MiniFlex® MA110 model has an automatic standby system which can be deactivated at start-up to perform long-term measurement campaigns.

The MiniFlex® MA110 model has 3 green, yellow and red LEDs indicating, respectively, the power supply status, the status of the automatic standby function and any overruns of the measurement capacity.



SPECIFICATIONS FOR CURRENT MEASUREMENT ⁽¹⁾

Calibre (I _N)	3 A	30 A	300 A	3000 A
Measurement range in use	0.08 .. 3 A AC	0.5 .. 30 A AC	0.5 .. 300 A AC	0.5 .. 3000 A AC
Specified measurement range	0.5 .. 3 A AC	5 .. 30 A AC	5 .. 300 A AC	50 .. 3000 A AC
Output/input ratio	1 V/A (1 mV / mA)	100 mV / A	10 mV / A	1 mV / A
Bandwidth at -3 dB	10 Hz .. 10 kHz	10 Hz .. 20 kHz	10 Hz .. 20 kHz	10 Hz .. 20 kHz
Frequency limitation	Null	Null	Null	See curve
Intrinsic uncertainty	≤ 1 % + 40 mV	≤ 1 % + 4 mV	≤ 1.5 % + 0.4 mV (I < 10 % I _N) ≤ 1 % + 0.4 mV (I ≥ 10 % I _N)	≤ 1.5 % + 0.04 mV (I < 10 % I _N) ≤ 1 % + 0.04 mV (I ≥ 10 % I _N)
Phase shift at 50 Hz	≤ 1° (0.5° typical)	≤ 1° (0.5° typical)	≤ 1° (0.5° typical)	≤ 1° (0.5° typical)

ELECTRICAL SPECIFICATIONS ⁽¹⁾

- Operating voltage:**
 600 V_{RMS} (Cat. IV)
 1,000 V_{RMS} (Cat. III)
- Battery:**
 Two 1.5 V batteries (NEDA 15A, IEC LR6, AA)
 +5 VDC with a type B micro-USB connector
- Battery life ⁽²⁾:**
 300 hours typical
 1,800 10-minute approx. measurements
- Consumption:**
 10 µA (OFF position)
 90 µA (sleep mode)
- Battery level indication:**
 Flashing green LED (batteries voltage > 2 V)
- Influence of battery voltage:**
 ≤ 0.1 % (0.02 % typical) from 3.1 V to 2 V
- Influence of temperature:**
 ≤ 0.5 % (0.15 % typical) of output signal per 10 °K
- Influence of relative humidity:**
 ≤ 0.5 % (0.2 % typical) of output signal
- Influence of conductor position in the sensor ⁽³⁾:**
 ≤ 2.5 % (1 % typical)
- Influence of sensor deformation ⁽⁴⁾:**
 ≤ 1 % (0.2 % typical)
- Influence of adjacent conductor ⁽⁵⁾:**
 ≤ I_{ADJ} × 1 % (2 % near click-lock system)
 (0.2 % typical)
- Input impedance of the measuring instrument:**
 ≥ 1 MΩ
- Common mode rejection ⁽⁶⁾:**
 ≤ 80 dB (100 dB typical)
- Influence of the measurement instrument's impedance Z:**
 ≤ 0.1 % at 10 kΩ

Flexible probe for AC current

Model MA110 3-30-3000-3000/3

MiniFlex® series

MECHANICAL SPECIFICATIONS ⁽¹⁾

- Clamping capacity:**
 Model 170 mm: Ø max 45 mm
 Model 250 mm: Ø max 70 mm
 Model 350 mm: Ø max 100 mm
- Bending radius:**
 ≥ 20 mm
- Operating temperature:**
 -10 °C to +55 °C
- Storage temperature:**
 -40 °C to +70 °C
- Max. temperature of clamped conductor (measured):**
 90 °C for 10 minutes max.
- Relative humidity for operation:**
 0 to 85 % RH with a linear decrease above 35 °C
- Operating altitude:**
 0 to 2,000 m
- Casing protection rating (leakproofing):**
 Casing: IP54
 Sensor: IP 67
 According to IEC 60529 Ed. 2.2-2013
- Drop test:**
 1 m
- Self-extinguishing capability:**
 Casing: UL94-V2
 Sensor: UL94 V0
- Dimensions:**
 Casing: 120 x 55 x 39 (overall)
 Length of intermediate cable linking the sensor/ processing unit: 2 m
 Length of output cable: 0.5 m
 Ø of sensor: 6 mm
 Connection cable Ø: 4 mm
- Weight:**
 Model 170 mm: 300 g
 Sensor: 5 g / 10 cm
- Colours:**
 Sensor: red
 Sensor closing system: dark grey
 Casing: dark grey
- Output:**
 Two-wire cable with reinforced or double insulation terminated by 2 red and black isolated male banana plugs Ø 4 mm

SAFETY SPECIFICATIONS

- Electrical safety:**
 Class II equipment with double or reinforced insulation between the primary and the secondary (winding connected to the connection cable) as per EN 61010-1 and 61010-2-032:
Sensor:
 - Type B
 - 600 V Cat. IV / 1,000 V Cat. III, pollution degree 2
Casing:
 - 600 V Cat. IV between the terminals and the external enclosure of the casing
- Electromagnetic compatibility (EMC):**
 Complies with the industrial environments according to EN 61326-1 Ed. 02-2012:
 - Immunity to radiated fields: at 3 V/m, error ≤ 5% of measuring range (criterion A)

3,000 A calibre

Frequency limitation according to amplitude

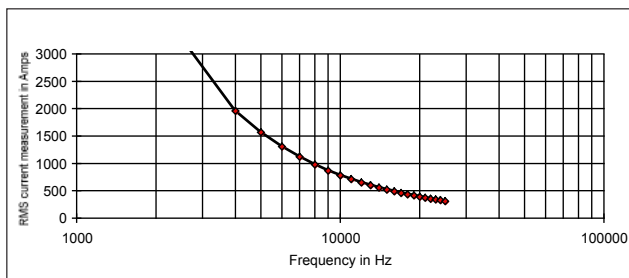

- (1) Conditions of reference: 23 °C ± 5 °K, 20 % to 75 % RH
 Battery voltage 3.2 V ± 0.1 VDC
 Frequency and form of signal measured: 30 to 440 Hz sinusoidal
 Continuous magnetic field < 40 A/m
 Absence of external AC magnetic field
 Absence of external electrical field
 Measured conductor centred in the circular sensor (coil) after operation for 1 minute
 Measurement instrument input impedance ≥ 1 MΩ
- (2) With 3,000 mA/h batteries, for a supplied voltage between 3.2 V and 1.8 V (1.6 V to 0.9 V per battery), giving an average voltage of 2.8 V
- (3) Whatever the conductor's position within the loop, as long as the sensor is not distorted (circular sensor)
- (4) Oblong shape
- (5) Adjacent conductor carrying an AC current I_{adj} , in contact with the sensor
- (6) For a 600 V voltage applied between the enclosure and the secondary

To order	Reference
MiniFlex® MA110 3-30-300-3,000 A / 3 V , length 170 mm , Output via cable terminated by 2 x Ø 4 mm isolated male banana plugs	P01120660
MiniFlex® MA110 3-30-300-3,000 A / 3 V , length 250 mm , Output via cable terminated by 2 x Ø 4 mm isolated male banana plugs	P01120661
MiniFlex® MA110 3-30-300-3,000 A / 3 V , length 350 mm , Output via cable terminated by 2 x Ø 4 mm isolated male banana plugs	P01120662

Flexible probe for AC current

Model MA110 3-30-3000-3000/3

MiniFlex® series



FREQUENCY RESPONSE

Calibre 3 A

Typical error on measurement according to frequency for a current of 2 A

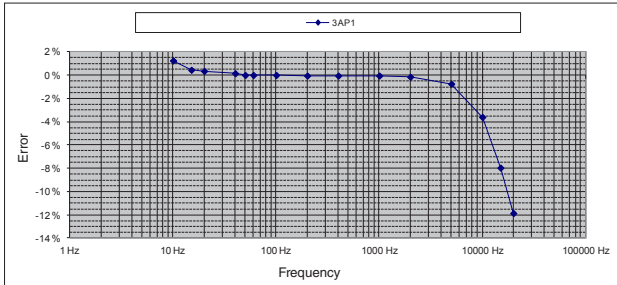

30 A calibre

Typical error on measurement according to frequency for a current of 20 A

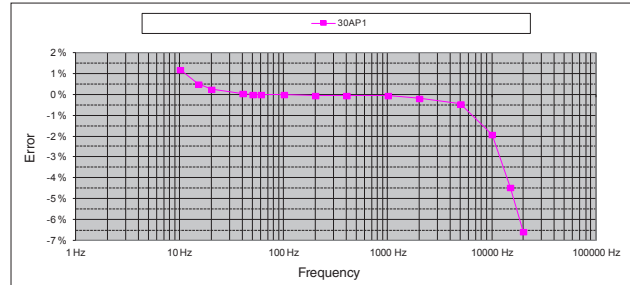

Typical phase shift according to frequency for a current of 2 A

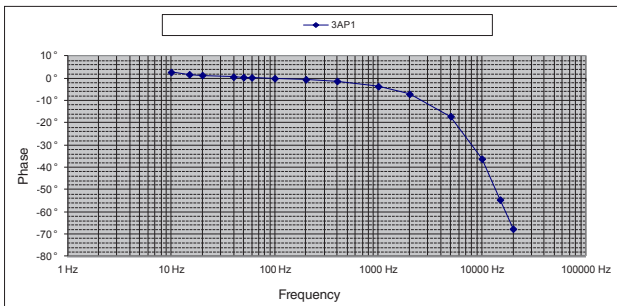

Typical phase shift according to frequency for a current of 20 A

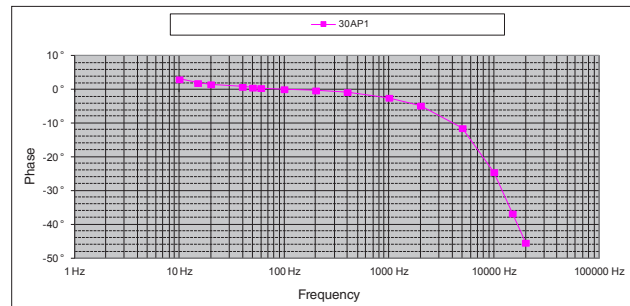

300 A calibre

Typical error on measurement according to frequency for a current of 20 A

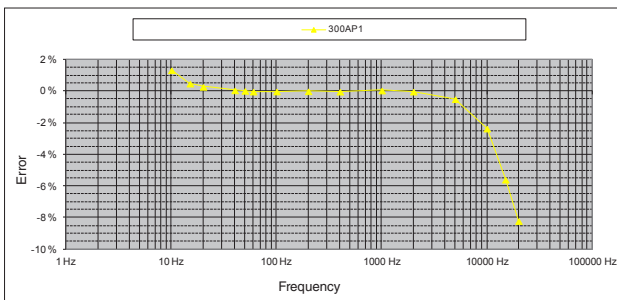

3,000 A calibre

Typical error on measurement according to frequency for a current of 20 A

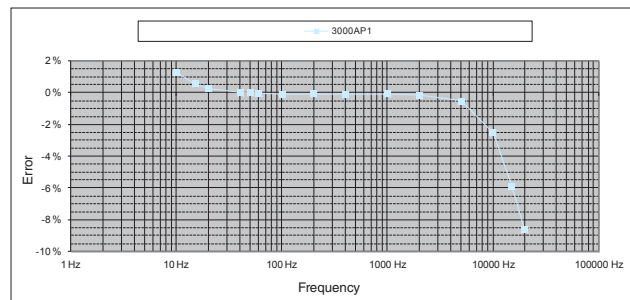

Typical phase shift according to frequency for a current of 20 A

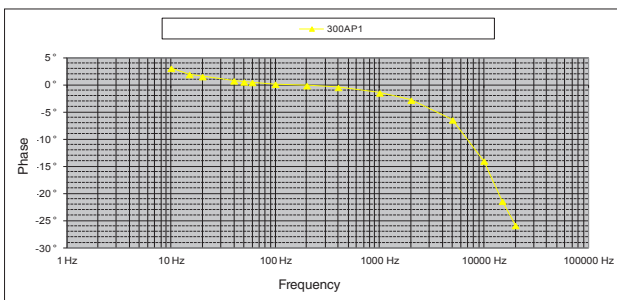

Typical phase shift according to frequency for a current of 20 A

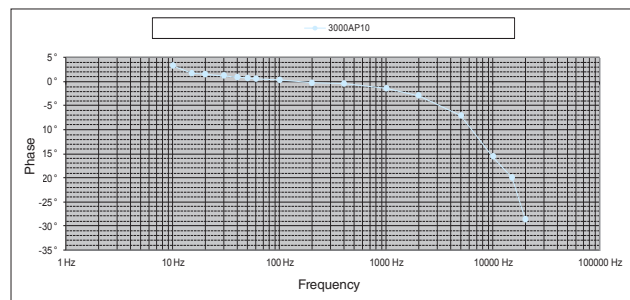

Flexible probe for AC current

Model MA110 on request

MiniFlex® series



CONFIGURATIONS

Level 1

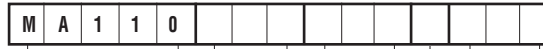

1 Category

2 Lead length in centimeters

Min value : **015** (15 cm)
 Max value : **100** (100 cm = 1 m)

Increment per 5 cm section

3 Length of connection lead in centimeters

Min value : **050** (50 cm)
 Max value : **995** (9.95 m)

Increment per 5 cm section

4 Output via

A: coaxial cable of the length to be defined in 5 terminated by a 600 V CAT III isolated male BNC socket

B: cable 50 cm long terminated by 2 red/black Ø 4 mm isolated male banana plugs rated 600 V CAT IV

C: shielded cable with 2 bared, tin-plated conductors of the length to be defined in 5, rated 600 V CAT IV

5 Output cable length in cm

If 4 = "A"

Min value : **050** (50 cm)
 Max value : **110** (1.10 m)

Increment per 5 cm section

If 4 = "C"

Min value : **050** (50 cm)
 Max value : **995** (9.95 m)

Increment per 5 cm section

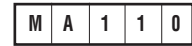

On request - Modulo 5 cm
 Coding over 3 characters
 E.g. 50 cm = 050; 1 m = 100



On request - Modulo 5 cm
 Coding over 3 characters
 E.g. 50 cm = 050; 9 m = 900



On request - Modulo 5 cm
 Coding over 3 characters
 E.g. 50 cm = 050; 1.10 m = 110

References: (products available in stock)	Codes
	P01120661
	P01120662

Model MA130 30-300-3000/3 Three-phase

Current	30 A AC	300 A AC	3,000 A AC
Output	100 mV/A	10 mV/A	1 mV/A

DESCRIPTION

The MiniFlex® MA130 is a flexible sensor comprising an active part (Rogowski coil) linked to a casing containing electronics.

Unlike a current clamp with magnetic circuits, the MiniFlex® models are flexible and are not subject to magnetic saturation constraints, so they offer excellent linearity, low phase shift and a large dynamic range for measurement (up to several kA) while remaining easy to use.

The sensors' flexibility makes it simple to clamp and measure any conductor, whatever its type (cable, busbar, strand, etc. and accessibility).

The click-lock system for opening and closing the coil is specially designed for use with safety gloves.

The MiniFlex® MA130 can be connected to the AC voltage inputs (mV AC, V AC) of any power analyser, logger or measuring instrument equipped with BNC plugs.

The MiniFlex® MA130 can be powered by batteries or a standard external power supply. If the power supply fails, the instrument's batteries take over.

To maximize the battery life, the MiniFlex® MA130 model has an automatic standby system which can be deactivated at start-up to perform long-term measurement campaigns. The MiniFlex® MA130 model has 3 green, yellow and red LEDs indicating, respectively, the power supply status, the status of the automatic standby function and any overruns of the measurement capacity.



SPECIFICATIONS FOR CURRENT MEASUREMENT ⁽¹⁾

Calibre (I _N)	30 A	300 A	3000 A
Measurement range in use	0.5 .. 30 A AC	0.5 .. 300 A AC	0.5 .. 3000 A AC
Specified measurement range	5 .. 30 A AC	5 .. 300 A AC	50 .. 3000 A AC
Output/input ratio	100 mV / A	10 mV / A	1 mV / A
Bandwidth at -3 dB	10 Hz .. 20 kHz	10 Hz .. 20 kHz	10 Hz .. 20 kHz
Frequency limitation	Null	Null	See curve
Intrinsic uncertainty	≤ 1 % + 4 mV	≤ 1.5 % + 0.4 mV (I < 10 % I _N) ≤ 1 % + 0.4 mV (I ≥ 10 % I _N)	≤ 1.5 % + 0.04 mV (I < 10 % I _N) ≤ 1 % + 0.04 mV (I ≥ 10 % I _N)
Phase shift at 50 Hz	≤ 1° (0.5° typical)	≤ 1° (0.5° typical)	≤ 1° (0.5° typical)

ELECTRICAL SPECIFICATIONS ⁽¹⁾

- Operating voltage:**
 600 V_{RMS} (Cat. IV)
 1,000 V_{RMS} (Cat. III)
- Battery:**
 Two 1.5 V batteries (NEDA 15A, IEC LR6, AA)
 +5 VDC with a type B micro-USB connector
- Battery life ⁽²⁾:**
 500 hours typical
 3,000 10-minute approx. measurements
- Consumption:**
 10 µA (OFF position)
 90 µA (sleep mode)
- Battery level indication:**
 Flashing green LED (batteries voltage > 2 V)
- Influence of battery voltage:**
 ≤ 0.1 % (0.02 % typical) from 3.1 V to 2 V
- Influence of temperature:**
 ≤ 0.5 % (0.15 % typical) of output signal per 10 °K
- Influence of relative humidity:**
 ≤ 0.5 % (0.2 % typical) of output signal
- Influence of conductor position in the sensor ⁽³⁾:**
 ≤ 2.5 % (1 % typical)
- Influence of sensor deformation ⁽⁴⁾:**
 ≤ 1 % (0.2 % typical)
- Influence of adjacent conductor ⁽⁵⁾:**
 ≤ I_{ADJ} x 1 % (2 % near click-lock system)
 (0.2 % typical)
- Input impedance of the measuring instrument:**
 ≥ 1 MΩ
- Common mode rejection ⁽⁶⁾:**
 ≤ 80 dB (100 dB typical)
- Influence of the measurement instrument's impedance Z:**
 ≤ 0.1 % at 10 kΩ

MECHANICAL SPECIFICATIONS

- **Clamping capacity:**
Model 250 mm: Ø max 70 mm
- **Bending radius:**
≥ 20 mm
- **Operating temperature:**
-10 °C to +55 °C
- **Storage temperature:**
-40 °C to +70 °C
- **Max. temperature of clamped conductor (measured):**
90 °C for 10 minutes max.
- **Relative humidity for operation:**
0 to 85 % RH with a linear decrease above 35 °C
- **Operating altitude:**
0 to 2,000 m
- **Casing protection rating (leakproofing):**
Casing: IP54
Sensor: IP 67
According to IEC 60529 Ed. 2.2-2013

- **Drop test:**
1 m (IEC 68-2-32)
- **Self-extinguishing capability:**
Casing: UL94-V2
Sensor: UL94 V0
- **Dimensions:**
Casing: 120 x 55 x 39 (overall)
Length of intermediate cable linking the cable/processing unit: 3 m
Length of output cable: 0.5 m
Ø of sensor: 6 mm
Connection cable Ø: 4 mm
- **Weight:**
500 g
- **Colours:**
Sensor: red
Sensor closing system: dark grey
Casing: dark grey
- **Output:**
3 coaxial cables with reinforced or double isolation terminated by 1 black isolated male BNC plug

SAFETY SPECIFICATIONS

- **Electrical safety:**
Class II equipment with double or reinforced insulation between the primary and the secondary (winding connected to the connection cable) as per EN 61010-1 and 61010-2-032:
Sensor:
- Type B
- 600 V Cat. IV / 1,000 V Cat. III, pollution degree 2
Casing:
- 600 V Cat. III between the BNC output and the external enclosure of the casing
- **Electromagnetic compatibility (EMC):**
Compliance for industrial environments as per EN 61326-1 Ed. 02-2012:
- Immunity to radiated fields: at 3 V/m, error ≤ 5 % of measurement range (criterion A)

3,000 A calibre

Frequency limitation according to amplitude

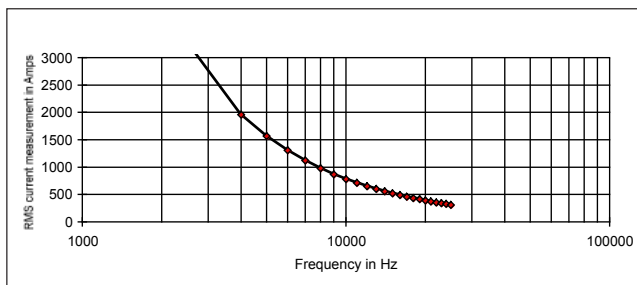

- (1) Conditions of reference: 23 °C ± 5 °K, 20 % to 75 % RH
Battery voltage 3.2 V ± 0.1 V DC
Frequency and form of signal measured: 30 to 440 Hz sinusoidal
Continuous magnetic field < 40 A/m
Absence of external AC magnetic field
Absence of external electrical field
Measured conductor centred in the circular sensor (coil) after operation for 1 minute
Measurement instrument input impedance ≥ 1 MΩ
- (2) With 3,000 mA/h batteries, for a supplied voltage between 3.2 V and 1.8 V (1.6 V to 0.9 V per battery), giving an average voltage of 2.8 V
- (3) Whatever the conductor's position within the loop, as long as the sensor is not distorted (circular sensor)
- (4) Oblong shape
- (5) Adjacent conductor carrying an AC current I_{adj} , in contact with the sensor
- (6) For a 600 V voltage applied between the enclosure and the secondary
- (7) Delivered with a set of 3 female BNC/ Ø 4 mm isolated male banana adapters with 19 mm spacing and a set of identifiers (12 colours)

To order	Reference
MiniFlex® MA130 30-300-3,000 A / 3 V, length 250 mm, Output via 3 coaxial cables terminated by 1 isolated male BNC plug	P01120663

Flexible probe for AC current

Model MA130 30-300-3000/3 triphase

MiniFlex® series



FREQUENCY RESPONSE

30 A calibre

Typical error on measurement according to frequency for a current of 20 A

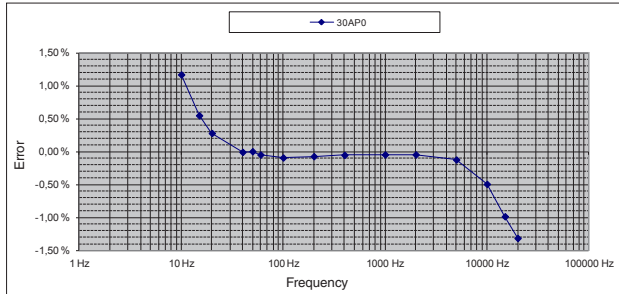

Typical phase shift according to frequency for a current of 20 A

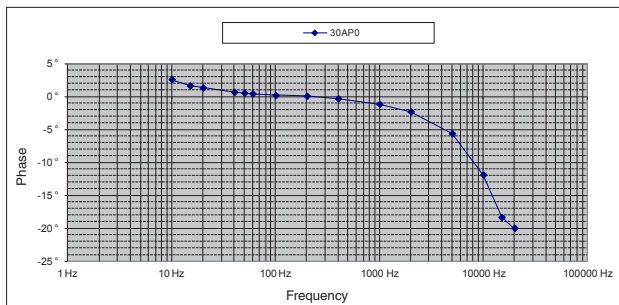

300 A calibre

Typical error on measurement according to frequency for a current of 20 A

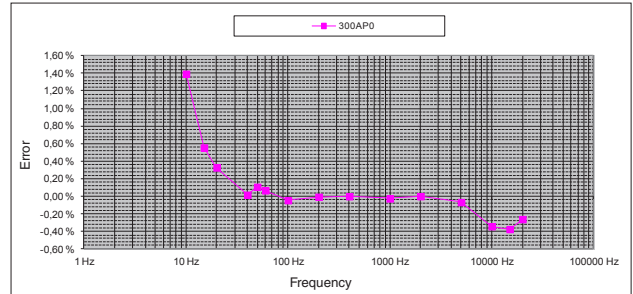

Typical phase shift according to frequency for a current of 20 A

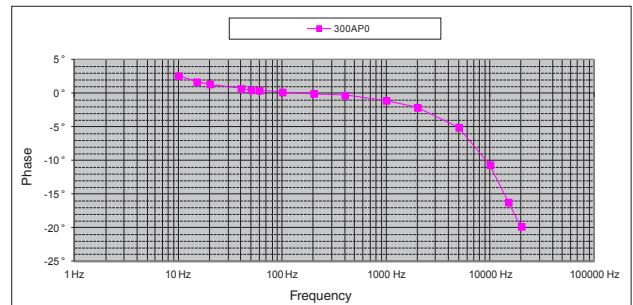

3,000 A calibre

Typical error on measurement according to frequency for a current of 20 A

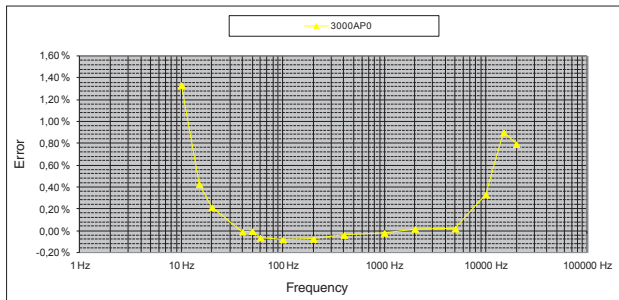

Typical phase shift according to frequency for a current of 20 A

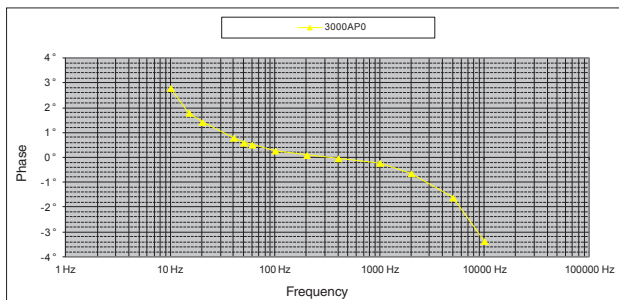

Flexible probe for AC current

Model MA130 on request

MiniFlex® series

CONFIGURATIONS

Level 1

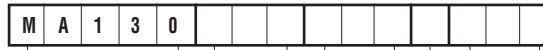

1 Category

2 Lead length in centimeters

Min value : **015** (15 cm)
 Max value : **100** (100 cm = 1 m)

Increment per 5 cm section

3 Length of connection lead in centimeters

Min value : **050** (50 cm)
 Max value : **995** (9.95 m)

Increment per 5 cm section

4 Output via

- A:** coaxial cable of the length to be defined in **5** terminated by a 600 V CAT III isolated male BNC socket
- B:** cable 50 cm long terminated by 2 red/black Ø 4 mm isolated male banana plugs rated 600 V CAT IV
- C:** shielded cable with 2 bared, tin-plated conductors of the length to be defined in **5**, rated 600 V CAT III

5 Output cable length in cm

If **4** = "A"

Min value : **050** (50 cm)
 Max value : **110** (1.10 m)

Increment per 5 cm section

If **4** = "C"

Min value : **050** (50 cm)
 Max value : **995** (9.95 m)

Increment per 5 cm section

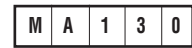

On request - Modulo 5 cm
 Coding over 3 characters
 E.g. 50 cm = 050; 1 m = 100



On request - Modulo 5 cm
 Coding over 3 characters
 E.g. 50 cm = 050; 9 m = 900

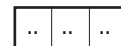

On request - Modulo 5 cm
 Coding over 3 characters
 E.g. 50 cm = 050; 1.10 m = 110

Reference: (products available in stock)	Codes
	P01120663

Current	45 A peak	450 A peak
Output	100 mV/A	10 mV/A

DESCRIPTION

The MiniFlex® MA200 is a flexible sensor comprising an active part (Rogowski coil) linked to a casing containing electronics.

Unlike a current clamp with magnetic circuits, the MiniFlex® models are flexible and are not subject to magnetic saturation constraints, so they offer excellent linearity, low phase shift and a large dynamic range for measurement (up to several kA) while remaining easy to use.

The oscilloscope probes in the MA200 series are specially designed for viewing alternating currents in order to assess the transition and propagation times on electrotechnical equipment.

The sensors' flexibility makes it simple to clamp and measure any conductor, whatever its type (cable, busbar, strand, etc.) and accessibility.

The click-lock system for opening and closing the coil is specially designed for use with safety gloves.

The casing can be connected to any oscilloscope equipped with an AC voltage input.

SPECIFICATIONS FOR CURRENT MEASUREMENT ⁽¹⁾

Calibre	30 A	300 A
Measurement range in use	0.5 .. 30 A AC (45 A peak)	0.5 .. 300 A AC (450 A peak)
Specified measurement range ⁽²⁾	5 .. 30 A AC (45 A peak)	5 .. 300 A AC (450 A peak)
Output/input ratio	100 mV/A	10 mV/A
% Accuracy of output signal	≤ 1 % + 0.3 A	
Phase shift at 1 kHz	≤ 1.5°	
Residual current (noise) at I = 0	≤ 0.5 A _{RMS}	
Output impedance	1 kΩ	

FREQUENCY MEASUREMENT SPECIFICATIONS ⁽¹⁾

Calibre	30 A	300 A
Bandwidth at -3 dB	2 Hz .. 1 MHz	2 Hz .. 1 MHz
Rise time ⁽³⁾ (10 to 90 %)	0.3 μs (typical)	0.24 μs (typical)
Fall time ⁽⁴⁾ (10 to 90 %)	0.3 μs (typical)	0.24 μs (typical)
Propagation time ⁽⁵⁾ (to 10 %)	0.4 μs (typical)	0.3 μs (typical)
Insertion impedance at 10 kHz	< 0.05 mΩ	



ELECTRICAL SPECIFICATIONS ⁽¹⁾

- **Operating voltage:**
600 V_{RMS} (Cat. IV)
1,000 V_{RMS} (Cat. III)
- **Battery:**
9 V alkaline battery (NEDA 1604A, IEC 6LR61)
- **Battery life:**
100 hours typical
- **Typical consumption:**
3.6 mA typical
- **Battery level indication:**
Green LED when > 7.0 V approx.
- **Influence of battery voltage:**
≤ 0.1 % from 9 V to 7 V
- **Influence of temperature:**
≤ 0.2 % / 10 °K
- **Influence of humidity:**
≤ 0.5 % from 10 % to 90 % RH without condensation
- **Influence of conductor position in the sensor ⁽⁸⁾:**
≤ 2.5 %
- **Influence of sensor deformation ⁽⁶⁾:**
≤ 1 %
- **Influence of an adjacent conductor with circulating AC current ⁽⁷⁾:**
≤ 1.5 % or 36.5 dB
- **Common mode rejection:**
- between enclosure and secondary: ≤ 75 dB
- between sensor and secondary: ≤ 80 dB
- **Influence of the measurement instrument's impedance Z:**
0.1 % / Z (in MΩ)

MECHANICAL SPECIFICATIONS

- **Clamping capacity:**
Model 170 mm: Ø max 45 mm
Model 250 mm: Ø max 70 mm
- **Operating temperature:**
-10 °C to +55 °C
- **Storage temperature:**
-40 °C to +70 °C
- **Max. temperature of clamped conductor (measured):**
≤ 90 °C
- **Relative humidity for operation:**
0 to 85 % RH with a linear decrease above 35 °C
- **Operating altitude:**
0 to 2,000 m
- **Storage altitude:**
≤ 12,000 m
- **Casing protection rating (leakproofing):**
Casing: IP50
Sensor: IP50
According to EN 60529/A1 Ed. 06/2000
- **Shock resistance:**
IK04 according to NF EN 50102 Ed. 1995
- **Self-extinguishing capability:**
Casing: UL94-V2
Sensor: UL94 V0
- **Dimensions:**
Casing: 140 x 64 x 28 mm
Connector lead: 2 m (connects sensor to casing)
Ø of sensor: 5.5 mm approx.
Connection cable Ø: 3 mm approx.

- **Colours:**
Sensor: red
Sensor closing system: dark grey
Sensor locking tab: yellow
Casing: Dark grey
- **Output:**
According to model:
Coaxial cable 40 cm long, terminated by an insulated BNC plug

SAFETY SPECIFICATIONS

- **Electrical safety:**
Class II equipment with double or reinforced insulation between the primary and the secondary (winding connected to the connection cable) as per EN 61010-1 and 61010-2-032:
- 1,000 V Cat. III, pollution degree 2
- 600 V Cat. IV, pollution degree 2
- Type-B sensor
- 600 V Cat. III between the BNC output and the external enclosure of the casing
- **Electromagnetic compatibility (EMC):**
Complies with the IEC 61326 (Ed. 1997) + A1 (Ed. 1998)
- Adequate immunity to disturbances for industrial environments
- Adequate immunity to disturbances for residential environments

(1) Conditions of reference: 23 °C ± 5 °K, 20 % to 75 % RH
Battery voltage: 9 V ± 0.5 V
Continuous external DC magnetic field (earth field) < 40 A/m
Absence of external AC magnetic field
External electrical field < 1 V/m
Position of conductor measured: centred in the measurement coil
Shape of measurement coil: quasi-circular
Measurement instrument input impedance (oscilloscope) ≥ 1 MΩ
Frequency and form of signal measured: 40 to 400 Hz sinusoidal.

(2) Measurement range for the specifications indicated in this document.

(3) Rise Time (t_r)

(4) Fall Time (t_f)

(5) Delay Time (d_t)

(6) Oblong shape

(7) Adjacent conductor 1 cm from sensor; ≤ 3 % or 30.5 dB near click-lock system

(8) ≤ 6 % near click-lock system

(9) Typical curve obtained by mathematical modelling

To order	Reference
MiniFlex® MA200 30-300 A / 3 V, length 170 mm with operating manual and Battery	P01120570
MiniFlex® MA200 30-300 A / 3 V, length 250 mm with operating manual and Battery	P01120571

Flexible probe for AC current

MiniFlex® series

Model MA200 30-300/3 (insulated AC current probe)

170 mm LOOP - 30 A CALIBRE

Frequency and phase responses ⁽⁹⁾

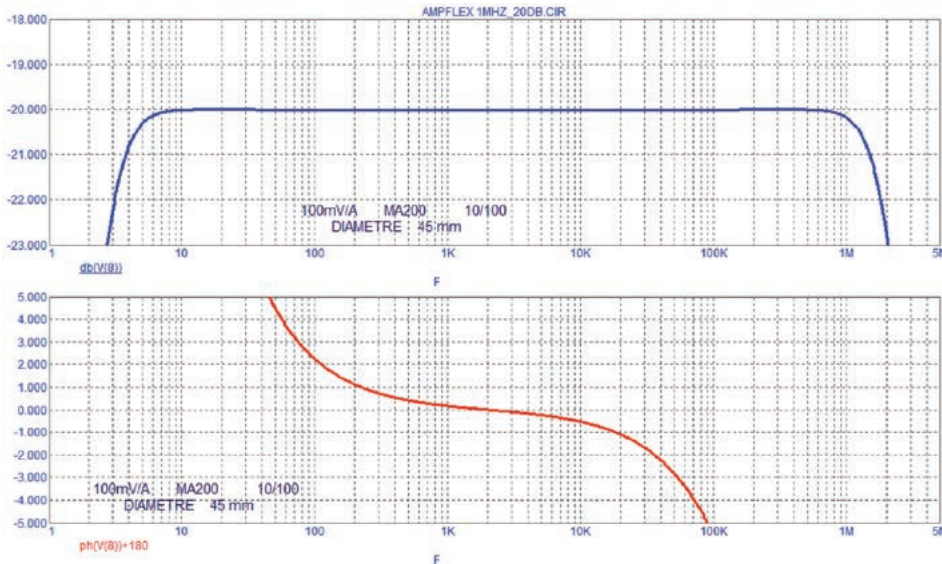

Pulse response

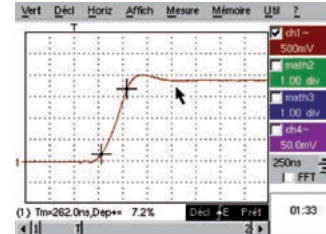

170 mm LOOP- 300 A CALIBRE

Frequency and phase responses ⁽⁹⁾

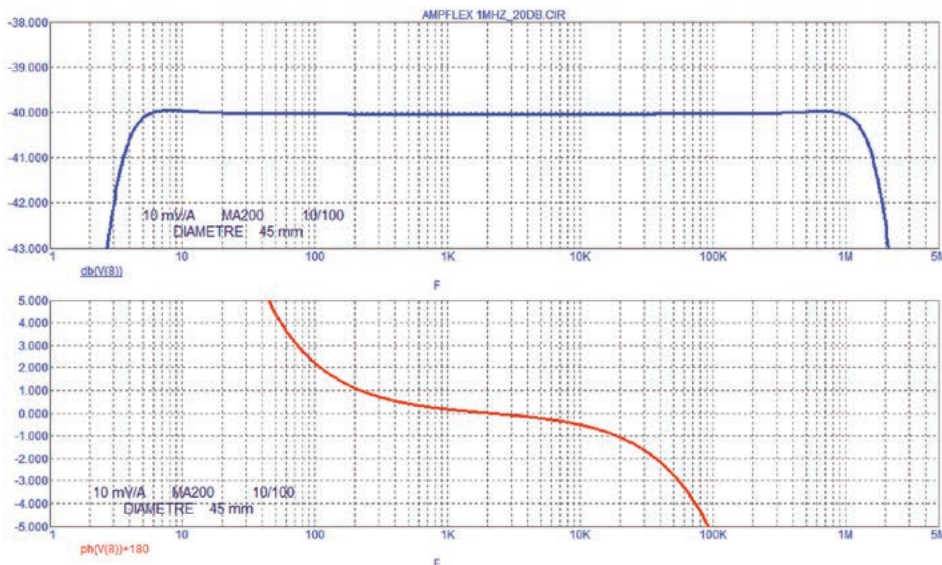

Pulse response

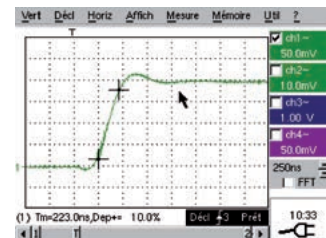

Flexible probe for AC current

MiniFlex® series

Model MA200 30-300/3 (insulated AC current probe)

250 mm LOOP - 30 A CALIBRE

Frequency and phase responses ⁽⁹⁾

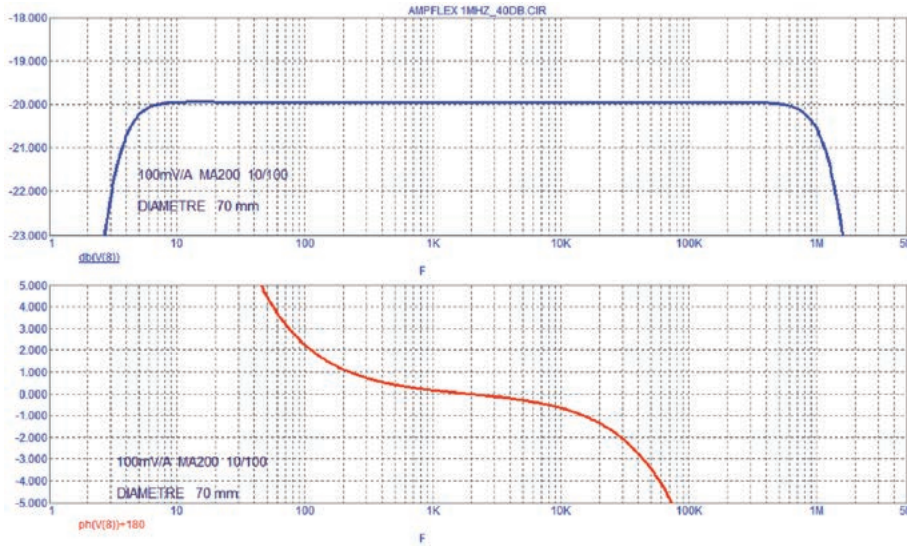

Pulse response

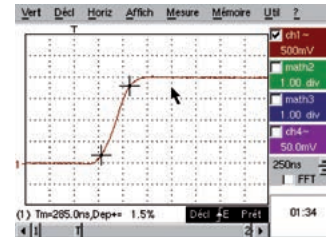

250 mm LOOP - 300 A CALIBRE

Frequency and phase responses ⁽⁹⁾

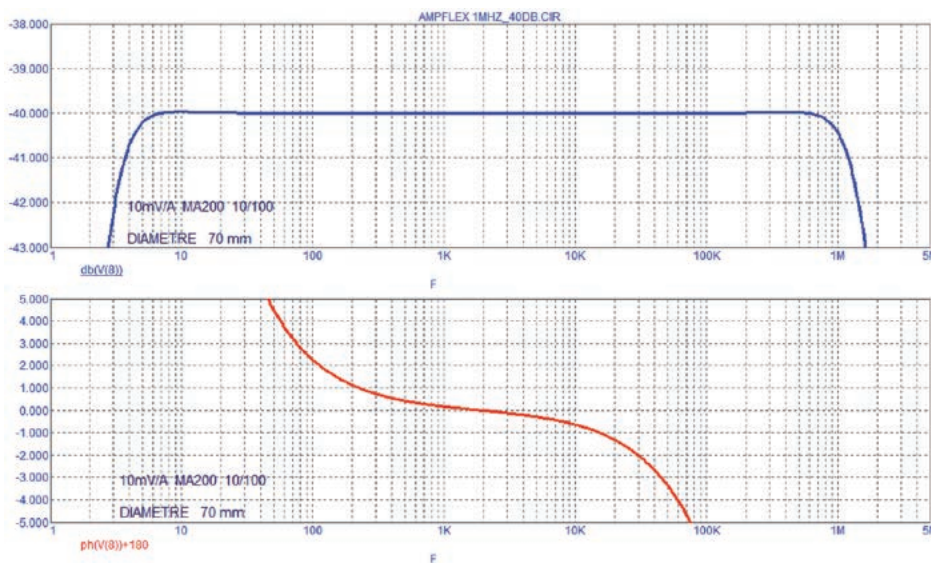

Pulse response

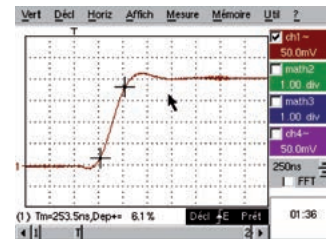

Model MA200 3000/3 (insulated AC current probe)

Current	4500 A peak
Output	1 mV/A

DESCRIPTION

The MiniFlex® MA200 is a flexible sensor comprising an active part (Rogowski coil) linked to a casing containing electronics.

Unlike a current clamp with magnetic circuits, the MiniFlex® models are flexible and are not subject to magnetic saturation constraints, so they offer excellent linearity, low phase shift and a large dynamic range for measurement (up to several kA) while remaining easy to use.

The oscilloscope probes in the MA200 series are specially designed for viewing alternating currents in order to assess the transition and propagation times on electrotechnical equipment.

The sensors' flexibility makes it simple to clamp and measure any conductor, whatever its type (cable, busbar, strand, etc.) and accessibility.

The click-lock system for opening and closing the coil is specially designed for use with safety gloves.

The casing can be connected to any oscilloscope equipped with an AC voltage input.



SPECIFICATIONS FOR CURRENT MEASUREMENT ⁽¹⁾

Calibre	3,000 A
Measurement range in use	0.5 .. 3,000 A AC (4,500 A peak)
Specified measurement range ⁽²⁾	5 .. 3,000 A AC (4,500 A peak)
Output/input ratio	1 mV/A
Accuracy in % of output signal	≤ 1 % + 0.3 A
Phase shift at 1 kHz	≤ 1.5°
Residual current (noise) at I = 0	≤ 0.5 A _{RMS}
Output impedance	1 kΩ

FREQUENCY MEASUREMENT SPECIFICATIONS ⁽¹⁾

Calibre	3,000 A
Bandwidth at -3 dB ⁽⁶⁾	2 Hz .. 1 MHz
Rise time ⁽³⁾ (10 to 90 %)	0.3 μs (typical)
Fall time ⁽⁴⁾ (10 to 90 %)	0.3 μs (typical)
Temps from propagation ⁽⁵⁾ (to 10 %)	0.4 μs (typical)
Insertion impedance at 10 kHz	< 0.05 mΩ

ELECTRICAL SPECIFICATIONS ⁽¹⁾

- **Operating voltage:**
600 V_{RMS} (Cat. IV)
1,000 V_{RMS} (Cat. III)
- **Battery:**
9 V alkaline battery (NEDA 1604A, IEC 6LR61)
- **Battery life:**
100 hours typical
- **Typical consumption:**
3.6 mA typical
- **Battery level indication:**
Green LED when > 7.0 V approx.
- **Influence of battery voltage:**
≤ 0.1 % from 9 V to 7 V
- **Influence of temperature:**
≤ 0.6 % / 10 °K
- **Influence of humidity:**
≤ 0.5 % from 10 % to 90 % RH without condensation
- **Influence of conductor position in the sensor ⁽⁹⁾:**
≤ 2.5 %
- **Influence of sensor deformation ⁽⁷⁾:**
≤ 1 %
- **Influence of an adjacent conductor with circulating AC current ⁽⁸⁾:**
≤ 1.5 % or 36.5 dB
- **Common mode rejection:**
- between enclosure and secondary: ≤ 75 dB
- between sensor and secondary: ≤ 80 dB
- **Influence of the measurement instrument's impedance Z:**
0.1 % / Z (in MΩ)

MECHANICAL SPECIFICATIONS

- **Clamping capacity:**
Model 350 mm: Ø max 100 mm
- **Operating temperature:**
-10 °C to +55 °C
- **Storage temperature:**
-40 °C to +70 °C
- **Max. temperature of clamped conductor (measured):**
≤ 90 °C
- **Relative humidity for operation:**
0 to 85 % RH with a linear decrease above 35 °C
- **Operating altitude:**
0 to 2,000 m
- **Storage altitude:**
≤ 12,000 m
- **Casing protection rating (leakproofing):**
Casing: IP50
Sensor: IP50
According to EN 60529/A1 Ed. 06/2000
- **Shock resistance:**
IK04 according to NF EN 50102 Ed. 1995
- **Self-extinguishing capability:**
Casing: UL94 V2
Sensor: UL94 V0
- **Dimensions:**
Casing: 140 x 64 x 28 mm
Connector lead: 2 m (connects sensor to casing)
Ø of sensor: 5.5 mm approx.
Connection cable Ø: 3 mm approx.

Colours:

Sensor: red
Sensor closing system: dark grey
Sensor locking tab: yellow
Casing: dark grey

Output:

Coaxial cable 40 cm long, terminated by an insulated BNC plug

SAFETY SPECIFICATIONS

Electrical safety:

Class II equipment with double or reinforced insulation between the primary and the secondary (winding connected to the connection cable) as per EN 61010-1 and 61010-2-032:
- 1,000 V Cat. III, pollution degree 2
- 600 V Cat. IV, pollution degree 2
- Type-B sensor
- 600 V Cat. III between the BNC output and the external enclosure of the casing

Electromagnetic compatibility (EMC):

Complies with the IEC 61326 (Ed. 1997) + A1 (Ed. 1998)
- Adequate immunity to disturbances for industrial environments
- Adequate immunity to disturbances for residential environments

- (1) Conditions of reference: 23 °C ± 5 °K, 20 % to 75 % RH
Battery voltage: 9 V ± 0.5 V
Continuous external DC magnetic field (earth field) < 40 A/m
Absence of external AC magnetic field
External electrical field < 1 V/m
Position of conductor measured: centred in the measurement coil
Shape of measurement coil: quasi-circular
Measurement instrument input impedance (oscilloscope) ≥ 1 MΩ
Frequency and form of signal measured: 40 to 400 Hz sinusoidal.
- (2) Measurement range for the specifications indicated in this document.
- (3) Rise Time (t_r)
- (4) Fall Time (t_f)
- (5) Delay Time (t_d)

(6) Frequency limitation according to amplitude

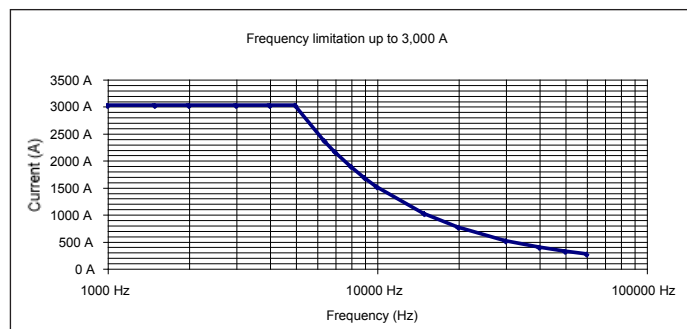

(7) Oblong shape

(8) Adjacent conductor 1 cm from sensor; ≤ 3 % or 30.5 dB near click-lock system

(9) ≤ 6 % near click-lock system

(10) Typical curve obtained by mathematical modelling

To order	Reference
MiniFlex® MA200 3,000 A / 3 V, length 350 mm with operating manual and battery	P01120572

Flexible probe for AC current

MiniFlex® series

Model MA200 3000/3 (insulated AC current probe)

3,000 A CALIBRE

Frequency and phase responses ⁽¹⁰⁾

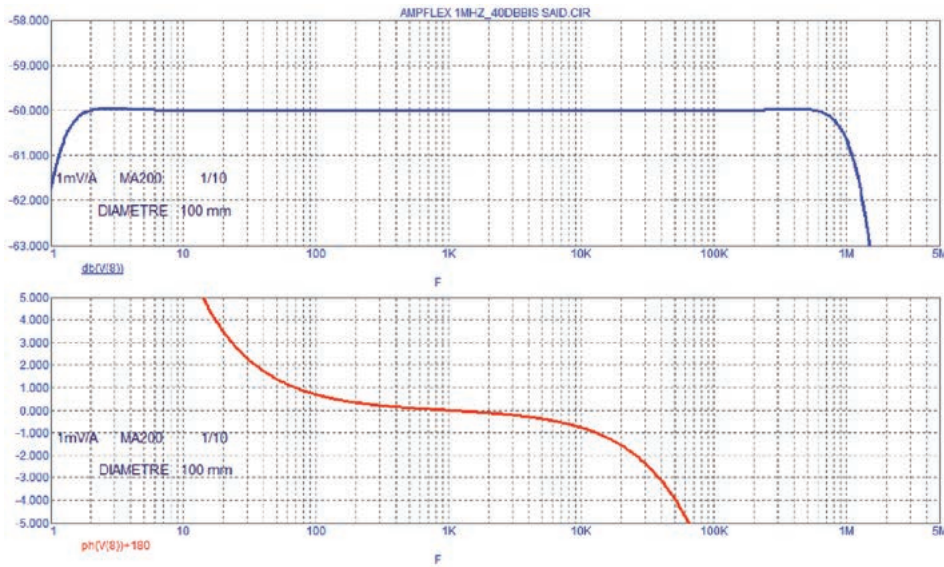

Pulse response

