

Deutsch Industrial UK  
Stanier Road  
St. Leonards On Sea  
East Sussex TN 38 9RF  
England  
Ph. 44 (0) 1424 852 722  
Fax 44 (0) 1424 855 979  
industrialuk@deutsch.net

Deutsch Industrial Europe  
Fraunhoferstrasse 11b  
82152 Martinsried  
Germany  
Ph. +49 (0) 89 899157-0  
Fax +49 (0) 89 857 4684  
info.eu@deutsch.net

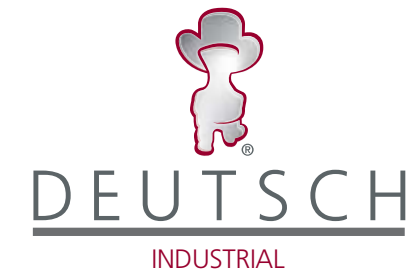

Deutsch Industrial US  
3850 Industrial Ave.  
Hemet, CA 92545  
USA  
Ph. +1 (951) 765-2250  
Fax +1 (951) 765-2255  
insidesales-ipd@deutsch.net

Deutsch Industrial Japan  
NIHON Deutsch Ltd.  
44-10, Ohyamakanai-cho  
Itabashi-ku, Tokyo 173-0024  
Japan  
Ph. + 81-3-5995-5192  
Fax + 81-305995-5193  
rtakemura@nihon-deutsch.co.jp



3850 Industrial Avenue, Hemet, California 92545 Tel.: (951) 765-2250 - Fax: (951) 765-2255  
Web: www.deutsch.net - Edition 2007

DT Series Technical Manual





**Table of Contents**

Introduction	2, 3	Contact Retention System	10
Features & Benefits	3	Assembly Contact Insertion / Removal	11
Product Line Overview	4	Accessories	12
Material Specifications	5	Shrink Boot Adaptor	12
General Specifications	5	Removal Tools / Sealing Plugs	12
Ordering Information	6	DT Mounting Clips	13
Insert Arrangements	7, 8	Back Shells	14, 15
Contacts & Application Data	9		

**Environmentally-Sealed Transportation Connectors**



**Deutsch DTM Series**

Deutsch DTM Series of transportation connectors feature a miniature contact with an enhanced design based on the world class, field-proven Deutsch DT Series.

The DTM is the connector to be used in harsh environmental application where reliable signal circuits are critical to operating performance. Typical applications include on or around the engine, the transmission and under the hood.

**Deutsch DT Series**

An environmentally-sealed connector designed specifically for cable to cable applications on the engine or transmission, under the hood, on the chassis or in the cab. On signal level circuits in harsh environmental conditions, where even a small degradation in connection may be critical, the Deutsch DT Series general purpose connectors will provide the reliability and performance at the lowest cost.



**Deutsch DTP Series**

Deutsch's DTP Series connectors are the answer to all of your most demanding power application requirements. DTP Series connectors offer the proven reliability and quality of Deutsch's DT Series, combined with the added flexibility of using power contacts.



**Deutsch DTHD Series**

Deutsch developed the DTHD Series for those applications requiring a complete, environmentally sealed, single power circuit termination. The plug features an integral coupling latch that provides tactile and audible feedback during coupling. The rugged thermoplastic receptacle is designed as an inline for cable to cable applications and is supplied with an integral Vee-Groove to accept mounting, clips, brackets and flanges.



**Deutsch DT Bussed Series**

Utilizing the Deutsch DT receptacle shell, Deutsch has combined the rugged characteristics of the DT product line with a bussing device allowing the elimination of various harness splices. By using internal stamped bussed contacts this product can be configured in whatever arrangement meets your individual needs in the DT shell size that matches your requirements. Complete bussing flexibility in a compact, economical package.

Features	Benefits
Integral Connector Latch	Tactile and Audible Assembly Feedback
Rugged Thermoplastic Housing	Field Proven Long Service Life
-55° C to +125° C Operating Temperature	Engine Compartment Rated
Available Configurations:	
DTM/DT 2, 3, 4, 6, 8 & 12 - Size 20/16	Meets Most Harness Design Requirements
DTP 2 & 4 - Size 12	
DTHD 1 - Size 4, 8 & 12	
Silicone Seals:	
DTM: Accepts AWG 22 - 16 wire	Seals on .053" to .120 dia.(1.35mm to 3.05mm)
DT: Accepts AWG 20 - 14 wire	Seals on .053" to .145 dia.(1.35mm to 3.68 mm)
DTP: Accepts AWG 14 - 10 wire	Seals on .097" to .170 dia.(2.46mm to 4.32mm)
DTHD: Accepts AWG 14 - 6 wire	Seals on .134 to .292 dia. (3.40mm to 7.42mm)
Crimp Contacts with Option of Gold or Nickel Finish, Solid or Stamped Construction	Low Costs, High Reliability Terminals for Data & Signal Transmission
Current rating all contacts @ 125° C no derating	
DTM - 7.5 Amps	
DT - 13 Amps	Meets Most Signal Requirements
DTP - 25 Amps	
DTHD - 25 to 100 Amps	
Fail-Safe Secondary Locks All (Except DTHD)	Positive Contact Retention
Hand Insertable/Removable Contacts	No Special Tools Required (Except DTHD)
Budget Minded	Low Installation Costs





## Product Line Overview

### Deutsch DTM Series

Deutsch DTM Series of transportation connectors feature a miniature contact with an enhanced design based on the world class, field-proven Deutsch "DT Series".

The DTM is the connector to be used in harsh environmental applications where reliable signal circuits are critical to operating performance. Typical applications include on or around the engine, the transmission and under the hood. In fact, everywhere data signals or critical electronic circuits go, the field proven Deutsch design of the DTM will provide reliable peak connector performance.

The low cost, size 20 contacts terminate AWG 16 to 22 gauge wire (0.5mm<sup>2</sup> to 1.5mm<sup>2</sup>). Closed entry socket (female) contacts featuring spring action fingers are protected by a stainless steel hood. This allows for positive axial alignment while mating and prevents probe damage during testing.

Thermoplastic housings offer a wide operating temperature range (-55° C to +125° C). Silicone rear wire and internal peripheral interface seals allow the DTM to withstand moisture and fluids.

### Deutsch DT Series

Deutsch DT Series of environmentally-sealed, connectors are designed specifically for cable to cable applications on the engine or transmission, under the hood, on the chassis or in the cab. Where signal level circuits in harsh environmental conditions, where even a small degradation in connection may be critical, the Deutsch DT Series general purpose connectors will provide the reliability and performance at the lowest cost.

Thermoplastic (-55° C to + 125° C rated) housings and silicone seals are used to allow the connector to withstand conditions of extreme temperature and moisture. The connector may be employed with either solid-copper crimp type contacts for critical circuits or budget-minded stamped and formed contacts. In either selection, the spring action is designed in the socket and shrouded by a stainless steel hood that provides closed entry for positive axial alignment during mating, and eliminates probe damage from occurring. Contact insertion and withdrawal require no special tools and are retained in locked position by dielectric fingers, molded as an integral part of the housing. Secondary locks are assembled at the mating interfaces. If by chance the secondary locks are not properly seated during assembly, they will be pressed into locked position during the mating of the connector.

### Deutsch DTP Series

Building on both the DT and DTM design strengths, the DTP connector line was developed to fill the need for higher amperage, multi-pin, inexpensive connectors. The series meets the same specifications as the DTM and DT but offers the designer the ability to use multiple 12 gauge contacts, each with a 25 amp continuous capacity, within a single shell.

Based on the DTM overall design, it offers the protected interfacial seal located within the receptacle shell. Standard multi-seal grommet is used in both the plug and receptacle. Currently available in two and four pin configurations.

### Deutsch DT Bussed Series

These standard "DT" receptacle shells feature internal pin type contact buss bar arrangements that allow common connections from 3 to 12 size 16 contacts. Buss bars are available in standard nickel or gold to match common Deutsch Industrial contacts.

Other features include the use of standard "DT" plugs to mate with these environmental receptacles. Plugs with any Deutsch modification are intermatable.

### Deutsch DTHD Series

Deutsch developed the DTHD Series for those applications requiring a complete, environmentally sealed, single power circuit termination. DTHD plugs and receptacles can be permanently assembled with thermoplastic end caps that prevent removal of the silicone wire seal grommets. Designed for diesel engine, electronic fuel injectors, automatic transmissions, ABS brakes and other applications that involve fuel and oil exposure. These end caps provide the additional reliability required for critical wiring circuits.



## MATERIAL SPECIFICATIONS

### Plug/Receptacle

Shell: Thermoplastic  
Wedge: Thermoplastic  
Grommet: Silicone Rubber

### Contacts

Pin: Copper Alloy  
Socket: Copper Alloy  
Finish: Nickel (optional - gold) Plated

### Sealing Plugs

Thermoplastic: (All sizes)

## GENERAL SPECIFICATIONS

### Dielectric Withstanding Voltage

Current leakage less than 2 milliamps at 1500 VAC

### Insulation Resistance:

1000 megohms minimum at 25° C.

### Current Rating (Contact current rating @ 125° C (continuous))

- Size 20: 7.5 amps
- Size 16: 13 amps
- Size 12: 25 amps
- Size 8: 60 amps
- Size 4: 100 amps

### Submersion:

Properly wired and mated connection will withstand immersion under three feet of water without loss of electronic qualities or leakage.

### Fluid Resistance:

Connectors show no damage when exposed to most fluids used in industrial applications.

### Vibration:

No unlocking or unmating and exhibits no mechanical or physical damage after sinusoidal vibration levels of 20 G's at 10 to 2000 Hz in each of the three mutually perpendicular planes. No electrical discontinuities longer than 1 microsecond.

### Temperature:

Operative at temperatures from -55°C to +125°C. Continuous at rated current.

### Contact Retention:

Contacts withstand a minimum load of:

- 20 lbs (89N) for size 20
- 25 lbs (111N) for size 16
- 30 lbs (133N) for size 12
- 35 lbs (156N) for size 8
- 35 lbs (156N) for size 4

### Thermal Cycle:

No cracking, chipping or leaking after 20 test cycles from -55° C to +125° C.

### Durability:

No electrical or mechanical defects after 100 cycles of engagement and disengagement.

## CONTACT RESISTANCE

CONTACT SIZE	WIRE GAUGE AWG(mm <sup>2</sup> )	Test Current (Amps)	Resistance (mV) Solids	Resistance (mV) Stamped & Formed
20	20 (.50)	7.5	60	100
	18 (.80)	7.5	60	100
	16 (1.0)	7.5	60	100
16	20 (.50)	7.5	60	100
	18 (.80)	10	60	100
	16 (1.0)	13	60	100
12	14 (2.0)	18	60	100
	12 (3.0)	25	60	100
	8 (8.60)	60	60	N/A
8	10 (5.60)	60	60	N/A
	6 (13.0)	100	60	N/A

## WIRE SEALING RANGE

CONTACT SIZE	RECOMMENDED WIRE INSULATION O.D.	
	N-SEAL	E-SEAL
#20	.053-.120 (1.35-3.05)	N/A
#16	.088-.145 (2.24-3.68)	.053-.120 (1.35-3.05)
#12	.134-.170 (3.40-4.32)	.097-.158 (2.46-4.01)
#8	.190-.240 (4.83-6.10)	N/A
#4	.280-.292 (7.11-7.42)	N/A





### PART NUMBERING SYSTEM (DTM)

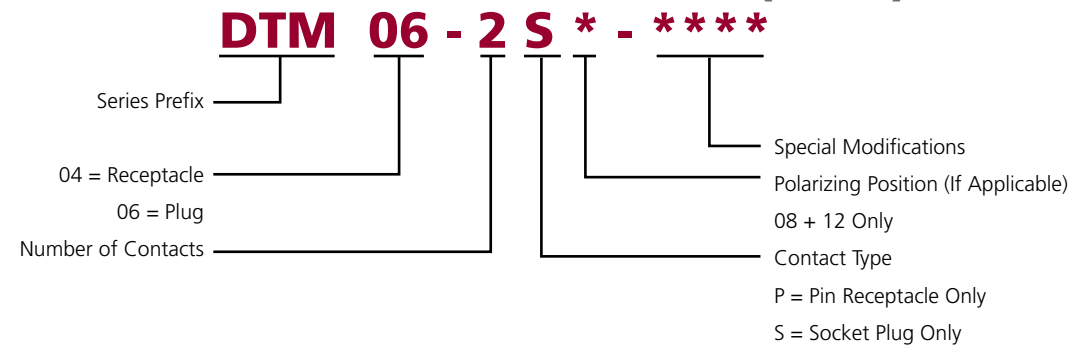

### PART NUMBERING SYSTEM (DT & DT Bussed)

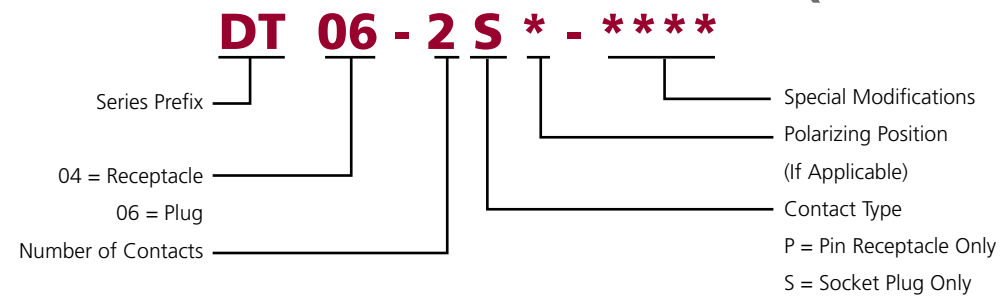

### PART NUMBERING SYSTEM (DTP)

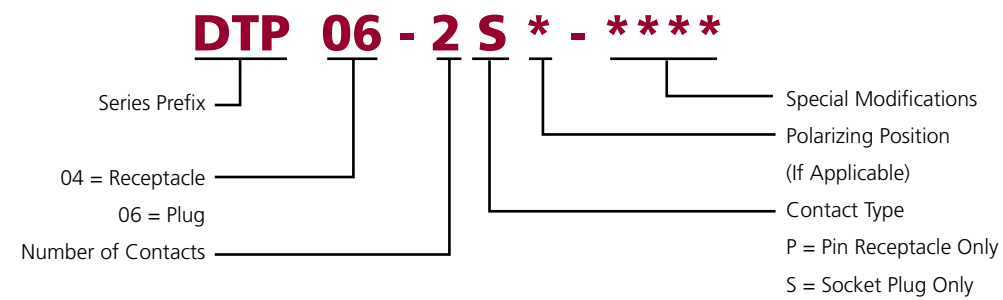

### PART NUMBERING SYSTEM (DTHD)

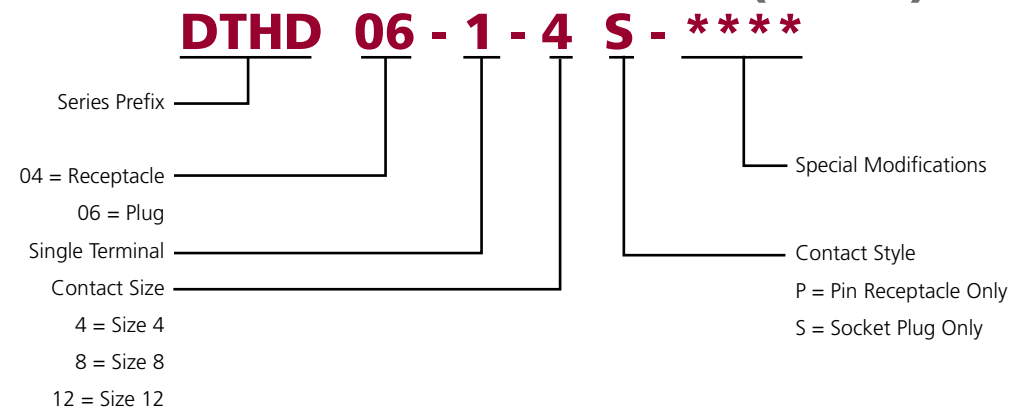

#### DTM Series Size 20 Contacts

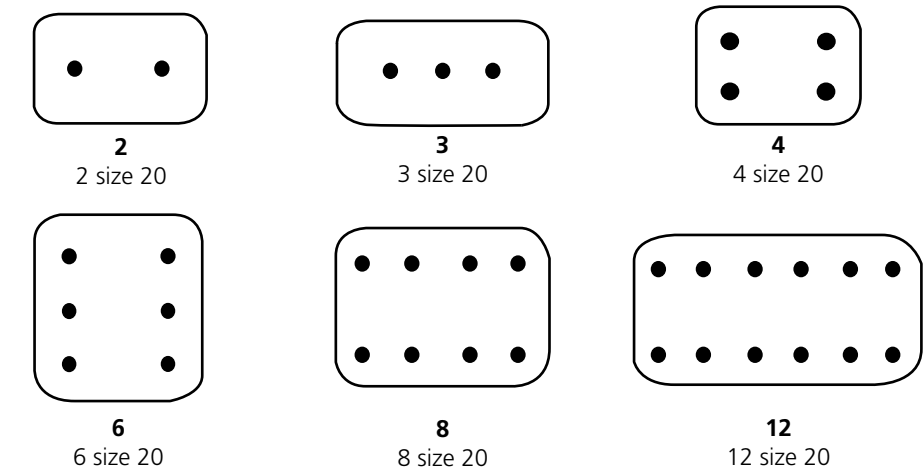

#### DT & DT BUSSED Series Size 16 Contacts

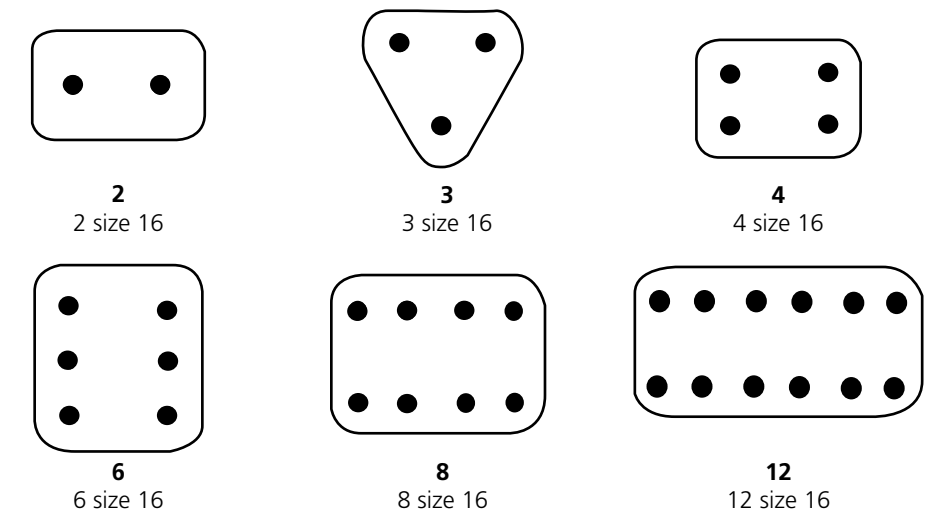

#### DTP Series Size 12 Contacts



#### DTHD Series Size 4, 8 & 12

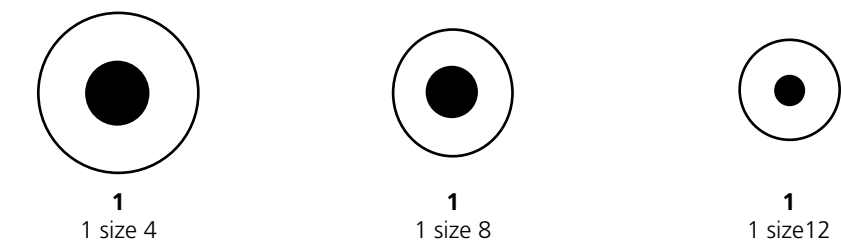



### DT Series BUSSED Arrangements

Standard DT Receptacles Bussed to Customer Specifications

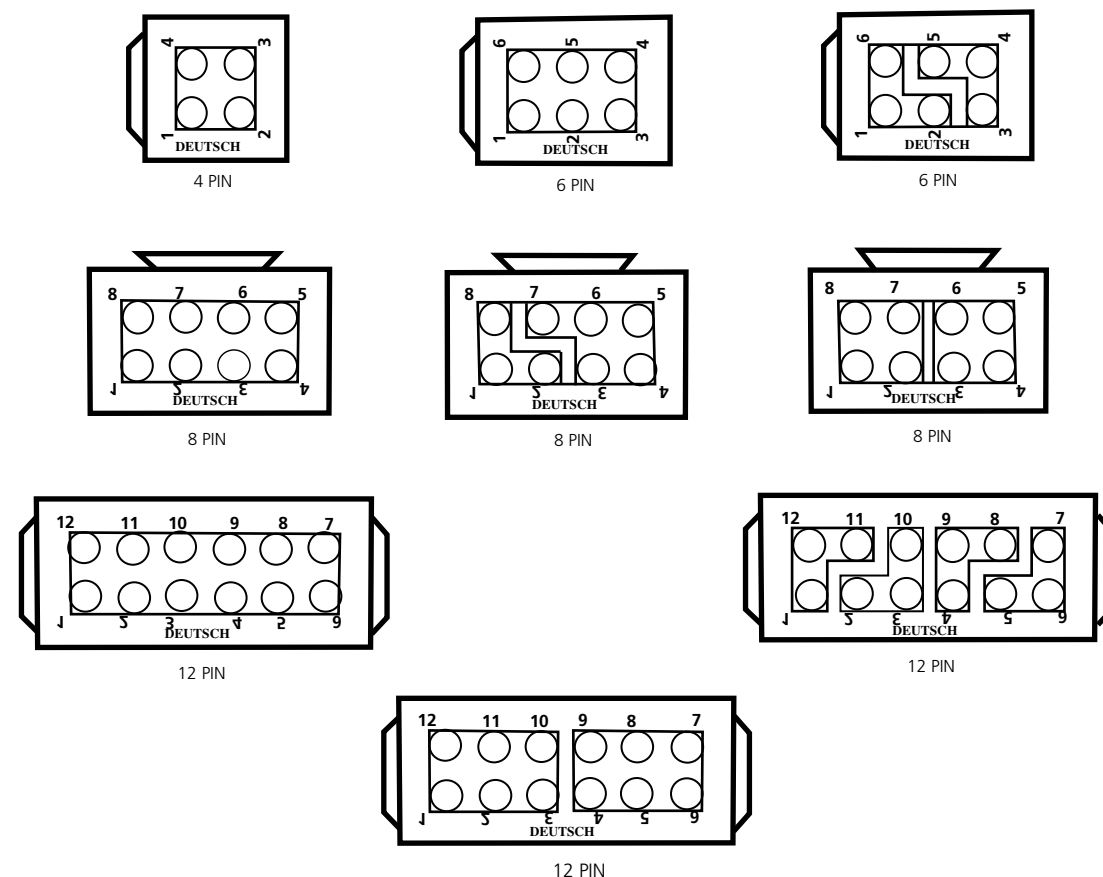

Arrangements shown are currently available. For additional arrangements contact factory.

ALL PART NUMBERS ARE FOR "BLACK"

MAX CURRENT RATINGS	NICKEL BUSS P/N	GOLD BUSS P/N	MATING PLUG P/N
4 PIN = 26 AMPS	DT04-4P-EP13	DT04-4P-EP12	DT06-4S-****
6 PIN = 39 AMPS	DT04-6P-EP13	DT04-6P-EP12	DT06-6S-****
3 PIN = 13 AMPS	DT04-6P-EP14	DT04-6P-EP15	DT06-6S-****
8 PIN = 52 AMPS	DT-8PB-P021	DT04-8PB-P016	DT06-08SB-****
5 PIN = 26 AMPS	DT04-8PB-P028	DT04-8PB-P029	DT06-08SB-****
4 PIN = 26 AMPS	DT04-8PB-P026	DT04-8PB-P027	DT06-08SB-****
3 PIN = 13 AMPS	DT04-3P-***	DT04-3P-***	DT06-3S-****
12 PIN = 76 AMPS	DT04-12PB-P021	DT04-12PB-P016	DT06-12SB-****
6 PIN = 39 AMPS	DT04-12PB-P026	DT04-12PB-P027	DT06-12SB-****
3 PIN = 13 AMPS	DT04-12PB-P030	DT04-12PB-P031	DT06-12SB-****

PLEASE CONSULT FACTORY FOR AVAILABILITY AND ALTERNATE KEYING



### CONTACTS AND APPLICATION DATA

#### Solid Contacts

SIZE	SOLID CONTACT PART NUMBERS		WIRE SIZE AWG (mm <sup>2</sup> )	RECOMMENDED STRIP LENGTH INCHES (mm)	MIN CONTACT RETENTION LBS (N)	REF CRIMP TENSILE LBS (N)	MAX RATED AMPS AT 125°C CONTINUOUS
	PIN	SOCKET					
20	0460-202-20**	0462-201-20**	20 (0.50)	.156-.218 (3.96 - 5.54)	20 (89)	20 (89)	7.5
16	0460-202-16**	0462-201-16**	16-20 (1.0 - 0.50)	.250 - .312 (6.35 - 7.92)	25 (111)	35-20 (156-89)	13
16	0460-215-16**	0462-209-16**	14 (2.0)	.250 - .312 (6.35 - 7.92)	25 (111)	70 (311)	13
12	0460-204-12**	0462-203-12**	12-14 (3.0 - 2.0)	.222 - .284 (5.64 - 7.21)	30 (134)	75-70 (334 - 311)	25
8	0460-204-08**	0462-203-08**	8-10 (8.0 - 5.0)	.430 - .492 (10.92 - 12.50)	35 (156)	125-90 (556-400)	60
4	0460-204-04**	0462-203-04**	6 (13.0)	.430-.492 (10.92-12.50)	35 (156)	300 (1334)	100

\* See Envelope Print 0425-205-0000. Consult factory for alternate finishes.

#### Solid Contacts

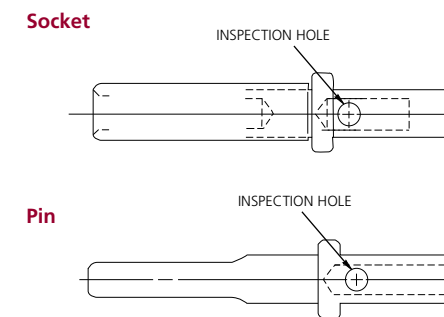

#### Stamped and Formed Contacts

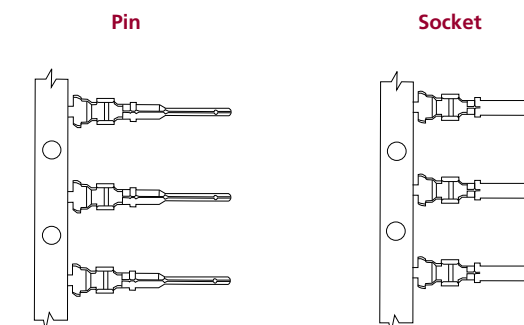

#### Stamped & Formed Contacts

SIZE	STAMPED & FORMED CONTACT PART NUMBERS		CARRIER STRIP IDENTIFICATION	WIRE SIZE AWG (mm <sup>2</sup> )	WIRE INSULATION O.D. RANGE	RECOMMENDED STRIP LENGTH INCHES (mm)	MIN CONT. RETENTION LBS (N)	REF CRIMP TENSILE LBS (N)	MAX RATED AMPS AT 125°C CONTINUOUS
	PIN	SOCKET							
20	1060-20-01**	1062-20-01**	20 - 01	16 - 22 (1.0 - 0.35)	.075 - .125 (1.91 - 3.15)	.150 - .200 (3.81 - 5.08)	20 (89)	20 - 10 (89 - 45)	7.5
20	1060-20-02**	1062-20-02**	20 - 02	16 - 22 (1.0 - 0.35)	.051 - .085 (1.30 - 2.16)	.150 - .200 (3.81 - 5.08)	20 (89)	20 - 10 (89 - 45)	7.5
20	N/A	1062-20-03**	20 - 03	16 - 22 (1.0 - 0.35)	.075 - .125 (1.91 - 3.15)	.150 - .200 (3.81 - 5.08)	20 (89)	20 - 10 (89 - 45)	7.5
16	1060-14-01**	1062-14-01**	14-16	14 - 18 (2.0 - .75)	.095 - .150 (2.41 - 3.81)	.150 - .200 (3.81 - 5.08)	25 (111)	25 (111)	13
16	1060-14-10**	1062-14-10**	14 - 16	14 - 18 (2.0 - .75)	.095 - .150 (2.41 - 3.81)	.150 - .200 (3.81 - 5.08)	25 (111)	25 (111)	13
16	1060-16-01**	1062-16-01**	16 - 18	14 - 18 (2.0 - .75)	.075 - .140 (1.91 - 3.55)	.150 - .200 (3.81 - 5.08)	25 (111)	25 (111)	13
16	1060-16-06**	1062-16-06**	0.5 - 1.0	16 - 20 (1.0 - 0.50)	.055 - .100 (1.40 - 2.54)	.150 - .200 (3.81 - 5.08)	25 (111)	25 - 15 (111 - 67)	13
16	1060-16-07**	1062-16-07**	0.75 - 2.0	14 - 18 (2.0 - .75)	.075 - .140 (1.91 - 3.55)	.150 - .200 (3.81 - 5.08)	25 (111)	25 (111)	13
16	1060-16-09**	1062-16-09**	16 - 18	14 - 18 (2.0 - .75)	.075 - .140 (1.91 - 3.55)	.150 - .200 (3.81 - 5.08)	25 (111)	25 (111)	13
16	1060-16-12**	1062-16-12**	1.0 - 2.5	12 - 16 (2.5 - 1.0)	.075 - .140 (1.91 - 3.55)	.175 - .225 (4.45 - 5.72)	25 (111)	25 (111)	13
16	N/A	1062-16-14**	14 - 16	12 - 16 (2.5 - 1.0)	.075 - .140 (1.91 - 3.55)	.175 - .225 (4.45 - 5.72)	25 (111)	25 (111)	13
12	1060-12-01**	1062-12-01**	12 - 14	12 - 14 (4.0 - 2.0)	.113 - .176 (2.87 - 4.47)	.225 - .275 (5.72 - 6.99)	30 (134)	70 (311)	25
12	1060-12-02**	1062-12-02**	10 - 12	10 - 12 (6.0 - 4.0)	.140 - .204 (3.56 - 5.18)	.225 - .275 (5.72 - 6.99)	30 (134)	70 (311)	25

\*\* For proper dies and stamped & formed crimp dimensions - See Envelope 0425-208-0000 12 Size Consult factory for alternate finishes

0425-203-0000 16 Size  
0425-207-0000 20 Size  
0425-059-0000 16,20 Size  
0425-039-0000 16 Size  
0425-041-0000 12 Size





**Contact Retention System (DTHD)**

Required Removal Tool (See page 12)

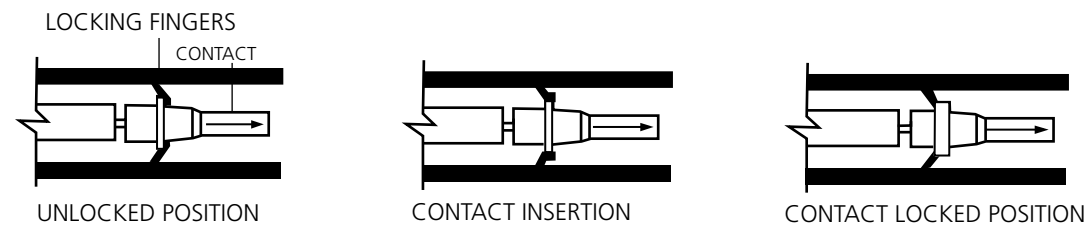

**Contact Insertion Procedure**

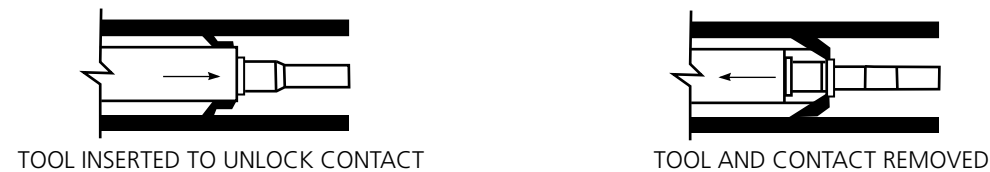

**Contact Insertion System (DTM/DT/DTP)**

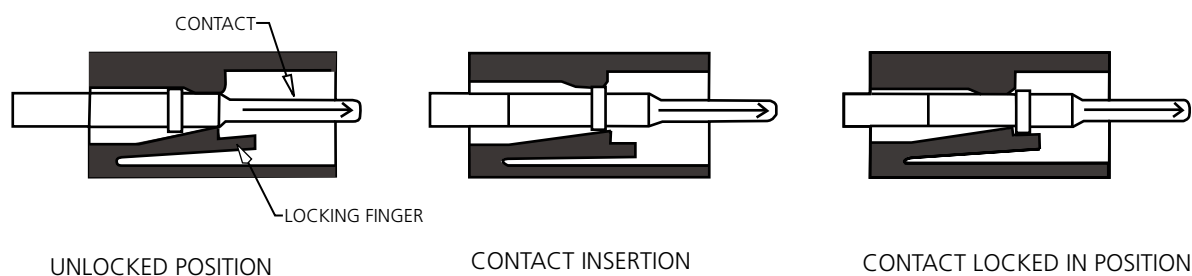

**Contact Removal Procedure (DTM/DT/DTP)**

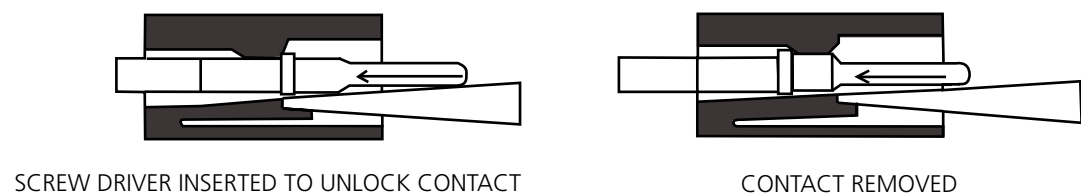

**Assembly Contact Insertion (DTM, DT, DTP)**

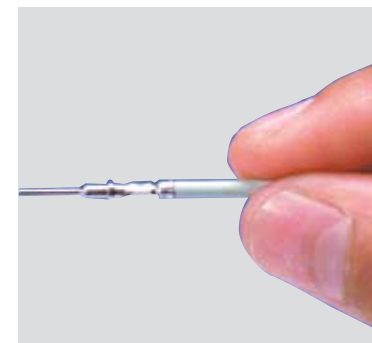

1. Grasp crimped contact approximately 1.0" (25.4mm) behind the contact barrel.

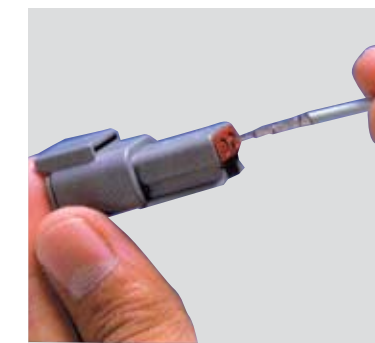

2. Hold connector with rear grommet facing you.

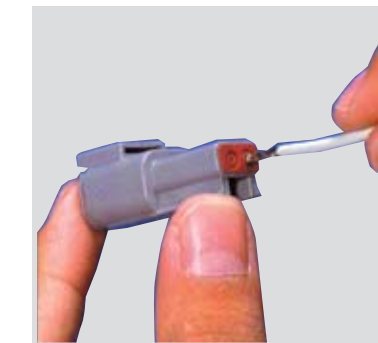

3. Push contact straight into connector grommet until a click is felt. A slight tug will confirm that it is properly locked in place.

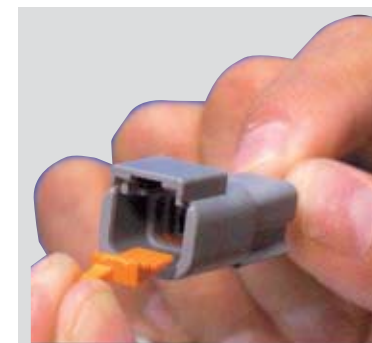

4. Once all contacts are in place, insert orange wedge: receptacles - with half holes aligning with contacts. Plugs - with contacts aligning behind full holes. The orange wedge will snap into place.

NOTE: The receptacle is shown - use the same procedure for plug.

**Contact Removal**



1. Remove orange wedge using needle-nose pliers to pull wedge straight out.

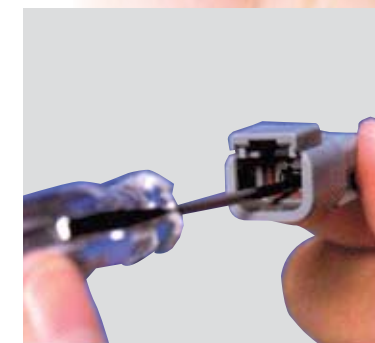

2. To remove the contacts, gently pull wire backwards, while at the same time releasing the locking finger by moving it away from the contact with a screwdriver.



3. Hold the rear seal in place, as removing the contact will displace the seal.

Accessories



To meet the application requirements where wires are to be protected, the DT Series may be supplied with boot adaptors. These will accept shaped boots / sleeves or shrink tubing. Parts for standard or thin wall wire are available.

Shrink Boot Adaptor Modification Numbers

Part Number - Plugs

Part Number - Receptacles

Number of Ways	Basic Part Number	Grey		Black		Number of Ways	Basic Part Number	Grey		Black	
		Std.	Thin Wall	Std.	Thin Wall			Std.	Thin Wall	Std.	Thin Wall
2	DT06-2S	-E008	-CE04	-EP11	-CE13	2	DT04-2P	-E008	-CE04	-EE11	-CE09
3	DT06-3S	-E008	-CE04	-EP11	-CE13	3	DT04-3P	-E008	-CE04	-EE11	-CE09
4	DT06-4S	-E008	-CE04	-EP11	-CE13	4	DT04-4P	-E008	-CE04	-EE11	-CE09
6	DT06-6S	-E008	-CE04	-EP11	-CE13	6	DT06-6P	-E008	-CE04	-EE11	-CE09
8	DT06-8SA	-E008	-CE04	-EP11	-CD13	8	DT04-8PA	-E008	-CE04	-EE11	-CE09
12	DT06-12SA	-E008	-CE04	-EP11	-CD13	12	DT04-12PA	-E008	-CE04	-EE11	-CE09

DTHD Removal Tools

Sealing Plugs

NORMAL WIRE SEALS (N)			EXTRA THIN WALL WIRE SEALS (E)			SEALING PLUG	
PART NO.	SIZE	WIRE RANGE AWG	PART NO.	SIZE	WIRE RANGE AWG	CONTACT SIZE	PART NO.
114010	12	12-14	0411-337-1205	12	12-14	20	0413-204-2005
114008	8	8-10	0411-353-0805	8	8-10	16-12	114017
114009	4	6	114009	4	6	8	114018
						4	114019

Wire Sealing Range: **Standard** - 2.24mm - 3.68mm wire insulation diameter **Thin wall** - 1.35mm - 3.05mm wire insulation diameter

DT Mounting Clips

Metal Mounting Clips



1027-001-0800

1027-003-1200

1027-004-1200



1027-005-1200



1027-014-0800

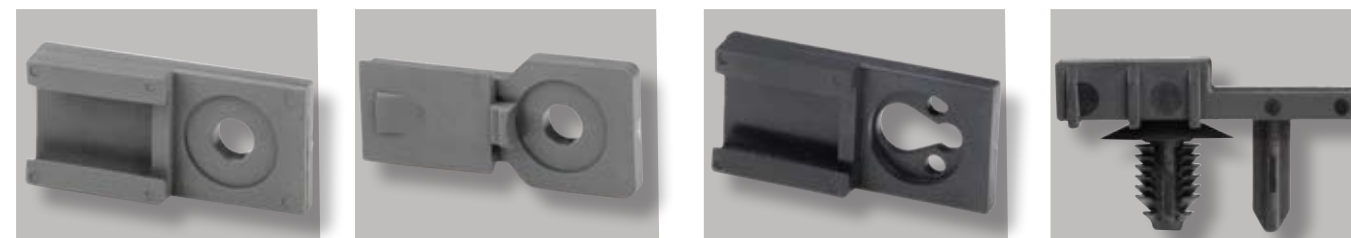

1011-026-0205 (Thru Hole)

1011-027-0805 (Thru Hole)

1011-030-0205 (Snap Fit)

1011-310-0205 (W/Self Mounting Stud)

Metal Mounting Clips

Plastic Mounting Clips

Part Number	Used On	Material	Hole O.D. in. (mm)	Part Number	Used On	Material	Color
1027-003-1200	DTM (all) DT 2, 3, 4, 6, 12 DTP (all) DTHD (all)	Stainless Steel	.433 (11.0)	1011-026-0205	DTM (all) DT 2, 3, 4, 6, 12 DTP (all) DTHD (all)	Plastic	Gray
1027-005-1200	DTM (all) DT 2, 3, 4, 6, 12 DTP (all) DTHD (all)	Stainless Steel	.512 (13.0)	1011-027-0805	DT 8 Cavity Only	Plastic	Gray
1027-004-1200	DTM (all) DT 2, 3, 4, 6, 12 DTP (all) DTHD (all)	Stainless Steel w/Zinc Plating	.512 (13.0)	1011-027-0805	DTM (all) DT 2, 3, 4, 6, 12 DTP (all) DTHD (all)	Plastic	Black
1027-001-0800	DT 8 cavity only	Stainless Steel	.433 (11.0)				
1027-014-0800	DT 8 cavity only	Stainless Steel w/Zinc Plating	.323 (8.2)				