

Artikel Nr.: 872629

Netzgerät, FLAT, CV, UT12V/6W



IP20 CE

Elektrische Daten

Betriebsart	spannungskonstant	Eingangsspannung	220-240V AC/50-60Hz
Leistung	6,00 W	Leistungsfaktor	0,50C
Ausgangsspannung	12V DC	Anschlußmöglichkeit	offene Kabel
Ausgangsstrom	0-500 mA		

Produkteigenschaften

	Schutzklasse II		Überspannungsschutz
SELV	Schutzkleinspannung		Lampenbetriebsgerät 110
	Kurzschlußfest		Möbeleinbau geeignet
	Überlastschutz	ErP	Standby-Stromverbrauch < 0,5 W
	Übertemperaturschutz	LVD	Sicherheit nach EN 61347
	Sicherheitstrafo	EMC	Funkentstörung + Störfestigkeit nach EN 55015 + EN 61547
	nicht dimmbar	EMC	Netzstromoberwellen + Flicker nach EN 61000-3-2 + EN 61000-3-3

Schwarze Felder sind zutreffend / graue Felder sind nicht zutreffend

Artikel Nr.: 872629

Netzgerät, FLAT, CV, UT12V/6W

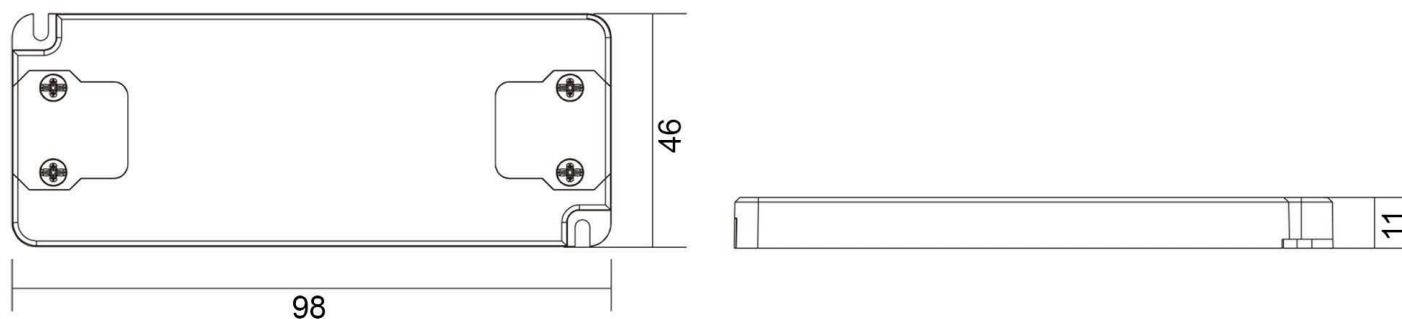
**Abmessungen und Gewicht****Grenzwerte**

Länge	98,00 mm	Betriebstemperatur	-20°C - +50°C
Breite	46,00 mm	Gehäusetemperatur	80 °C
Höhe	11,00 mm	max. Menge Sicherungsautomaten	B10A=17, B16A=28, C10A=37, C16A=59
Durchmesser	0,00 mm	max. Einschaltstrom	7A/300µs
Gewicht	42 g	kapazitive Last	38,83nF

Article No.: 872629

Power supply unit, FLAT, CV, UT12V/6W



IP20 CE

Electrical Characteristics

Operating mode	constant voltage	Input voltage	220-240V AC/50-60Hz
Power	6,00 W	Power factor	0,50C
Output voltage	12V DC	Connection possibility	wire with open ends
Output current	0-500 mA		

Product features

	Protection class II		Overvoltage protection
SELV	Low voltage protection		Lamp control gear 110
	Short circuit protection		Suitable for furniture installation
	Overload protection	ErP	Standby-power consumption < 0,5 W
	Overheating protection	LVD	Safety according to EN 61347
	Safety transformer	EMC	Interference suppression + immunity according to EN 55015 + EN 61547
	not dimmable	EMC	Mains harmonics + flicker according to EN 61000-3-2 + EN 61000-3-3

Black fields are applicable / gray fields are not applicable

Article No.: 872629

Power supply unit, FLAT, CV, UT12V/6W

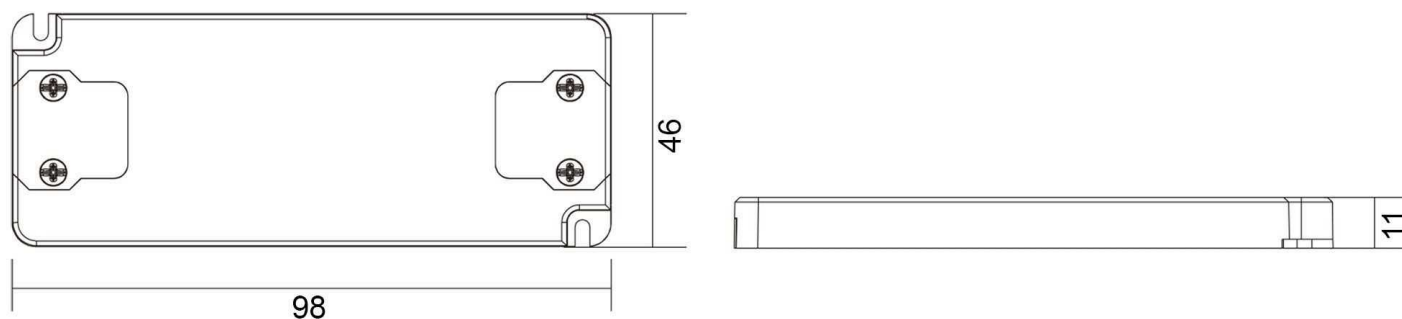
**Dimensions & Weight****Absolute maximum ratings**

Length	98,00 mm	Operating temperature	-20°C - +50°C
Width	46,00 mm	Case temperature	80 °C
Height	11,00 mm	max. amount of circuit breakers	B10A=17, B16A=28, C10A=37, C16A=59
Diameter	0,00 mm	max. inrush current	7A/300µs
Product weight	42 g	capacitive load	38,83nF