

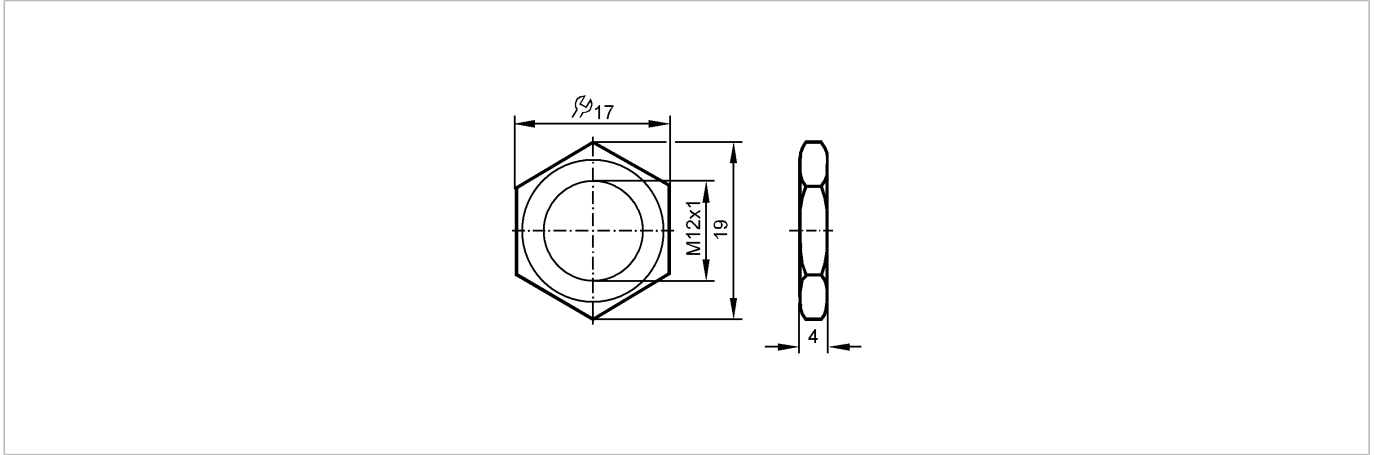

NUT M12 CUZN 10PCS.

Accessories



Product characteristics

Lock nuts metal

M12 x 1

Mechanical data

Housing materials

Brass nickel-plated

Weight

[kg]

0.079

Remarks

Pack quantity

[piece]

10