

# E43342

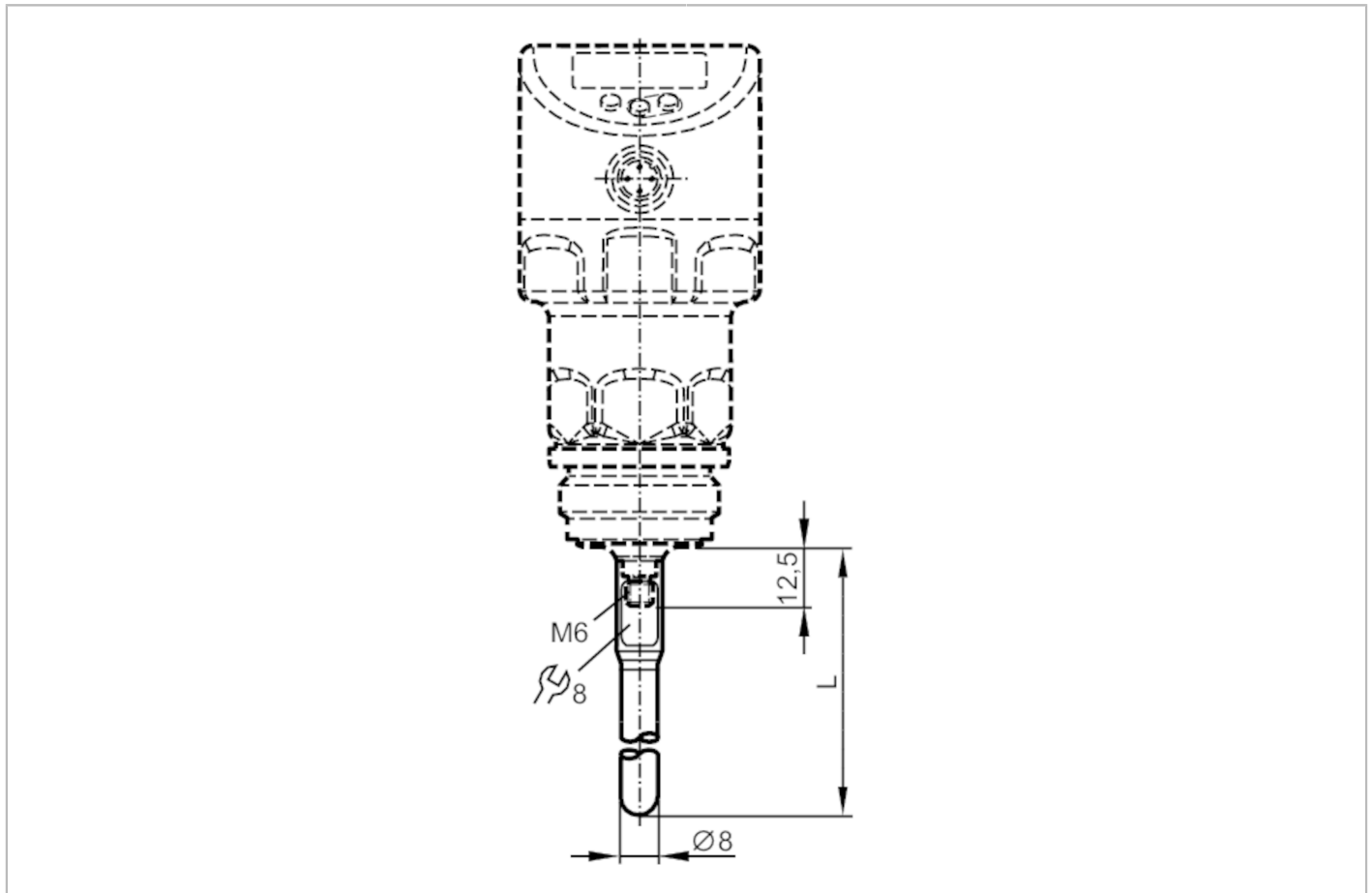

## Probe for level sensors

LR HYGIENE PROBE L2000



EC 1935/2004 EHEDG Certified FCM FDA

Application	
Design	hygienic, for level sensors LR
Application	hygienic systems
Measuring/setting range	
Probe length L [mm]	2000
Mechanical data	
Weight [g]	858.4
Materials	stainless steel (1.4404 / 316L)
Tightening torque [Nm]	< 6.5
Surface characteristics Ra/Rz of the wetted parts	< 0.8 / 8
Hygienic equipment class to DIN 11866	H3
Remarks	
Pack quantity	1 pcs.