



Part no.: 50134374
PRK15.D/2X-M12
Polarized retro-reflective photoelectric sensor



Figure can vary

Contents

- Technical data
- Dimensioned drawings
- Electrical connection
- Diagrams
- Operation and display
- Reflectors & reflective tapes
- Part number code
- Notes
- Accessories

Technical data

| Basic data | |
|---------------------|--------------------------------------|
| Series | 15 |
| Operating principle | Reflection principle |
| Application | Detection of stretch-wrapped objects |

| Optical data | |
|--------------------------|--|
| Operating range | Guaranteed operating range |
| Operating range | 0 ... 6 m , With reflector TK(S) 100x100 |
| Operating range limit | Typical operating range |
| Operating range limit | 0 ... 8 m , With reflector TK(S) 100x100 |
| Light source | LED , Red |
| LED light wavelength | 640 nm |
| Transmitted-signal shape | Pulsed |
| LED group | Exempt group (in acc. with EN 62471) |

| Electrical data | |
|------------------------|---|
| Protective circuit | Polarity reversal protection Short circuit protected |

| Performance data | |
|-------------------------|--|
| Supply voltage U_B | 10 ... 30 V , DC , Incl. residual ripple |
| Residual ripple | 0 ... 15 % , From U_B |
| Open-circuit current | 0 ... 20 mA |

| Outputs | |
|-------------------------------------|------------|
| Number of digital switching outputs | 1 Piece(s) |

| Switching outputs | |
|--------------------------|--|
| Voltage type | DC |
| Switching current, max. | 100 mA |
| Switching voltage | high: $\geq(U_B-2.5V)$ low: $\leq 2.5V$ |

| Switching output 1 | |
|---------------------------|---------------------|
| Assignment | Connection 1, pin 4 |
| Switching element | Transistor , NPN |
| Switching principle | Light switching |

| Timing | |
|---------------------|--------|
| Switching frequency | 500 Hz |
| Response time | 1 ms |
| Readiness delay | 300 ms |

| Connection | |
|---------------------|------------------------------|
| Connection 1 | |
| Type of connection | Connector |
| Function | Signal OUT Voltage supply |
| Thread size | M12 |
| Type | Male |
| Material | Plastic |
| No. of pins | 4 -pin |
| Encoding | A-coded |

Part no.: 50134374 – PRK15.D/2X-M12 – Polarized retro-reflective photoelectric

Mechanical data

| | |
|-----------------------|---|
| Dimension (W x H x L) | 15 mm x 42.7 mm x 30 mm |
| Housing material | Plastic , ABS |
| Lens cover material | Plastic |
| Net weight | 15 g |
| Housing color | Black |
| Type of fastening | Through-hole mounting Via optional mounting device |

Operation and display

| | |
|-----------------|------------|
| Type of display | LED |
| Number of LEDs | 2 Piece(s) |

Environmental data

| | |
|--------------------------------|---------------|
| Ambient temperature, operation | -40 ... 60 °C |
| Ambient temperature, storage | -40 ... 70 °C |

Certifications

| | |
|----------------------|---------------|
| Degree of protection | IP 67 |
| Protection class | III |
| Certifications | c UL US |
| Standards applied | IEC 60947-5-2 |

Classification

| | |
|-----------------------|----------|
| Customs tariff number | 85365019 |
| eCl@ss 8.0 | 27270902 |
| eCl@ss 9.0 | 27270902 |
| ETIM 5.0 | EC002717 |
| ETIM 6.0 | EC002717 |

Dimensioned drawings

All dimensions in millimeters

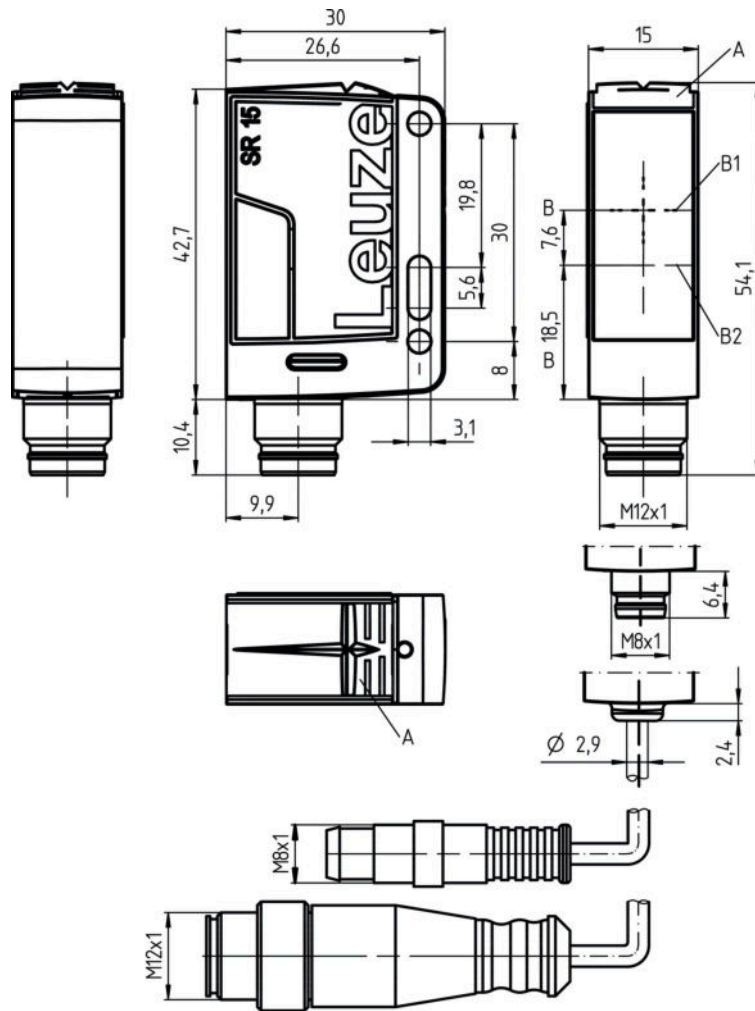

- A LED indicator
- B Optical axis
- B1 Receiver
- B2 Transmitter

Electrical connection

| Connection 1 | |
|--------------------|------------------------------|
| Type of connection | Connector |
| Function | Signal OUT Voltage supply |
| Thread size | M12 |
| Type | Male |
| Material | Plastic |
| No. of pins | 4 -pin |
| Encoding | A-coded |

| Pin | Pin assignment |
|-----|----------------|
| 1 | V+ |
| 2 | n.c. |
| 3 | GND |
| 4 | OUT 1 |

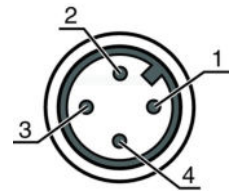

Diagrams

Typ. function reserve

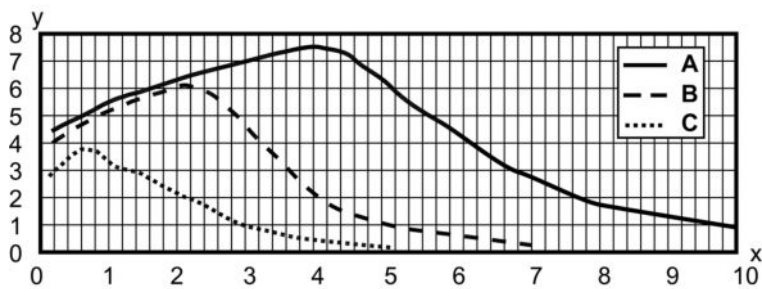

x Distance [m]
y Function reserve
A TKS 100x100
B TKS 40x60
C TKS 20x40

Typ. response behavior (TKS100x100)

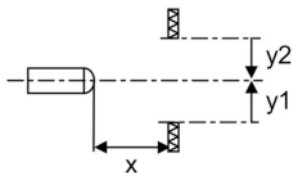
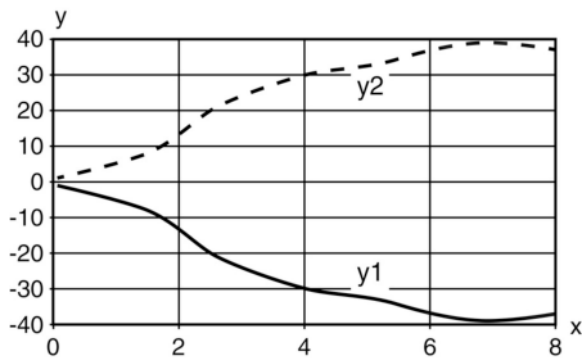

x Distance [m]
y Misalignment [mm]

Operation and display

LEDs

| LED | Display | Meaning |
|-----|--------------------------|--------------------------------------|
| 1 | Green, continuous light | Operational readiness |
| 2 | Yellow, continuous light | Light path free |
| | Yellow, flashing | Light path free, no function reserve |

Reflectors & reflective tapes

| | Part no. | Designation | Operating range/ Operating range limit | Description |
|---|----------|---------------|---|--|
|  | 50117583 | MTKS 50x50.1 | 0.3 ... 3.5 m 0.22 ... 4 m | Design: Rectangular Reflective surface: 50 mm x 50 mm Triple reflector size: 1.2 mm Material: Plastic Base material: Plastic Chemical designation of the material: PMMA8N Fastening: Through-hole mounting, Adhesive |
|  | 50110192 | REF 6-A-50x50 | 0.13 ... 2.5 m 0.1 ... 3 m | Design: Rectangular Reflective surface: 50 mm x 50 mm Triple reflector size: 0.3 mm Material: Plastic Chemical designation of the material: PMMA Fastening: Self-adhesive |
|  | 50003192 | TK 100x100 | 0.07 ... 6 m 0.05 ... 8 m | Design: Rectangular Reflective surface: 96 mm x 96 mm Triple reflector size: 4 mm Material: Plastic Base material: Plastic Chemical designation of the material: PMMA8N Fastening: Adhesive |
|  | 50022816 | TKS 100X100 | 0.07 ... 6 m 0.05 ... 8 m | Design: Rectangular Reflective surface: 96 mm x 96 mm Triple reflector size: 4 mm Material: Plastic Base material: Plastic Chemical designation of the material: PMMA8N Fastening: Through-hole mounting, Adhesive |
|  | 50081283 | TKS 20X40 | 0.12 ... 2 m 0.08 ... 3 m | Design: Rectangular Reflective surface: 16 mm x 38 mm Triple reflector size: 2.3 mm Material: Plastic Base material: Plastic Chemical designation of the material: PMMA8N Fastening: Through-hole mounting, Adhesive |
|  | 50040820 | TKS 40X60 | 0.08 ... 3 m 0.06 ... 4 m | Design: Rectangular Reflective surface: 37 mm x 56 mm Triple reflector size: 4 mm Material: Plastic Base material: Plastic Chemical designation of the material: PMMA8N Fastening: Through-hole mounting, Adhesive |

Part no.: 50134374 – PRK15.D/2X-M12 – Polarized retro-reflective photoelectric

Part number code

Part designation: AAA15d.EE/ ff-HH

| | |
|-------|---|
| AAA15 | Operating principle / construction: HT15: diffuse reflection sensor with background suppression PRK15: retro-reflective photoelectric sensor with polarization filter LS15: throughbeam photoelectric sensor transmitter LE15: throughbeam photoelectric sensor receiver |
| d | Light type: n/a: red light l: infrared light |
| EE | Equipment: 1: adjustable range D: detection of stretch-wrapped objects |
| ff | Switching output / function / OUT1OUT2 (OUT1 = pin 4, OUT2 = pin 2): 2: NPN transistor output, light switching N: NPN transistor output, dark switching 4: PNP transistor output, light switching P: PNP transistor output, dark switching X: pin not used |
| HH | Electrical connection: n/a: cable, standard length 2000 mm, 4-wire M8: M8 connector, 4-pin (plug) 200-M12: cable, length 200 mm with M12 connector, 4-pin, axial (plug) M12: M12 connector, 4-pin (plug) |

Note

A list with all available device types can be found on the Leuze electronic website at www.leuze.com.

Notes

Observe intended use!

- This product is not a safety sensor and is not intended as personnel protection.
- The product may only be put into operation by competent persons.
- Only use the product in accordance with its intended use.

For UL applications:



- Only for use in "class 2" circuits
- These proximity switches shall be used with UL Listed Cable assemblies rated 30V, 0.5A min, in the field installation, or equivalent (categories: CYJV/CYJV7 or PVVA/PVVA7)

- Light source: Average life expectancy 100,000 h at an ambient temperature of 25 °C

Part no.: 50134374 – PRK15.D/2X-M12 – Polarized retro-reflective photoelectric

Accessories



Connection technology - Connection cables

| | Part no. | Designation | Article | Description |
|---|----------|--------------------|------------------|--|
|  | 50130652 | KD U-M12-4A-V1-050 | Connection cable | Connection 1: Connector, M12, Axial, Female, A-coded, 4 -pin Connection 2: Open end Shielded: No Cable length: 5,000 mm Sheathing material: PVC |
|  | 50130690 | KD U-M12-4W-V1-050 | Connection cable | Connection 1: Connector, M12, Angled, Female, A-coded, 4 -pin Connection 2: Open end Shielded: No Cable length: 5,000 mm Sheathing material: PVC |

Mounting technology - Mounting brackets

| | Part no. | Designation | Article | Description |
|--|----------|-------------|-----------------|--|
|  | 50040269 | BT 25 | Mounting device | Design of mounting device: Angle, L-shape Fastening, at system: Through-hole mounting Mounting bracket, at device: Screw type Type of mounting device: Rigid Material: Metal |

Mounting technology - Rod mounts

| | Part no. | Designation | Article | Description |
|---|----------|--------------|-----------------|---|
|  | 50117829 | BTP 200M-D12 | Mounting system | Design of mounting device: Protection hood Fastening, at system: For 12 mm rod Mounting bracket, at device: Screw type Type of mounting device: Clampable, Adjustable, Turning, 360° Material: Metal |
|  | 50117255 | BTU 200M-D12 | Mounting system | Contains: 2x M3 x 16 screw, 2 M3 x 20 screws, 2x position washers Design of mounting device: Mounting system Fastening, at system: For 12 mm rod, Sheet-metal mounting Mounting bracket, at device: Screw type, Suited for M3 screws Type of mounting device: Clampable, Adjustable, Turning, 360° Material: Metal |

Standard reflectors

| | Part no. | Designation | Article | Description |
|---|----------|-------------|-----------|--|
|  | 50081283 | TKS 20X40 | Reflector | Design: Rectangular Reflective surface: 16 mm x 38 mm Triple reflector size: 2.3 mm Material: Plastic Base material: Plastic Chemical designation of the material: PMMA8N Fastening: Through-hole mounting, Adhesive |

Part no.: 50134374 – PRK15.D/2X-M12 – Polarized retro-reflective photoelectric

| | Part no. | Designation | Article | Description |
|---|----------|-------------|-----------|--|
|  | 50040820 | TKS 40X60 | Reflector | Design: Rectangular Reflective surface: 37 mm x 56 mm Triple reflector size: 4 mm Material: Plastic Base material: Plastic Chemical designation of the material: PMMA8N Fastening: Through-hole mounting, Adhesive |

Reflective tapes for standard applications

| | Part no. | Designation | Article | Description |
|---|----------|---------------|-----------------|---|
|  | 50108300 | REF 4-A-50x50 | Reflective tape | Design: Rectangular Reflective surface: 50 mm x 50 mm Material: Plastic Chemical designation of the material: PMMA Fastening: Self-adhesive |

Note

A list with all available accessories can be found on the Leuze electronic website in the Download tab of the article detailed page.