



SWITCH-DISCONNECTOR 125A, FRAME SIZE 2, 3-POLE FRONT OPERATING CENTER BASIC UNIT WITHOUT HANDLE BOX TERMINAL

Model		
product brand name		SENTRON
Product designation		Switching device
<b>Design of the product</b>		3KD switch disconnectors
<b>Design of the operating mechanism</b>		without
<b>Design of handle</b>		without
<b>Type of the driving mechanism / motor drive</b>		No
General technical data		
<b>Number of poles</b>		3
<b>Type of device</b>		fixed mounting
<b>circuit-breaker / Design</b>		3KD3
<b>Mechanical service life (switching cycles) / typical</b>		15 000
<b>Overvoltage category</b>		III
Voltage		
Insulation voltage / Rated value	V	1 000
Surge voltage resistance / Rated value	kV	8
Protection class		
<b>Protection class IP</b>		IP20
Protection class IP / on the front		IP20
Dissipation		
<b>Active power loss</b>		
<ul style="list-style-type: none"> <li>with conventional rated thermal current / per pole</li> </ul>	W	4.5

## Electricity

<b>Continuous current</b>		
• Rated value	A	125
• at 40 °C / Rated value	A	125
• at 45 °C / Rated value	A	125
• at 50 °C / Rated value	A	125
• at 55 °C / Rated value	A	125
• at 60 °C / Rated value	A	125
• at 65 °C / Rated value	A	125
• at 70 °C / Rated value	A	125
Short-time current resistance (I <sub>cw</sub> ) / limited to 1 s / Rated value	kA	4

## Main circuit

<b>Operating power</b>		
• at AC-23 A / at 400 V / at 50/60 Hz / Rated value	kW	55
• at AC-23 A / at 500 V / at 50/60 Hz / Rated value	kW	75
• at AC-23 A / at 690 V / at 50/60 Hz / Rated value	kW	110
<b>Operating voltage</b>		
• with AC / at 50/60 Hz / Rated value	V	690

## Auxiliary circuit

Number of CO contacts / for auxiliary contacts		4
Number of NC contacts / for auxiliary contacts		0
Number of NO contacts / for auxiliary contacts		0

## Suitability

<b>Suitability for use</b>		
• Main switch		Yes
• switch disconnecter		Yes
• EMERGENCY OFF switch		No
• safety switch		Yes
• maintenance/repair switch		Yes

## Product details

Product feature / interlock		No
<b>Product component</b>		
• Trip indicator		No
• Voltage trigger		No
• undervoltage release		No
• undervoltage release with leading contact		No
<b>Product expansion</b>		

• Auxiliary switch	Yes
• optional	
— motor drive	No
— Voltage trigger	No

### Connections

#### Type of electrical connection

• for main current circuit	Box terminal
----------------------------	--------------

### Mechanical Design

Height	mm	126
Width	mm	121
Depth	mm	68
mounting position		any
Mounting type		Floor mounting and snap-on mounting to 35 mm standard mounting rail
Mounting type		
• front mounting with 4-hole attachment		No
• front mounting with central attachment		No
• rail mounting		Yes

### Environmental conditions

#### Ambient temperature

• during operation / minimum	°C	-25
• during operation / maximum	°C	70
• during storage / minimum	°C	-50
• during storage / maximum	°C	80

### Certificates

Equipment marking / acc. to DIN EN 61346-2

Q

#### General Product Approval

#### Declaration of Conformity



### Further information

**Information- and Downloadcenter (Catalogs, Brochures,...)**

<http://www.siemens.com/lowvoltage/catalogs>

**Industry Mall (Online ordering system)**

<https://eb.automation.siemens.com/mall/en/WW/Catalog/Product/3KD32302NE200>

**Service&Support (Manuals, Certificates, Characteristics, FAQs,...)**

<http://support.automation.siemens.com/WW/view/en/3KD32302NE200/all>

**Image database (product images, 2D dimension drawings, 3D models, device circuit diagrams, ...)**

[http://www.automation.siemens.com/bilddb/cax\\_en.aspx?mlfb=3KD32302NE200](http://www.automation.siemens.com/bilddb/cax_en.aspx?mlfb=3KD32302NE200)

**CAX-Online-Generator**

<http://www.siemens.com/cax>

**Tender specifications**

<http://ausschreibungstexte.siemens.com/tiplv>

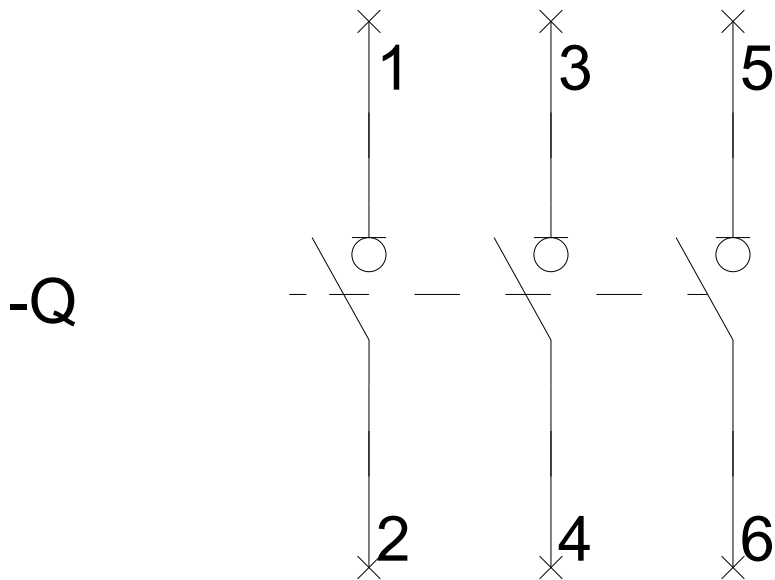
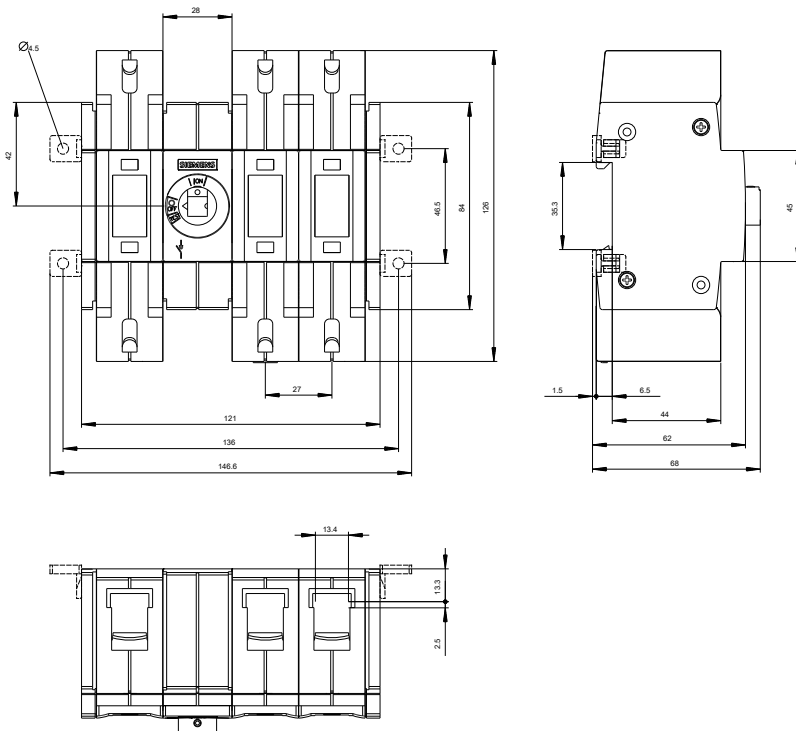

**last modified:**

11.03.2015