

FEATURES

- It is extremely compact at approx. 2/3 the size of previous products.**
 Compared to our previous miniature type CT relay, both the 1 Form C and 10-pin and 8-pin twin types take up approx. two-thirds the space and volume. This makes them ideal for relay unit miniaturization.
- Compact and high-capacity 25 A load switching**
 High capacity control is possible while being compact and capable of motor lock load switching at 25 A, 14 V DC.
- Pin in Paste* compatible model added**
 Models compatible with the recently increasing Pin in Paste technique (reflow solder mounting) have been added.
 Pin in Paste compatible models are the flux tight type.
 * The Pin in Paste method may sometimes be referred to as THR (Through-hole Reflow).
- Environmental protection specifications**
 Cadmium-free contacts and use of lead-free solder are standard. Environmental pollutants are not used.

TYPICAL APPLICATIONS

- Powered windows
- Automatic door locks
- Electrically powered mirrors
- Powered sunroofs
- Powered seats
- Lift gates
- Smart J/B related products, etc.

ORDERING INFORMATION

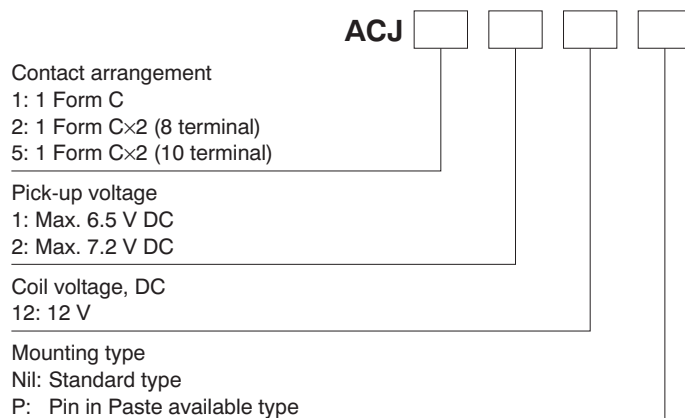

TYPES

Contact arrangement	Nominal coil voltage	Pick-up voltage (at 20°C 68°F)	Part No.	
			Standard type	Pin in Paste type
1 Form C	12 V DC	Max.6.5 V DC (Initial)	ACJ1112	ACJ1112P
		Max.7.2 V DC (Initial)	ACJ1212	ACJ1212P
1 Form C × 2 (8 terminal)		Max.6.5 V DC (Initial)	ACJ2112	ACJ2112P
		Max.7.2 V DC (Initial)	ACJ2212	ACJ2212P
1 Form C × 2 (10 terminal)		Max.6.5 V DC (Initial)	ACJ5112	ACJ5112P
		Max.7.2 V DC (Initial)	ACJ5212	ACJ5212P

Standard packing; Carton (tube): 70 pcs.; Case: 2,800 pcs. (1 Form C), Carton (tube): 40 pcs.; Case: 1,000 pcs. (8 terminal),
 Carton (tube): 35 pcs.; Case: 1,400 pcs. (10 terminal)

CJ (ACJ)

RATING

1. Coil data

Nominal coil voltage	Pick-up voltage (at 20°C 68°F)	Drop-out voltage (at 20°C 68°F)	Nominal operating current [$\pm 10\%$] (at 20°C 68°F)	Coil resistance [$\pm 10\%$] (at 20°C 68°F)	Nominal operating power (at 20°C 68°F)	Usable voltage range*
12 V DC	Max. 7.2 V DC (Initial)	Min. 1.0 V DC (Initial)	53.3 mA	225 Ω	640 mW	10 to 16 V DC
	Max. 6.5 V DC (Initial)	Min. 0.8 V DC (Initial)	66.7 mA	180 Ω	800 mW	9 to 16 V DC

* Other usable voltage range types are also available. Please contact us for details.

2. Specifications

Characteristics	Item	Specifications	
Contact	Arrangement	1 Form C, 1 Form C \times 2	
	Contact resistance (Initial)	N.O.: Typ7m Ω , N.C.: Typ10m Ω (By voltage drop 6 V DC 1 A)	
	Contact material	Ag alloy (Cadmium free)	
Protective construction		Standard type: Sealed type Pin in Paste type: Flux tight type	
Rating	Nominal switching capacity (resistive load)	N.O.: 20A 14V DC, N.C.: 10A 14V DC	
	Max. carrying current (14V DC)	N.O.: 20 A for 1 hour, 30 A for 2 minutes (at 20°C 68°F) (when coil powered on one side)	
	Nominal operating power	640 mW (for pick-up voltage max. 7.2 V DC), 800 mW (for pick-up voltage max. 6.5 V DC)	
	Min. switching capacity (resistive load)*1	1A 14V DC	
Electrical characteristics	Initial insulation resistance		Min. 100 M Ω (at 500V DC, Measurement at same location as "Breakdown voltage" section.)
	Breakdown voltage (Initial)	Between open contacts	500 Vrms for 1 min. (Detection current: 10mA)
		Between contacts and coil	500 Vrms for 1 min. (Detection current: 10mA)
	Operate time (at nominal voltage)		Max. 10ms (at 20°C 68°F, excluding contact bounce time) (Initial)
	Release time (at nominal voltage)		Max. 10ms (at 20°C 68°F, excluding contact bounce time) (Initial)
Mechanical characteristics	Shock resistance	Functional	Min. 100 m/s ² {10G} (Half-wave pulse of sine wave: 11ms; detection time: 10 μ s)
		Destructive	Min. 1,000 m/s ² {100G} (Half-wave pulse of sine wave: 6ms)
	Vibration resistance	Functional	10 Hz to 100 Hz, Min. 44.1m/s ² {4.5G} (Detection time: 10 μ s)
		Destructive	10 Hz to 500 Hz, Min. 44.1m/s ² {4.5G} Time of vibration for each direction; X, Y direction: 2 hours, Z direction: 4 hours
Expected life	Mechanical		Min. 10 ⁷ (at 120 cpm)
	Electrical		[Standard type] <Resistive load> Min. 10 ⁵ (at nominal switching capacity, operating frequency: 1s ON, 9s OFF) <Motor load> N.O. side: Min. 2 \times 10 ⁵ : at 25 A (inrush), 5 A (steady), 14 V DC; Min. 10 ⁵ : at 25 A 14 V DC (Motor lock) N.C. side: Min. 2 \times 10 ⁵ : at 20 A 14 V DC (brake) (Operating frequency: 0.5s ON, 9.5s OFF) [Pin in Paste type] <Resistive load> Min. 10 ⁵ (at nominal switching capacity, operating frequency: 1s ON, 9s OFF) <Motor load> N.O. side: Min. 10 ⁵ : at 25 A (inrush), 5 A (steady), 14 V DC; Min. 5 \times 10 ⁴ : at 25 A 14 V DC (Motor lock) N.C. side: Min. 10 ⁵ : at 20 A 14 V DC (brake) (Operating frequency: 0.5s ON, 9.5s OFF)
Conditions	Conditions for operation, transport and storage*2		Ambient temperature: -40°C to +85°C -40°F to +185°F Humidity: 5% R.H. to 85% R.H. (Not freezing and condensing at low temperature)
	Max. operating speed		6 cpm (at nominal switching capacity)
Mass			1 Form C type: approx. 3.5 g .12 oz, Twin type: approx. 6.5 g .23 oz

Notes:

*1. This value can change due to the switching frequency, environmental conditions, and desired reliability level, therefore it is recommended to check this with the actual load.

*2. The upper operation ambient temperature limit is the maximum temperature that can satisfy the coil temperature rise value. Refer to "6. Usage, Storage and Transport Conditions" in [AMBIENT ENVIRONMENT section in Relay Technical Information](#).

Please inquire if you will be using the relay in a high temperature atmosphere (110°C 230°F).

*3. Depends on connection conditions. Also, this does not guarantee repeated switching. We recommend that you confirm operation under actual conditions.

* If the relay is used continuously for long periods of time with coils on both sides in an energized condition, breakdown might occur due to abnormal heating depending on the carrying condition. Therefore, please inquire when using with a circuit that causes an energized condition on both sides simultaneously.

REFERENCE DATA

1.-(1) Coil temperature rise (at room temperature)

Sample: ACJ1212, 3pcs
 Measured portion: Inside the coil
 Contact carrying current: 10A, 15A, 20A
 Ambient temperature: 25°C 77°F

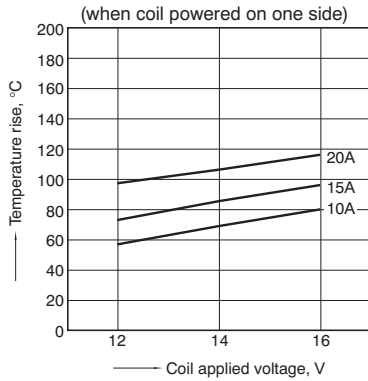

1.-(2) Coil temperature rise (at 85°C 185°F)

Sample: ACJ1212, 3pcs
 Measured portion: Inside the coil
 Contact carrying current: 10A, 15A, 20A
 Ambient temperature: 85°C 185°F

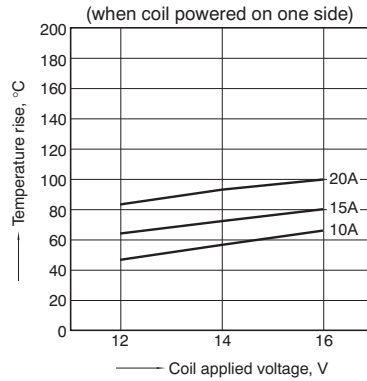

1.-(3) Coil temperature rise (at room temperature)

Sample: ACJ2212, 3pcs
 Measured portion: Inside the coil
 Contact carrying current: 10A, 15A, 20A
 Ambient temperature: 25°C 77°F

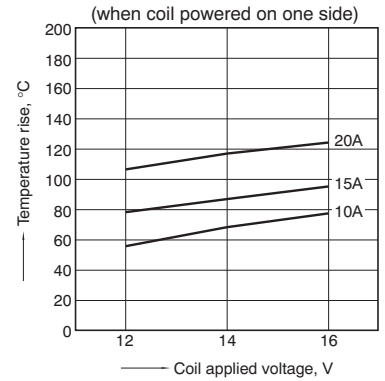

1.-(4) Coil temperature rise (at 85°C 185°F)

Sample: ACJ2212, 3pcs
 Measured portion: Inside the coil
 Contact carrying current: 10A, 15A, 20A
 Ambient temperature: 85°C 185°F

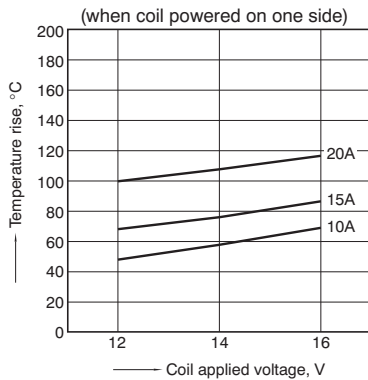

1.-(5) Coil temperature rise (at room temperature)

Sample: ACJ5212, 3pcs
 Measured portion: Inside the coil
 Contact carrying current: 10A, 15A, 20A
 Ambient temperature: 25°C 77°F

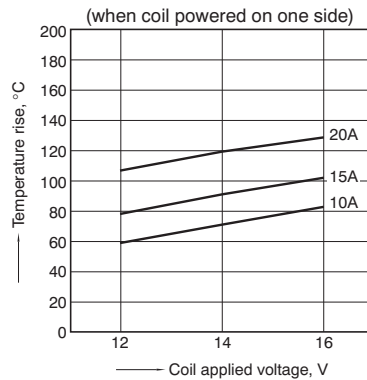

1.-(6) Coil temperature rise (at 85°C 185°F)

Sample: ACJ5212, 3pcs
 Measured portion: Inside the coil
 Contact carrying current: 10A, 15A, 20A
 Ambient temperature: 85°C 185°F

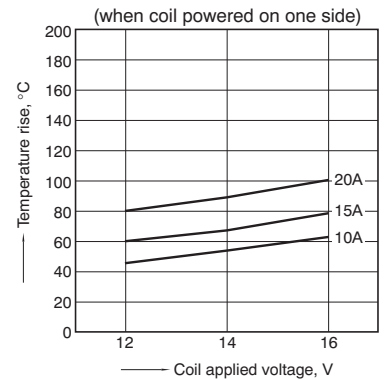

2.-(1) Ambient temperature and operating voltage range

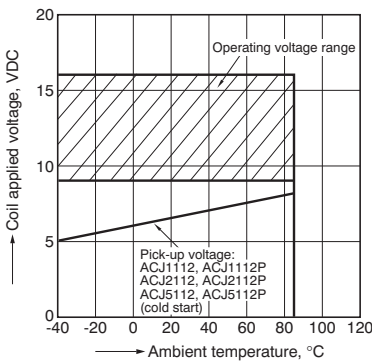

2.-(2) Ambient temperature and operating voltage range

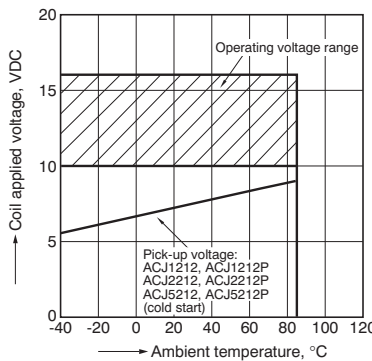

3.-(1) Distribution of pick-up and drop-out voltage

Sample: ACJ2112, 50pcs
 Ambient temperature: Room temperature

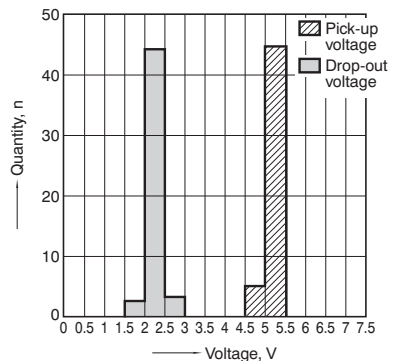

CJ (ACJ)

3.-(2) Distribution of pick-up and drop-out voltage

Sample: ACJ2212, 50pcs.

Ambient temperature: Room temperature

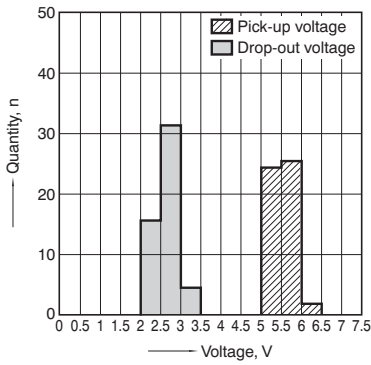

4.-(1) Distribution of operate and release time

Sample: ACJ2112, 50pcs.

Ambient temperature: Room temperature

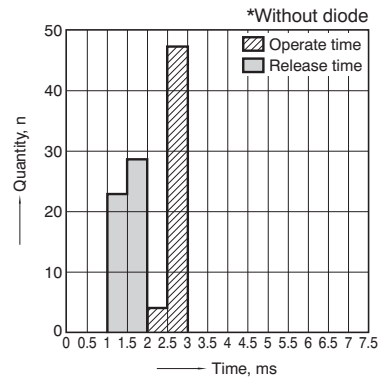

4.-(2) Distribution of operate and release time

Sample: ACJ2212, 50pcs.

Ambient temperature: Room temperature

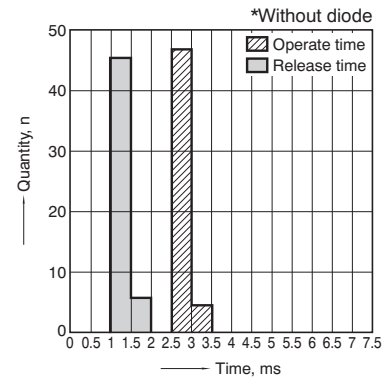

5.-(1) Electrical life test (Motor free)

Sample: ACJ2212, 3pcs

Load: Inrush current: 25A/Steady current: 5A,

Power window motor actual load (free condition)

Tested voltage: 14V DC

Switching frequency: ON 0.5s, OFF 9.5s

Switching cycle: 2×10^5

Ambient temperature: Room temperature

Circuit

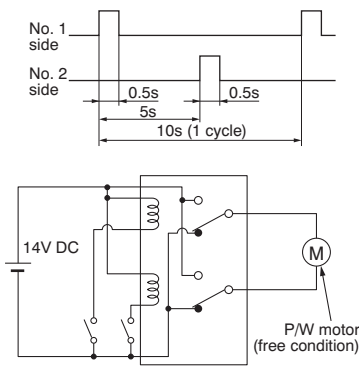

Change of pick-up and drop-out voltage

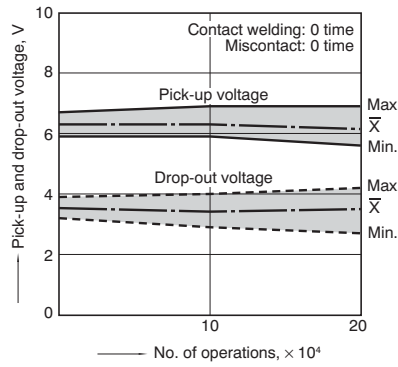

Change of contact resistance

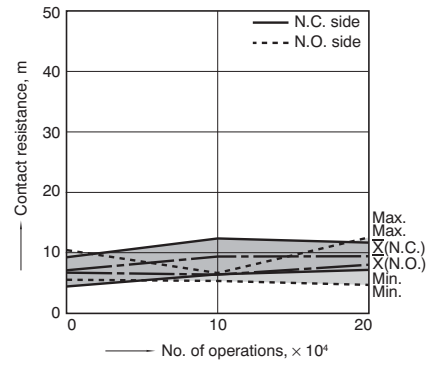

Load current waveform

Inrush current: 25A, Steady current: 6A,

Brake current: 13A

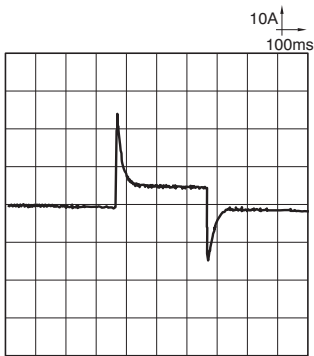

5.-(2) Electrical life test (Motor lock)

Sample: ACJ2212, 3pcs
 Load: Steady current: 25A, Power window motor actual load (lock condition)
 Tested voltage: 14V DC
 Switching frequency: ON 0.5s, OFF 9.5s
 Switching cycle: 10^s
 Ambient temperature: Room temperature
 Circuit

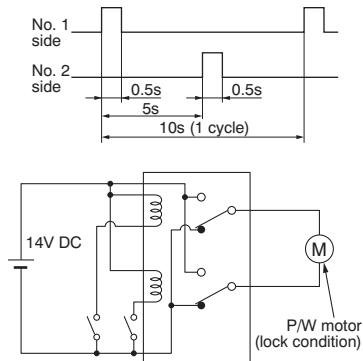

Load current waveform
 Current value: 25A

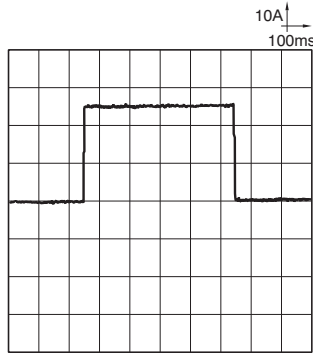

Change of pick-up and drop-out voltage

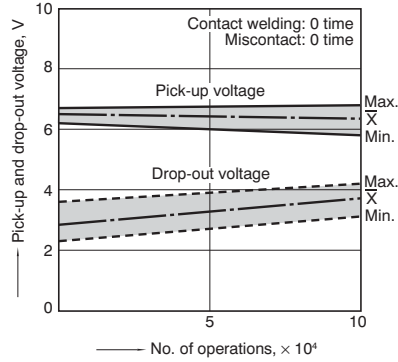

Change of contact resistance

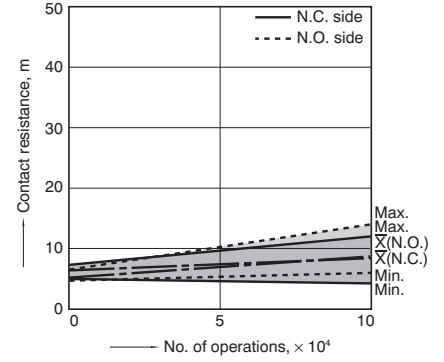

DIMENSIONS (mm inch)

Download [CAD Data](#) from our Web site.

1. Twin type (8-pin)

[CAD Data](#)



External dimensions

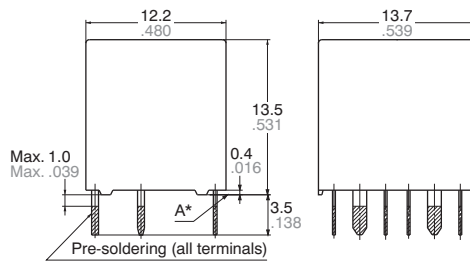

PC board pattern (Bottom view)

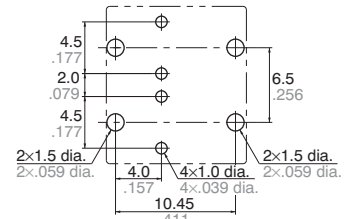

Tolerance: ±0.1 ±.004

Schematic (Bottom view)

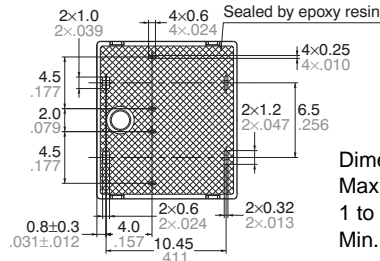
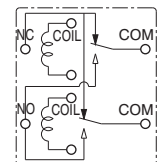

Dimension:
 Max. 1mm .039 inch:
 1 to 3mm .039 to .118 inch:
 Min. 3mm .118 inch:

Tolerance
 ±0.1 ±.004
 ±0.2 ±.008
 ±0.3 ±.012

* Dimensions (thickness and width) of terminal is measured before pre-soldering.
 Intervals between terminals is measured at A surface level.

CJ (ACJ)

2. Twin type (8-pin) Pin in Paste type

[CAD Data](#)



External dimensions

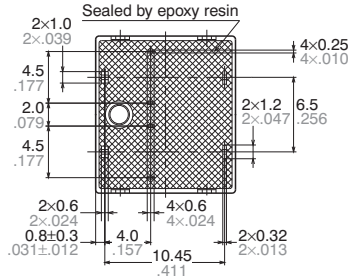
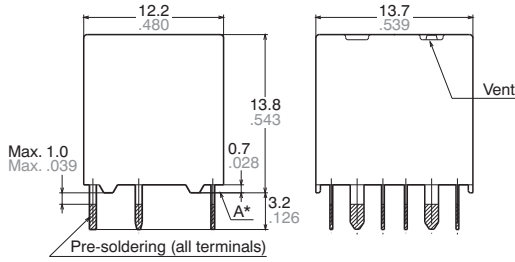

Dimension:
Max. 1mm .039 inch: $\pm 0.1 \pm 0.004$
1 to 3mm .039 to .118 inch: $\pm 0.2 \pm 0.008$
Min. 3mm .118 inch: $\pm 0.3 \pm 0.012$

PC board pattern (Bottom view)

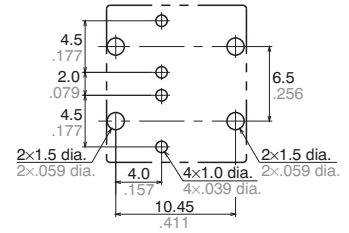

Tolerance: $\pm 0.1 \pm 0.004$

Schematic (Bottom view)

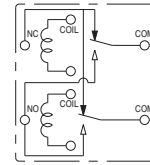

* Dimensions (thickness and width) of terminal is measured before pre-soldering.
Intervals between terminals is measured at A surface level.

3. Twin type (10-pin) Standard type

[CAD Data](#)



External dimensions

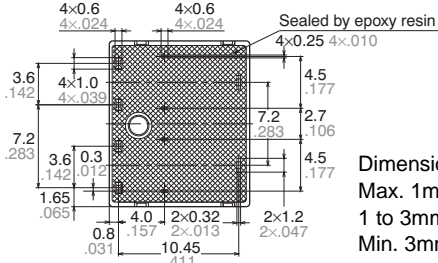
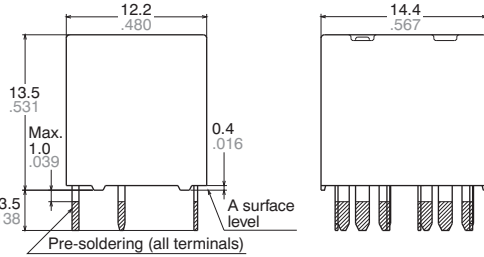

Dimension:
Max. 1mm .039 inch: $\pm 0.1 \pm 0.004$
1 to 3mm .039 to .118 inch: $\pm 0.2 \pm 0.008$
Min. 3mm .118 inch: $\pm 0.3 \pm 0.012$

PC board pattern (Bottom view)

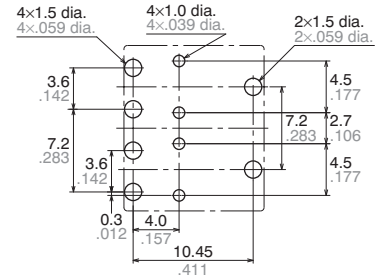

Tolerance: $\pm 0.1 \pm 0.004$

Schematic (Bottom view)

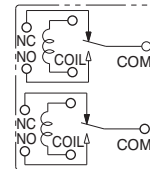

* Dimensions (thickness and width) of terminal is measured before pre-soldering.
Intervals between terminals is measured at A surface level.

4. Twin type (10-pin) Pin in Paste type

[CAD Data](#)



External dimensions

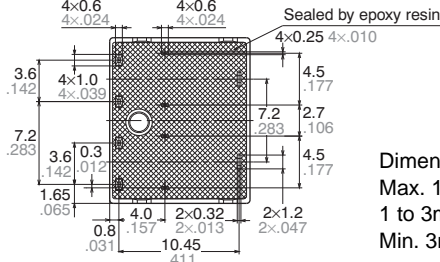
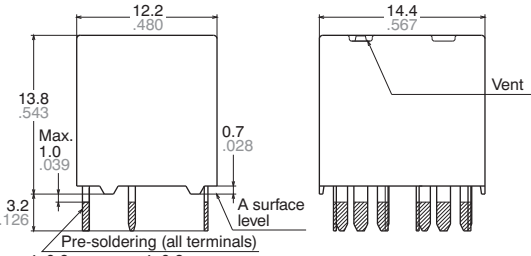

Dimension:
Max. 1mm .039 inch: $\pm 0.1 \pm 0.004$
1 to 3mm .039 to .118 inch: $\pm 0.2 \pm 0.008$
Min. 3mm .118 inch: $\pm 0.3 \pm 0.012$

PC board pattern (Bottom view)

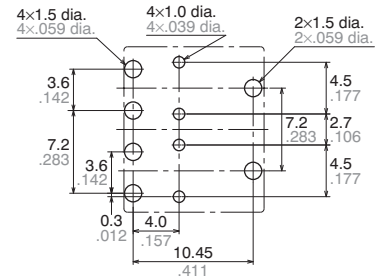

Tolerance: $\pm 0.1 \pm 0.004$

Schematic (Bottom view)

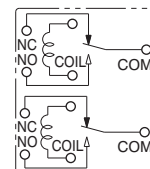

* Dimensions (thickness and width) of terminal is measured before pre-soldering.
Intervals between terminals is measured at A surface level.

**5. Slim 1 Form C
Standard type**

CAD Data



External dimensions

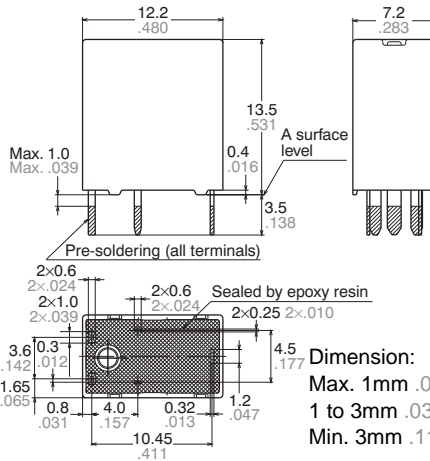

Dimension:
 Max. 1mm .039 inch: $\pm 0.1 \pm .004$
 1 to 3mm .039 to .118 inch: $\pm 0.2 \pm .008$
 Min. 3mm .118 inch: $\pm 0.3 \pm .012$

PC board pattern (Bottom view)

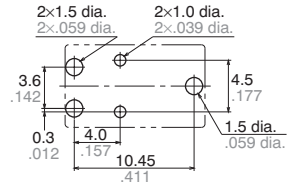

Tolerance: $\pm 0.1 \pm .004$

Schematic (Bottom view)

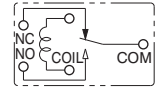

* Dimensions (thickness and width) of terminal is measured before pre-soldering.
 Intervals between terminals is measured at A surface level.

**6. Slim 1 Form C
Pin in Paste type**

CAD Data



External dimensions

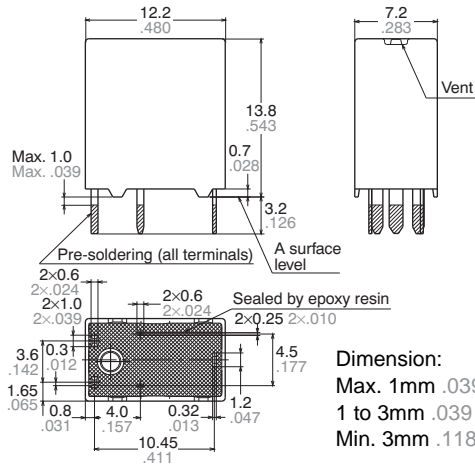

Dimension:
 Max. 1mm .039 inch: $\pm 0.1 \pm .004$
 1 to 3mm .039 to .118 inch: $\pm 0.2 \pm .008$
 Min. 3mm .118 inch: $\pm 0.3 \pm .012$

PC board pattern (Bottom view)

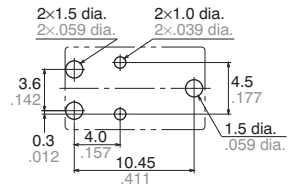

Tolerance: $\pm 0.1 \pm .004$

Schematic (Bottom view)

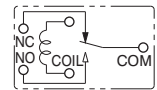

* Dimensions (thickness and width) of terminal is measured before pre-soldering.
 Intervals between terminals is measured at A surface level.

NOTES

Assembly and cleaning conditions for Pin-in-Paste type

1) Example of the recommended conditions for automated assembly is shown below.

• Temperature profile during reflow-soldering (Recommended)

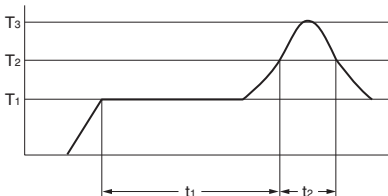

T₁ = 150 to 180°C 302 to 356°F
 T₂ = 230°C 446°F or more
 T₃ = Less than 260°C 500°F
 t₁ = 60 to 120 sec.
 t₂ = Less than 40 sec.

• Cautions for mounting
 Temperature rise of relay itself may vary according to the mounting level or the heating method of reflow equipment. Therefore, please set the temperature of soldering portion of relay terminal and the top surface of the relay case not to exceed the above mentioned soldering condition. It is recommended to check the temperature rise of each portion under actual mounting condition before use.

2) Cleaning or coating should be avoided. Because "Pin-in-Paste" type is not a sealed type. Also, use caution for avoiding penetration of soldering flux into the interior of the relay.

CJ (ACJ)

EXAMPLE OF CIRCUIT

Forward/reverse control circuits of DC motor (for 1 Form C × 2 (8 terminal) type)

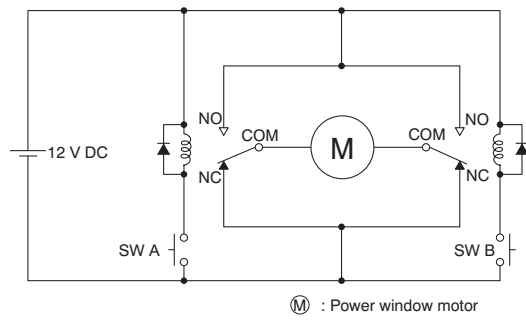

For Cautions for Use, see [Relay Technical Information](#).