

PCB Layout(Component side)

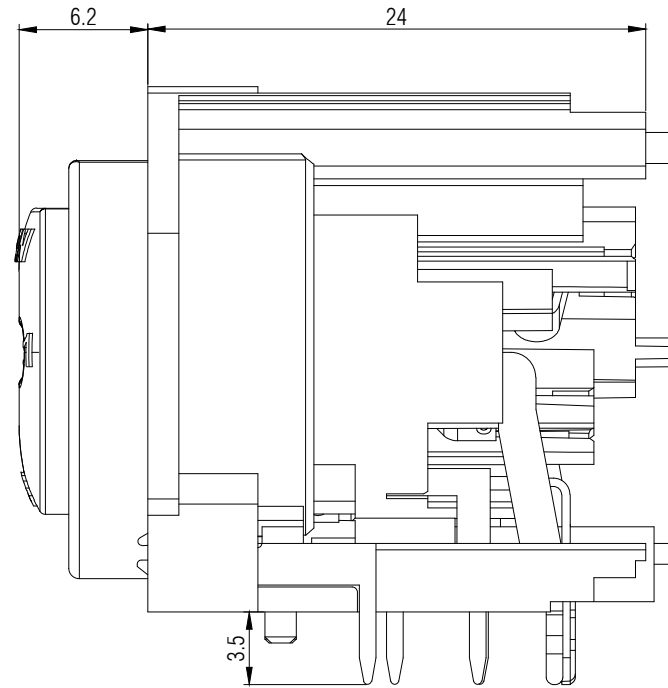

Panel cut out(Rear side)

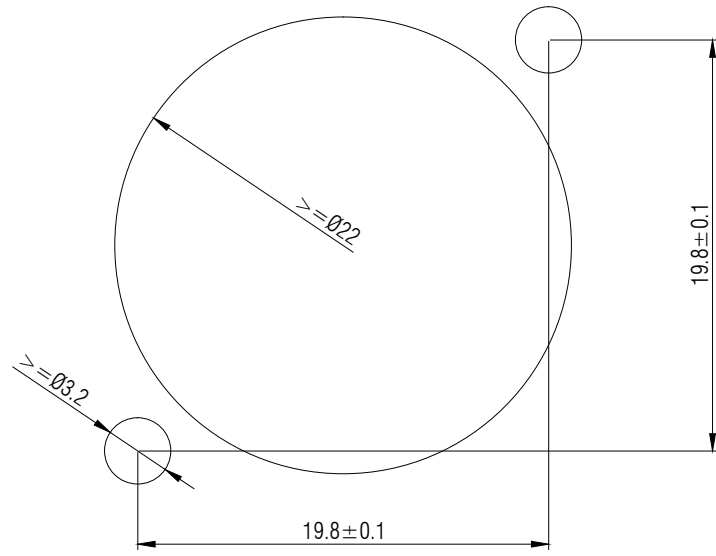
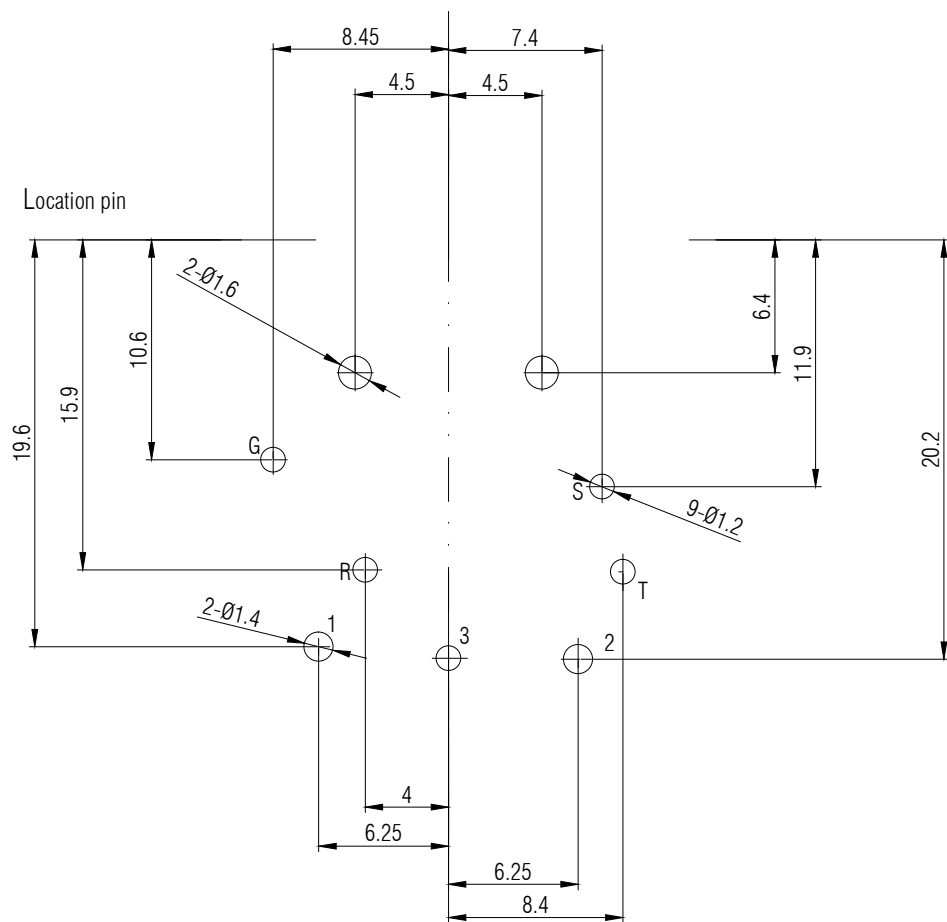
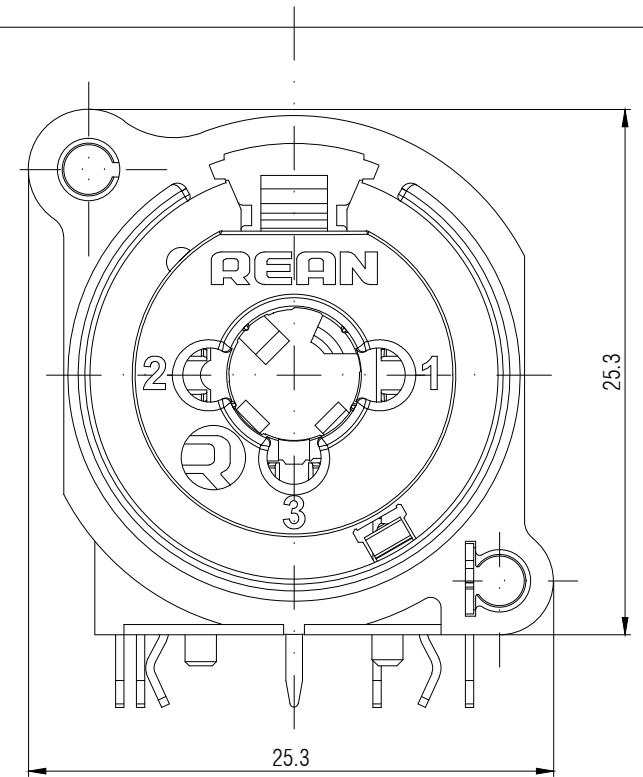

Normalling-Schemes

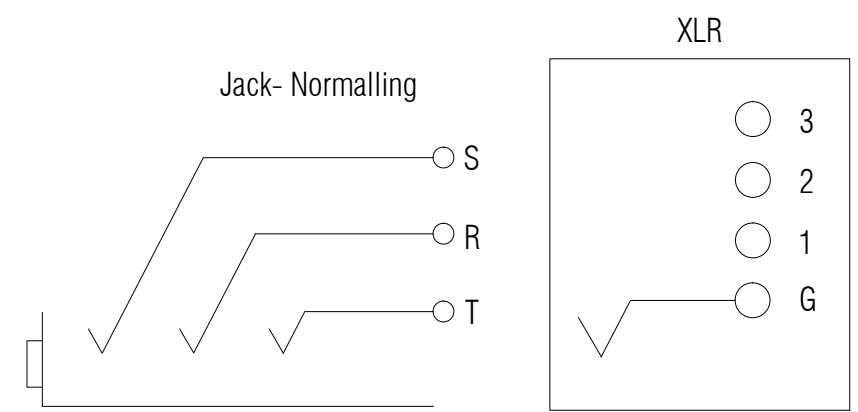

Note:

1. All dimensions in mm.
2. Tolerances not specified is  $\pm 0.20$ mm.

THIS DOCUMENT IS THE PROPERTY OF NEUTRIK. NO PART THEREOF MAY BE REPRODUCED AND USED WITHOUT THE PRIOR WRITTEN CONSENT OF THE OWNER				Material:	Scale:	Date:	Name:
					3 : 1 (A3)	2020.01.08	Jacky
Title: <b>RCJ6FA-H-0</b>				Checked:		2020.01.08	Abraham
				Approved:		Replaced By:	
Rev.				Revision Details		Date	Name
				Date		Replaces:	
REAN				Drawing No.:		3.664.034	
				Date		Name	