





FRONT BUS CONNECTORS 3 PCS. ACCESSORY FOR: 3VA6  
400/600



Model	
Product brand name	SETRON
Product designation	accessories
Connections according IEC	
Thickness / of the busbar / minimum	2 mm
Width / of the busbar / maximum	40 mm
Thickness / of the busbar / maximum	12.5 mm
Connections according UL	
Width / of the busbar / maximum	1.6 in
Thickness / of the busbar / minimum	0.08 in
Thickness / of the busbar / maximum	0.5 in
Certificates	

General Product Approval	EMC	Declaration of Conformity	other
 CSA	 UL		 RCM  EG-Konf. <a href="#">Miscellaneous</a>

#### Further information

**Information- and Downloadcenter (Catalogs, Brochures,...)**

<http://www.siemens.com/lowvoltage/catalogs>

**Industry Mall (Online ordering system)**

<https://mall.industry.siemens.com/mall/en/en/Catalog/product?mlfb=3VA9473-0QB00>

**Service&Support (Manuals, Certificates, Characteristics, FAQs,...)**

<https://support.industry.siemens.com/cs/ww/en/ps/3VA9473-0QB00>

**Image database (product images, 2D dimension drawings, 3D models, device circuit diagrams, ...)**

[http://www.automation.siemens.com/bilddb/cax\\_en.aspx?mlfb=3VA9473-0QB00](http://www.automation.siemens.com/bilddb/cax_en.aspx?mlfb=3VA9473-0QB00)

**CAX-Online-Generator**

<http://www.siemens.com/cax>

**Tender specifications**

<http://www.siemens.com/specifications>

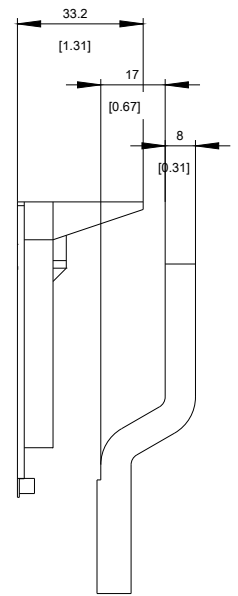
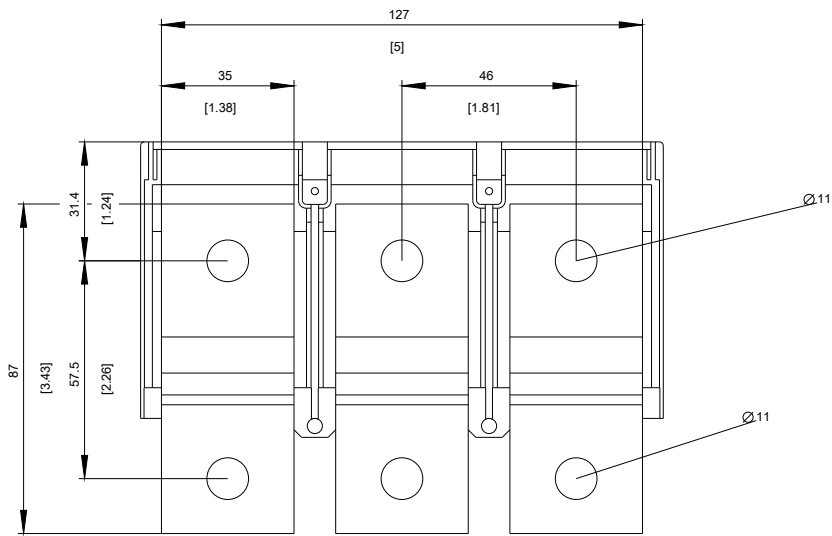

**last modified:**

08/28/2017