

Support Legs

22593.0080



Product Description

The support legs are universally usable as adjustable legs. The plate is screwed to the threaded pin and nut by a stainless steel fastening screw, and is also glued.

Material

Grub Screw

- Steel, zinc-plated by galvanization, passivated

Lock nut

- Steel, zinc-coated by galvanisation, passivated, ISO 4032

Pad

- Steel, zinc-plated by galvanization, passivated

More information

Further products

- Support Legs, protected against slipping

Drawing

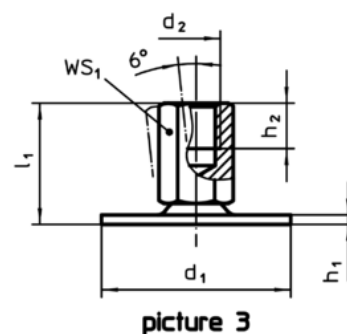
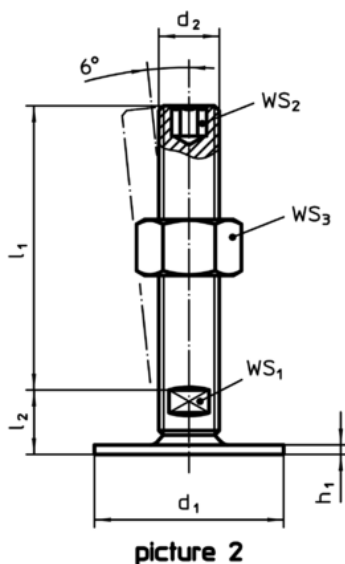
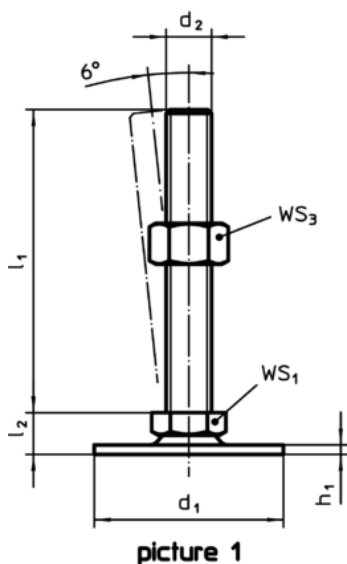

Order information

d ₁	d ₂	Dimensions			WS ₁ [mm]	WS ₃ [mm]	 [g]	Art. No.
		l ₁ [mm]	h ₁	l ₂				
with screw – picture 1, steel								
50	M10	60	2.5	11	17	16	86	22593.0080

Compliance

RoHS compliant

Contains lead - compliant according to exceptions 6a / 6b / 6c

Contains SVHC substances >0,1% w/w

Contains lead - SVHC list [REACH] as of 10.06.2022

Contains Proposition 65 substances



Lead can cause cancer and reproductive harm from exposure
<https://www.P65Warnings.ca.gov/>

Free from Conflict Minerals

This product does not contain any substances designated as "conflict minerals" such as tantalum, tin, gold or tungsten from the Democratic Republic of Congo or adjacent countries.