

1. Application

- ESD Protection

2. Features

- For 4lines
- IEC61000-4-2(ESD) $\pm 15\text{kV}$ (air), $\pm 10\text{kV}$ (contact)
- Low capacitance : 0.55pF typical
- Fast turn on and low clamping voltage
- RoHS regulation conformity parts

3. Mechanical details (dimensions : mm)

TOP VIEW

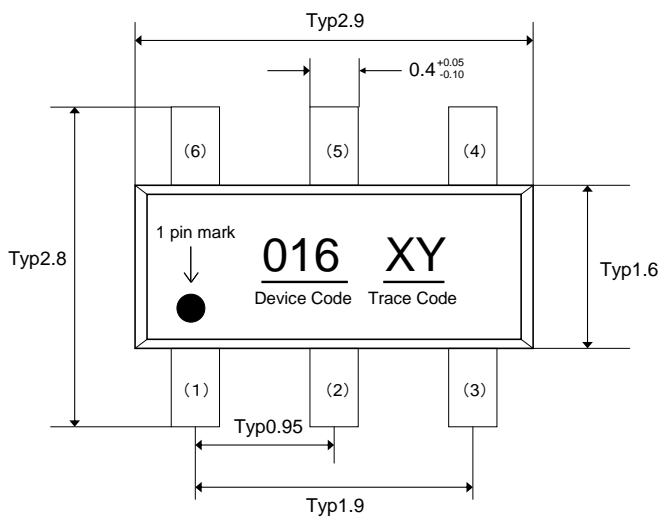

END VIEW

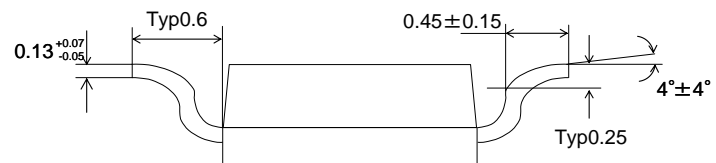

SIDE VIEW

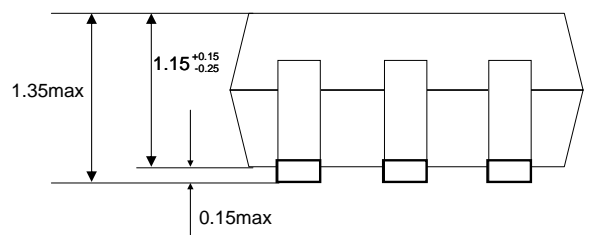

No.	Terminal name
1	I/O 1
2	GND
3	I/O 2
4	I/O 3
5	VDD
6	I/O 4

4. Schematic

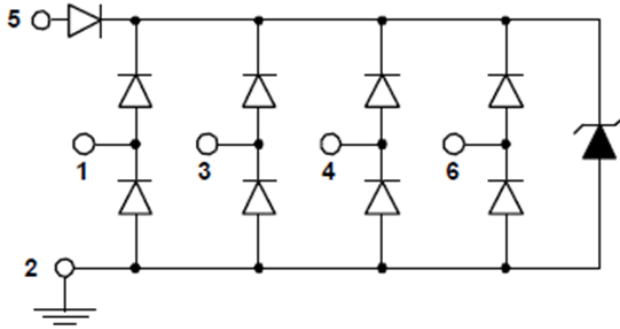

5. Maximum Ratings

Rating	Symbol	Value	Units
Operating voltage (VDD-GND)	V_{DC}	5.5	V
ESD per IEC 61000-4-2 (air)	V_{ESD}	±15	kV
ESD per IEC 61000-4-2 (contact)		±10	
Lead Soldering Temperature	T_{SOL}	260(10sec.)	°C
Operating Temperature	T_{OP}	-40 to +85	°C
Storage Temperature	T_{STO}	-40 to +125	°C

6. Electrical characteristics (T=25 °c)

Parameter	Symbol	Conditions	Min	Typ	Max	Units
Leakage current (I/O-GND)	I_{Leak}	$V_{pin5}=5V, V_{pin2}=0V, V_{CH}=0-5V$			1	μA
Breakdown Voltage	V_{BV}	$I_{BV} = 1mA$	6		9	V
Capacitance (I/O-GND)	C_{IN}	$V_{pin5}=5V, V_{pin2}=0V, V_{in}=2.5V, f=1MHz$		0.55		pF

7. Typical Characteristic

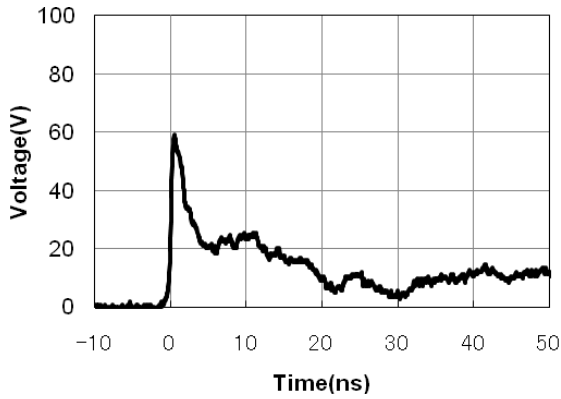

ESD Waveform (IEC61000-4-2:8kV Contact)

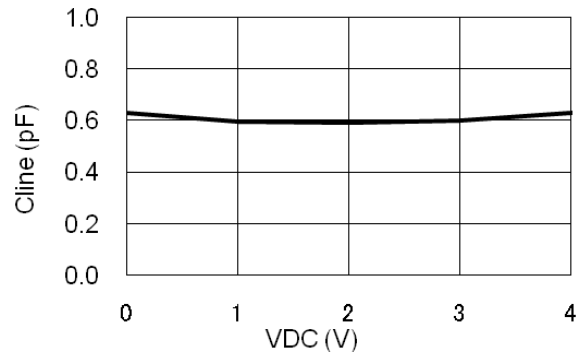

Voltage - Capacitance Characteristic

8. Soldering Footprint (dimensions : mm)

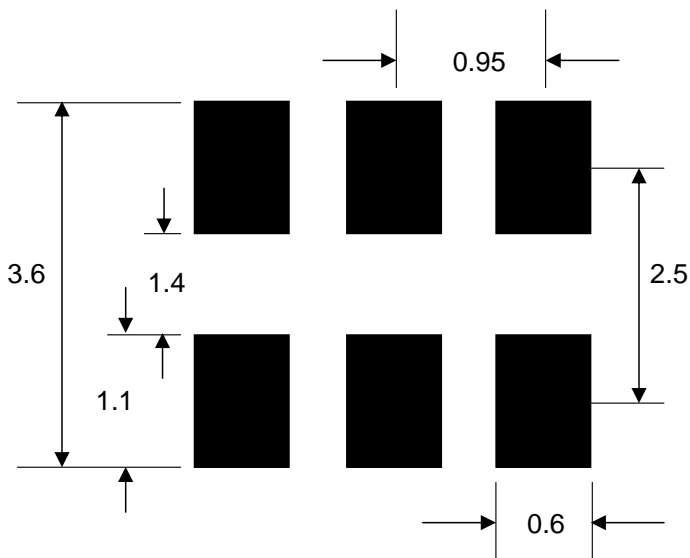

Notes: this land layout is for reference purpose only.

