

## MST 1-PHASE CONTROL AND ISOLATION TRANSFORMER

P: 1000VA IN: 208...550VAC OUT: 2x115VAC

Single-phase - Control and Isolation Transformers  
1000 VA  
Isolation class T 40/B

Other voltages on request.

### [Link to Product](#)

#### Illustration

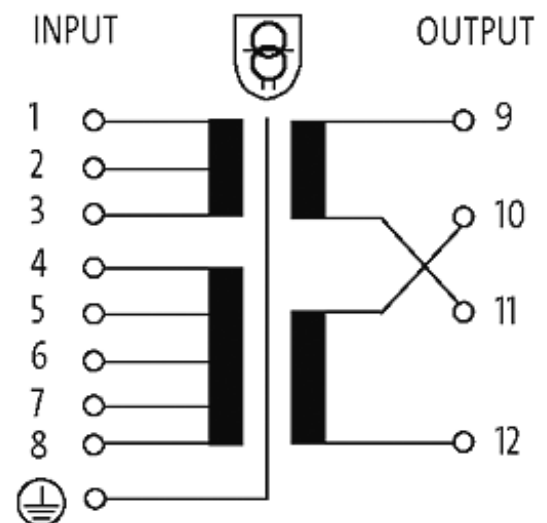

stay connected

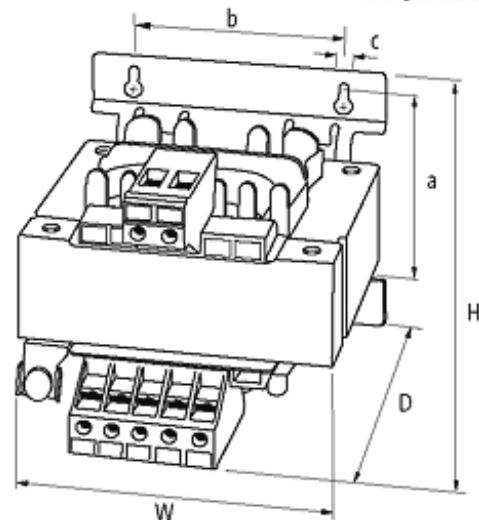

Product may differ from Image

### Approvals



### Input

Input voltage	208, 230, 380, 400, 420, 440, 460, 480, 500, 525, 550 V AC
Input current	4.73 A (230 V AC); 2.72 A (400 V AC)
Inrush current	66 A (230 V AC); 38 A (400 V AC)
Short-circuit current	148 A (230 V AC); 85 A (400 V AC)
Frequency	50...60 Hz

### General data

Standards	(EN 61558-1), (EN 61558-2-4), (EN 62041 category 0)
Test isolation voltage	4 kV (prim./sec.)
Mounting method	Key-hole mounting
Dimensions H × W × D	128×174×160 mm
Fixing centers a × b × c	102×135×7 mm
Drill hole Ø	7×11 mm
Temperature range	-20...+40 °C, no condensation

### Output

Output voltage	2 × 115 V AC/230 V AC
----------------	-----------------------

### Commercial data

country of origin	CZ
customs tariff number	85043180
minimum order quantity	1