

Actuator/sensor cable, PUR
Connection cable
RKS4.5T-5/TXL

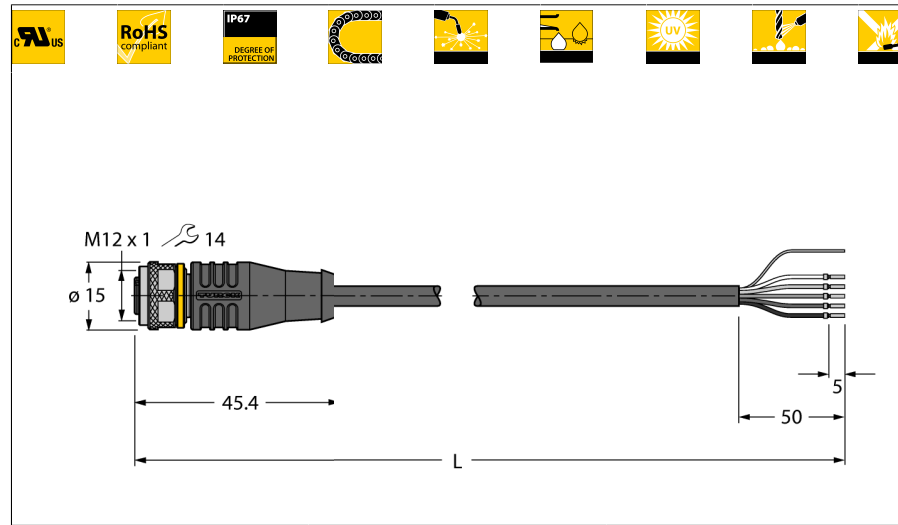

- Female M12, straight, 5-pin
- Shield on coupling nut/screw
- Sheath material: PUR, shielded
- Sheath color: black
- Qualified for drag chain use
- Resistant to weld splatter
- Resistant to chemicals, UV radiation and oils
- Flame retardant
- Free from halogen, silicone, PVC and LABS
- Particularly resistant to abrasion
- Approval: cULus
- RoHS conform
- Protection class IP67
- Cable length: 5.0 m

Type designation RKS4.5T-5/TXL
Ident no. 6626374

Connector A side Female connector, M12 ♂ 1, Straight
Number of pins 5
Contacts Brass, CuZn, Gold-plated
Contact carriers Plastic, TPU, Black
Grip Plastic, TPU, Black
Coupling nut/screw Brass, CuZn, Nickel-plated
Seal Plastic, FPM/FKM
Protection class IP67, A + B side screwed together
Mechanical lifespan > 100 Mating cycles
Pollution degree 3
Tightening torque 0.8 ... 1 Nm
 (observe max. torque of counter piece!)

Cable Cross-section

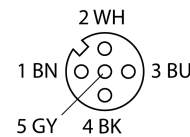
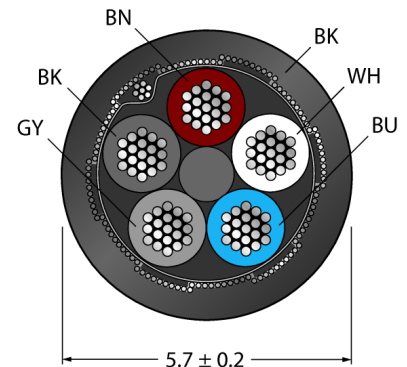

General data
Cable diameter 5.7 ± 0.20mm
Cable length 5 m
Cable quality PUR
Cable color Black
Core insulation PP
Core colors BN, WH, BU, BK, GY
Core cross-section 5x0.34mm²
Arrangement of strands 42x0.1 mm
Shielding Aluminum foil, tinned copper wire

Electrical features at +20 °C
Current 4 A
Rated voltage 60 V
Insulation resistance > 30.5 MΩ/km
Test voltage 2000 V
Forward resistance max. 57 Ω/km

Drawing shows design status including hexagon coupling nut
 (Start of production CW42/2016).

Circuit Diagram

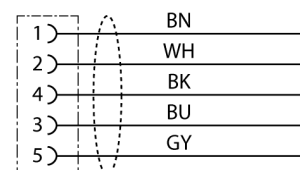

Actuator/sensor cable, PUR
Connection cable
RKS4.5T-5/TXL

TURCK





Industrial
Automation

Mechanical and chemical properties

Max. tensile strength (static)	≤ 50 N/mm ²
Max. tensile strength (dynamic)	≤ 20 N/mm ²
Bending cycles	> 2 mil.
Bending radius (stationary laying)	> 5 x Ø
Bending radius (flexible use)	> 10 x Ø
Admissible acceleration	max. 5 m/s ²
Admissible travel path, horizontal	5 m (at 5 m/s ²)
Admissible travel path, vertical	2 m (at 5 m/s ²)
Admissible traversing speed	3.3 m/s
Torsional stress	± 180 °/m
Ambient temperature	
Stationary	-50...+80°C
In motion	-25...+80°C
Drag chain operation	-25...+60°C

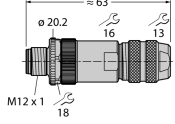
Actuator/sensor cable, PUR
Connection cable
RKS4.5T-5/TXL

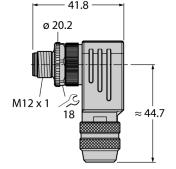
Accessories

Type code	Ident no.	Description	
CMBS8151-0	6930161	Field-wireable male connector, M12  , straight, 5-pin, screw terminal connection, cable feedthrough 6.0 to 8.0 mm, core cross-section/terminal capacity 0.14 to 0.75 mm ² , metal housing, metal nut, shieldable	
CMBS8251-0	6930216	Field-wireable male connector, M12  , angled, 5-pin, screw terminal connection, cable feedthrough 6.0 to 8.0 mm, core cross-section/terminal capacity 0.14 to 0.75 mm ² , metal housing, metal nut, shieldable	
Torque-Wrench-Set-AS	6936170	Torque wrench set; handles with adjustable torque 0.4-1.0 Nm, torque wrench for M8 (SW9), fork wrench for M12 (SW 14)	
BLANK-LABEL-FOR-CORDSETS-TEL-TXL	6936206	Label for TEL and TXL cables, length: 18 mm, height: 4 mm, material: polycarbonate (PC), color: white, halogen-free and flame-retardant	