

## Seating Pins · pin shape

22680.0484



### Product Description

To be used as solid and precise seat and stop. The pin-shaped form of this locating pin allows an application in components with narrow seating points. Bearing surface induction hardened and grounded.

### Material

- Heat-treated steel, tempered, blackened

### Drawing

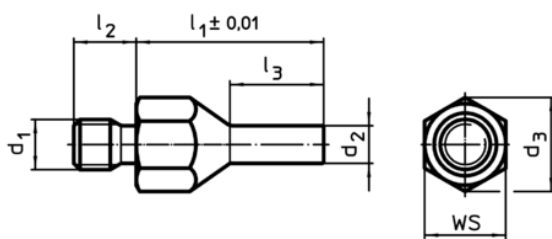

picture 1

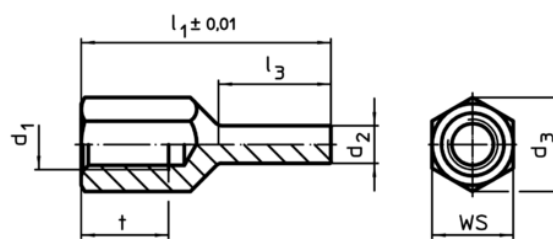

picture 2

### Order information

l <sub>1</sub> ±0.01	d <sub>1</sub>	Dimensions				d <sub>3</sub>	WS [mm]	Tightening torque max. [Nm]	g	Art. No.
		d <sub>2</sub>	l <sub>3</sub>	t	[mm]					
with female thread – picture 2										
60	M12	6	28	18	21.2	19	60	56	22680.0484	

### Application example

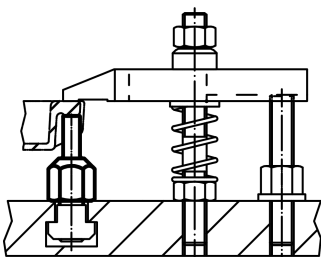

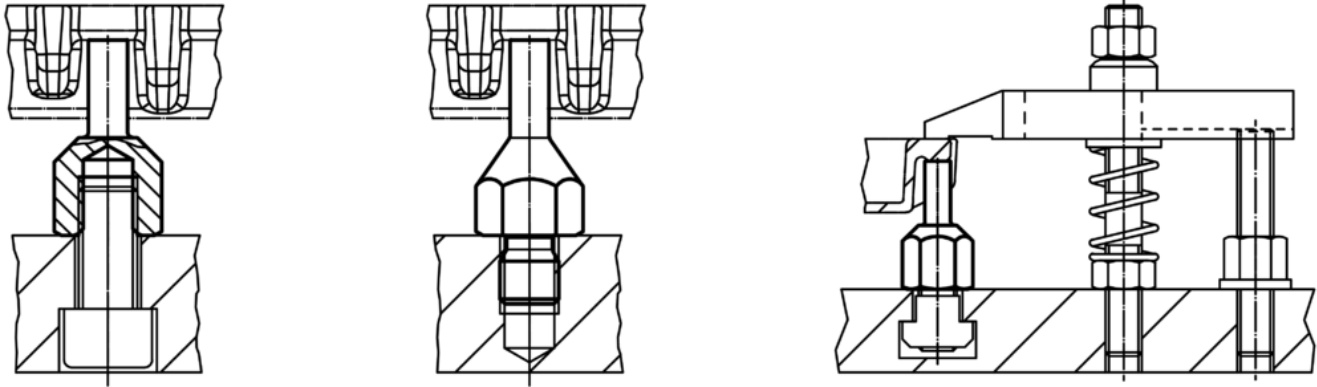

## Compliance

### RoHS compliant

Compliant according to Directive 2011/65/EU and Directive 2015/863

### Does not contain SVHC substances

No SVHC substances with more than 0.1% w/w contained - SVHC list [REACH] as of 10.06.2022

### Does not contain Proposition 65 substances

No Proposition 65 substances included  
<https://www.P65Warnings.ca.gov/>

### Free from Conflict Minerals

This product does not contain any substances designated as "conflict minerals" such as tantalum, tin, gold or tungsten from the Democratic Republic of Congo or adjacent countries.