

LQM18DZ220M70L

“#” indicates a package specification code.

Bias Current Characteristics Improved



< List of part numbers with package codes >

LQM18DZ220M70B LQM18DZ220M70L

Appearance & Shape

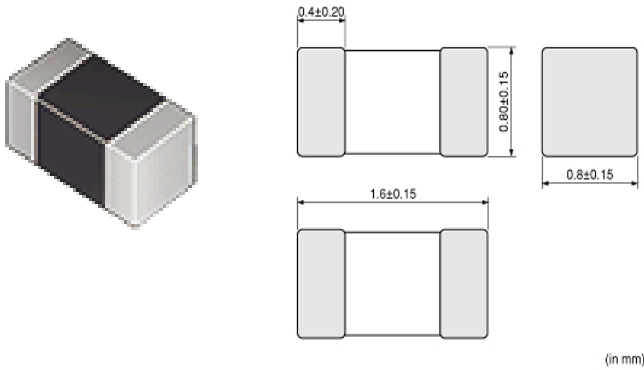

References

| Packaging | Specifications | Standard Packing Quantity |
|-----------|------------------|---------------------------|
| B | Bulk(Bag) | 1000 |
| L | 180Embossed Tape | 4000 |

| Mass (typ.) | |
|-------------|--------|
| 1 piece | 0.005g |

Attention

- 1.This datasheet is downloaded from the website of Murata Manufacturing Co., Ltd. Therefore, it's specifications are subject to change or our products in it may be discontinued without advance notice. Please check with our sales representatives or product engineers before ordering.
- 2.This datasheet has only typical specifications because there is no space for detailed specifications. Therefore, please review our product specifications or consult the approval sheet for product specifications before ordering.

LQM18DZ220M70L

“#” indicates a package specification code.



Specifications

| | |
|---|----------------|
| L size | 1.6±0.15mm |
| W size | 0.8±0.15mm |
| T size | 0.8±0.15mm |
| Size code inch (mm) | 0603 (1608) |
| Inductance | 22μH±20% |
| Inductance Test Frequency | 1MHz |
| Rated current (Isat) (Based on Inductance change) | 50mA |
| Rated current (Itemp) (Based on Temperature rise) | 200mA |
| Max. of DC resistance | 3.12Ω |
| Class of magnetic shield | Ferrite Core |
| Self resonance frequency (min.) | 15MHz |
| DC Resistance Intermediate Values | 2.4Ω±0.72Ω |
| Operating Temperature Range | -55°C to 125°C |
| Series | LQM18DZ_70 |

Attention

1.This datasheet is downloaded from the website of Murata Manufacturing Co., Ltd. Therefore, it's specifications are subject to change or our products in it may be discontinued without advance notice. Please check with our sales representatives or product engineers before ordering.

2.This datasheet has only typical specifications because there is no space for detailed specifications.

Therefore, please review our product specifications or consult the approval sheet for product specifications before ordering.