



Figure can vary

**Part no.: 50128200**

**PRK5.M3/4P-M8**

**Polarized retro-reflective photoelectric sensor**



## Contents

- Technical data
- Dimensioned drawings
- Electrical connection
- Diagrams
- Operation and display
- Reflectors & reflective tapes
- Part number code
- Notes
- Accessories

## Technical data

<b>Basic data</b>	
Series	5
Operating principle	Reflection principle
Application	Detection of bottle container Detection of semi-transparent media
<b>Optical data</b>	
Operating range	Guaranteed operating range
Operating range	0.02 ... 4.5 m , With reflector TK(S) 100x100
Operating range limit	Typical operating range
Operating range limit	0.02 ... 6 m , With reflector TK(S) 100x100
Light source	LED , Red
LED light wavelength	620 nm
LED group	Exempt group (in acc. with EN 62471)
Transmitted-signal shape	Pulsed
<b>Electrical data</b>	
Protective circuit	Polarity reversal protection Short circuit protected
<b>Performance data</b>	
Supply voltage $U_B$	10 ... 30 V , DC , Incl. residual ripple
Residual ripple	0 ... 15 % , From $U_B$
Open-circuit current	0 ... 20 mA
<b>Outputs</b>	
Number of digital switching outputs	2 Piece(s)
<b>Switching outputs</b>	
Voltage type	DC
Switching current, max.	100 mA
Switching voltage	high: $\geq(U_B-2.5V)$ low: $\leq 2.5V$
<b>Switching output 1</b>	
Assignment	Connection 1, pin 4
Switching element	Transistor , PNP
Switching principle	Light switching
<b>Switching output 2</b>	
Assignment	Connection 1, pin 2
Switching element	Transistor , PNP
Switching principle	Dark switching
<b>Timing</b>	
Switching frequency	500 Hz
Response time	1 ms
Readiness delay	300 ms
<b>Connection</b>	

Part no.: 50128200 – PRK5.M3/4P-M8 – Polarized retro-reflective photoelectric

#### Connection 1

Function	Signal OUT Voltage supply
Type of connection	Connector
Thread size	M8
Type	Male
Material	Plastic
No. of pins	4 -pin

#### Mechanical data

Dimension (W x H x L)	14 mm x 32.5 mm x 20.2 mm
Housing material	Plastic , ABS
Lens cover material	Plastic
Net weight	20 g
Housing color	Black Red

#### Operation and display

Type of display	LED
Number of LEDs	2 Piece(s)
Operational controls	Teach button

#### Environmental data

Ambient temperature, operation	-40 ... 60 °C
Ambient temperature, storage	-40 ... 70 °C

#### Certifications

Degree of protection	IP 67
Protection class	III
Certifications	c UL US
Standards applied	IEC 60947-5-2

#### Classification

Customs tariff number	85365019
eCl@ss 8.0	27270902
eCl@ss 9.0	27270902
ETIM 5.0	EC002717
ETIM 6.0	EC002717

## Dimensioned drawings

All dimensions in millimeters

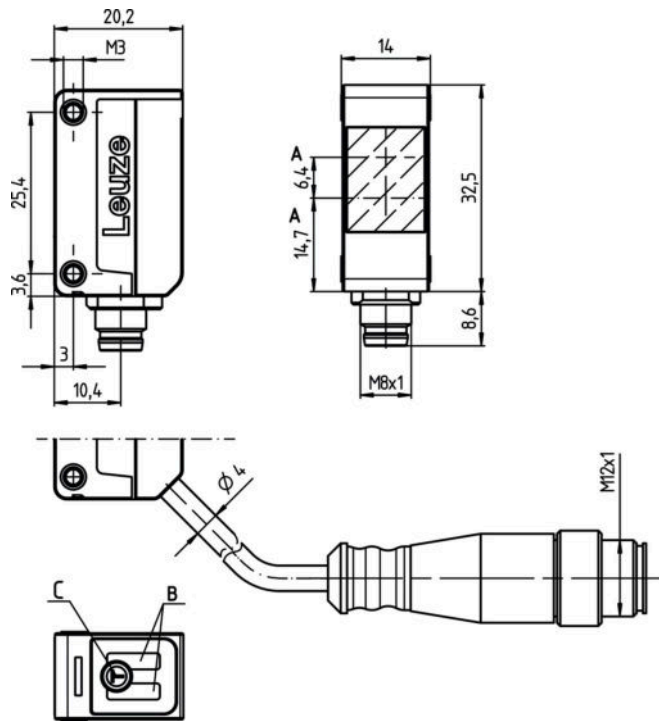

A Optical axis  
 B Indicator diode  
 C Teach button

## Electrical connection

Connection 1	
Function	Signal OUT Voltage supply
Type of connection	Connector
Thread size	M8
Type	Male
Material	Plastic
No. of pins	4 -pin
Encoding	

Pin	Pin assignment
1	V+
2	OUT 2
3	GND
4	OUT 1

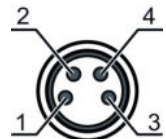

**Diagrams**

Typ. response behavior (TKS100x100)

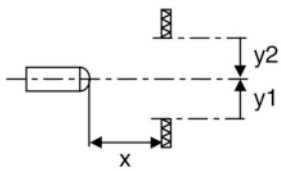
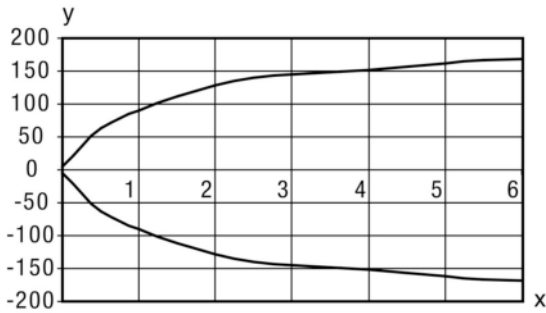

x Distance [m]  
y Misalignment [mm]

Typ. function reserve

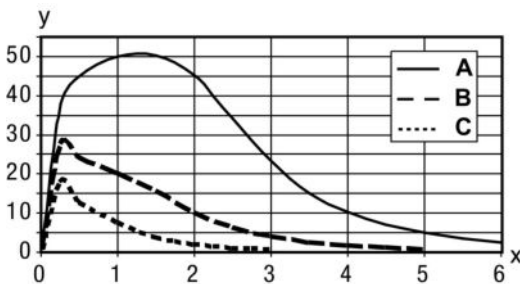

x Distance [m]  
y Function reserve  
A TKS 100x100  
B TKS 40x60  
C TKS 20x40

**Operation and display**

LEDs

LED	Display	Meaning
1	Yellow, continuous light	Light path free
	Yellow, flashing	Light path free, no function reserve
2	Green, continuous light	Operational readiness

**Reflectors & reflective tapes**

	Part no.	Designation	Operating range/ Operating range limit	Description
	50108300	REF 4-A-50x50	0.08 ... 1.4 m 0.08 ... 2 m	Design: Rectangular Reflective surface: 50 mm x 50 mm Material: Plastic Chemical designation of the material: PMMA Fastening: Self-adhesive
	50003192	TK 100x100	0.02 ... 4.5 m 0.02 ... 6 m	Design: Rectangular Reflective surface: 96 mm x 96 mm Triple reflector size: 4 mm Material: Plastic Base material: Plastic Chemical designation of the material: PMMA8N Fastening: Adhesive
	50003189	TK 30x50	0.03 ... 1.9 m 0.03 ... 2.5 m	Design: Rectangular Reflective surface: 29 mm x 45 mm Triple reflector size: 4 mm Material: Plastic Base material: Plastic Chemical designation of the material: PMMA8N Fastening: Adhesive
	50024127	TK 82.2	0.05 ... 3.6 m 0.05 ... 4.5 m	Design: Round Triple reflector size: 4 mm Reflection surface diameter: 79 mm Material: Plastic Base material: Plastic Chemical designation of the material: PMMA8N Fastening: Through-hole mounting, Adhesive
	50022816	TKS 100X100	0.02 ... 4.5 m 0.02 ... 6 m	Design: Rectangular Reflective surface: 96 mm x 96 mm Triple reflector size: 4 mm Material: Plastic Base material: Plastic Chemical designation of the material: PMMA8N Fastening: Through-hole mounting, Adhesive
	50081283	TKS 20X40	0.04 ... 1.6 m 0.04 ... 2.2 m	Design: Rectangular Reflective surface: 16 mm x 38 mm Triple reflector size: 2.3 mm Material: Plastic Base material: Plastic Chemical designation of the material: PMMA8N Fastening: Through-hole mounting, Adhesive
	50023525	TKS 30X50	0.03 ... 1.9 m 0.03 ... 2.5 m	Design: Rectangular Reflective surface: 27 mm x 44 mm Triple reflector size: 3 mm Material: Plastic Base material: Plastic Chemical designation of the material: PMMA8N Fastening: Through-hole mounting, Adhesive
	50040820	TKS 40X60	0.02 ... 3 m 0.02 ... 4 m	Design: Rectangular Reflective surface: 37 mm x 56 mm Triple reflector size: 4 mm Material: Plastic Base material: Plastic Chemical designation of the material: PMMA8N Fastening: Through-hole mounting, Adhesive

## Part number code

Part designation: AAA5d.EE/ ff-GG-hh-l

AAA5	<b>Operating principle / construction:</b> HT5: diffuse reflection sensor with background suppression LS5: throughbeam photoelectric sensor transmitter LE5: throughbeam photoelectric sensor receiver ET5: energetic diffuse reflection sensor FT5: diffuse reflection sensor with fading PRK5: retro-reflective photoelectric sensor with polarization filter
d	<b>Light type:</b> n/a: red light l: infrared light
EE	<b>Equipment:</b> 1: adjustable range M: for semi-transparent objects H: for the detection of transparent films X: reinforced fading 3: teach-in via button R: combination product for reflector DTKS 30x50
ff	<b>Switching output / function / OUT1OUT2 (OUT1 = pin 4, OUT2 = pin 2):</b> 2: NPN transistor output, light switching N: NPN transistor output, dark switching 4: PNP transistor output, light switching P: PNP transistor output, dark switching X: pin not used 9: deactivation input (deactivation with high signal) D: deactivation input (deactivation with low signal)
GG	<b>Design:</b> P1: narrow light beam
hh	<b>Electrical connection:</b> n/a: cable, standard length 2000 mm, 4-wire M8: M8 connector, 4-pin (plug) M8.3: M8 connector, 3-pin (plug) 200-M8: cable, length 200 mm with M8 connector, 4-pin, axial (plug) 200-M8.3: cable, length 200 mm with M8 connector, 3-pin, axial (plug) 200-M12: cable, length 200 mm with M12 connector, 4-pin, axial (plug) M8.1: Snap-in, M8 connector, 4-pin (plug)
l	<b>Configuration:</b> P1: different configuration

### Note

A list with all available device types can be found on the Leuze electronic website at [www.leuze.com](http://www.leuze.com).

## Notes

### Observe intended use!

- This product is not a safety sensor and is not intended as personnel protection.
- The product may only be put into operation by competent persons.
- Only use the product in accordance with its intended use.

### For UL applications:





- Only for use in "class 2" circuits
- These proximity switches shall be used with UL Listed Cable assemblies rated 30V, 0.5A min, in the field installation, or equivalent (categories: CYJV/CYJV7 or PVVA/PVVA7)

- Sum of the output currents for both outputs, 50 mA for ambient temperatures > 40 °C



Part no.: 50128200 – PRK5.M3/4P-M8 – Polarized retro-reflective photoelectric

## Accessories



### Connection technology - Connection cables

	Part no.	Designation	Article	Description
 	50130850	KD U-M8-4A-V1-050	Connection cable	Connection 1: Connector, M8, Axial, Female, 4 -pin Connection 2: Open end Shielded: No Cable length: 5,000 mm Sheathing material: PVC
 	50130871	KD U-M8-4W-V1-050	Connection cable	Connection 1: Connector, M8, Angled, Female, 4 -pin Connection 2: Open end Shielded: No Cable length: 5,000 mm Sheathing material: PVC

### Mounting technology - Mounting brackets

	Part no.	Designation	Article	Description
	50118542	BT 200M.5	Mounting bracket	Design of mounting device: Angle, L-shape Fastening, at system: Through-hole mounting Mounting bracket, at device: Screw type, Suited for M3 screws Type of mounting device: Adjustable Material: Stainless steel
	50124651	BT 205M-10SET	Mounting device set	Contains: 10x Design of mounting device: Angle, L-shape Fastening, at system: Through-hole mounting Mounting bracket, at device: Screw type Type of mounting device: Rigid Material: Metal

### Mounting technology - Rod mounts

	Part no.	Designation	Article	Description
	50117829	BTP 200M-D12	Mounting system	Design of mounting device: Protection hood Fastening, at system: For 12 mm rod Mounting bracket, at device: Screw type Type of mounting device: Clampable, Adjustable, Turning, 360° Material: Metal
	50117255	BTU 200M-D12	Mounting system	Contains: 2x M3 x 16 screw, 2 M3 x 20 screws, 2x position washers Design of mounting device: Mounting system Fastening, at system: For 12 mm rod, Sheet-metal mounting Mounting bracket, at device: Screw type, Suited for M3 screws Type of mounting device: Clampable, Adjustable, Turning, 360° Material: Metal



Part no.: 50128200 – PRK5.M3/4P-M8 – Polarized retro-reflective photoelectric

## Standard reflectors

	Part no.	Designation	Article	Description
	50109257	TKS 40x60.1	Reflector	Design: Rectangular Reflective surface: 37 mm x 56 mm Triple reflector size: 2.3 mm Material: Plastic Base material: Plastic Chemical designation of the material: PMMA8N Fastening: Through-hole mounting, Adhesive

## Micro-triad-type reflectors

	Part no.	Designation	Article	Description
	50117583	MTKS 50x50.1	Reflector	Design: Rectangular Reflective surface: 50 mm x 50 mm Triple reflector size: 1.2 mm Material: Plastic Base material: Plastic Chemical designation of the material: PMMA8N Fastening: Through-hole mounting, Adhesive

### Note

A list with all available accessories can be found on the Leuze electronic website in the Download tab of the article detailed page.