

**M12 MALE 90° / M8 FEMALE 90°**

PUR 3x0.25 GRAY, 0.6m

Male 90° to female 90°

M12 - M8, 3-pole

Plastic housings with good resistance against chemicals and oils. The resistance to aggressive media should be individually tested for your application. Further details on request. Further cable lengths on request.

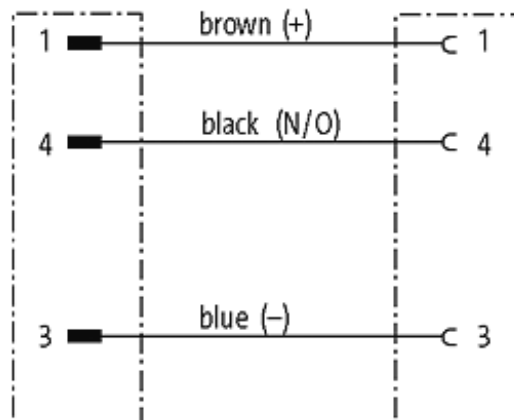
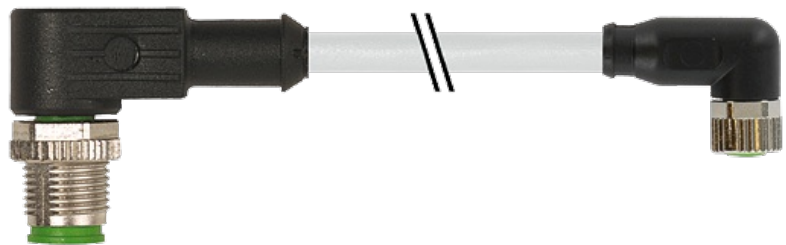
**[Link to Product](#)****Illustration**

Male

Female

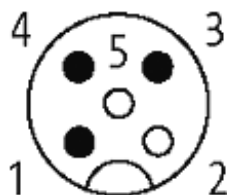

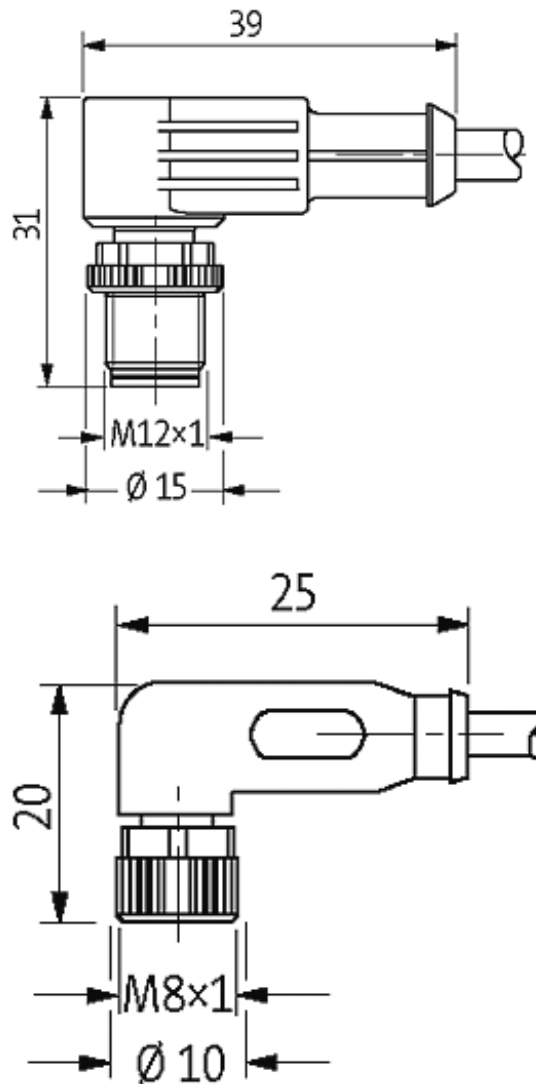

Product may differ from Image

### Approvals



### Form

40681

### Technical Data

Protection	IP67 inserted and tightened (EN 60529)
Locking of ports	Screw thread M8/M12 × 1 mm (recommended torque 0.4/0.6 Nm), self-securing
Operating voltage	max. 250 V AC/DC
Operating current per contact	max. 4 A

### Cables

Cable number	220
--------------	-----

No./diameter of wires	3 × 0.25 mm <sup>2</sup>
Wire isolation	PVC (br, bl, bk)
C-track properties	2 Mio.
Jacket Color	gray
Shore hardness outer jacket	85 ± 5A
Material (jacket)	PUR/PVC (UL/CSA)
Outer diameter	approx. 4.5 mm
Bend radius (fixed)	10 × outer Ø
Bend radius (moving)	15 × outer Ø
Temperature range (fixed)	-30...+80 °C
Temperature range (mobile)	-5...+80 °C

#### General data

Temperature range	-25...+85 °C, depending on cable quality
-------------------	--

#### Commercial data

country of origin	DE
customs tariff number	85444290
minimum order quantity	1