

groov 5–60 VDC Output Modules

Features

- > 12 channels per module
- > Module cover with LED indicates module status
- > Channel-specific LEDs simplify troubleshooting
- > Touch-sensitive pad triggers display of module information on *groov* EPIC® processor
- > Operating temperature: -20 to 70 °C
- > UL Hazardous Locations approved and ATEX compliant
- > Guaranteed for life

DESCRIPTION

groov I/O modules are part of the *groov* EPIC® (Edge Programmable Industrial Controller) system. Wired directly to field devices (sensors and actuators), *groov* I/O translates the electrical signals from those devices into the digital language computers understand—so you can monitor and control devices and use their data wherever you need it, in your local computer network or in cloud services.

These *groov* DC output modules provide 12 isolated channels of 5–60 VDC output, each switching a separate DC load. The module features channel-specific LEDs for troubleshooting.

Choose the module you need based on your requirements:

- The **GRV-ODCI-12** includes a full set of features.
- The **GRV-ODCIS-12** switches output on or off only, offering a lower cost option for projects with simple requirements.

See “Features and Specifications” on page 2 for additional differences.

Wiring is simplified with a top-mounted connector, which provides spring-clamp terminals for power, common, and field wiring. The connector is held in place by a single, captive retention screw but can be removed with the field wiring intact for wiring in advance or easier module field replacement.

A swinging, two-position cover protects wiring from inadvertent contact, as does the dead-front design. The two positions of the cover offer the option of more space to accommodate larger wire. The module cover provides a touch-sensitive pad; touch the pad and the *groov* EPIC processor displays information about the module, including specifications and a wiring diagram.



GRV-ODCI-12 Output Module

The module pivots into place and is held securely in place by a captive retention screw.

groov I/O modules are hot swappable (which means they can be installed or removed without turning off the unit or stopping the process) and self-identifying—as soon as you mount the module to the chassis, it communicates to the processor and identifies itself.

Each *groov* I/O module cover provides a large module LED to indicate module health at a glance. Discrete modules also include channel-specific LEDs that display the on/off status of each channel.

All *groov* power supplies, voltage converters, adapters, and processors, are UL/cUL listed and compliant with the ATEX, Low Voltage, and EMC CE directives. Each module is factory tested twice before shipment and almost every module is guaranteed for life.



Part Numbers

Part	Description
GRV-ODCI-12	DC digital output, 12 channels, 5–60 VDC, channel-to-channel isolation
GRV-ODCIS-12	DC digital output, 12 channels, 5–60 VDC, channel-to-channel isolation, on/off only

FEATURES AND SPECIFICATIONS

Features

Feature	GRV-ODCI-12	GRV-ODCIS-12
Number of channels	12	12
Channel-to-channel isolation	x	x
On/off state	x	x
On/off totalization	x	
Output pulsing	x	

Specifications

Specification	GRV-ODCI-12	GRV-ODCIS-12
Line Voltage Range (nominal)	5–48 VDC	5–48 VDC
Line Voltage Range (max)	5–60 VDC	5–60 VDC
Current Rating	400 mA per channel or 4.8 A per module (70 °C)	400 mA per channel or 4.8 A per module (70 °C)
Surge Current	5 A peak for 1 second	5 A peak for 1 second
Recommended Max. Fuse (fast) or Circuit Breaker	3 A 60 VDC / channel, 6 A 60 VDC / module	3 A 60 VDC / channel, 6 A 60 VDC / module
Minimum Load	20 mA	20 mA
Output Voltage Drop	1.2 V max.	1.2 V max.
Off-State Leakage	1 mA at 60 V	1 mA at 60 V
Peak Blocking Voltage	60 V	60 V
Problem Indication	N/A	N/A
Isolation (field-to-logic)	300 V working, 1500 V transient (1 minute)	300 V working, 1500 V transient (1 minute)
Isolation (channel-to-channel)	300 V working, 1500 V transient (1 minute)	300 V working, 1500 V transient (1 minute)
Number of Channels	12	12
Chassis Power Consumption	1.2 W	1.2 W
Wire Size	28–14 AWG	28–14 AWG
Torque, connector screw	2.5 in-lb (0.28 N-m)	2.5 in-lb (0.28 N-m)
Torque, hold-down screw	3.5 in-lb (0.4 N-m)	3.5 in-lb (0.4 N-m)
Temperature (operating)	-20 °C to +70 °C	-20 °C to +70 °C
Temperature (storage)	-40 °C to +85 °C	-40 °C to +85 °C
Relative Humidity (non-condensing)	5–95%	5–95%
Agency Approvals	UL/cUL (Class 1 Div. 2); CE, ATEX (Category 3, Zone 2), RoHS; DFARS; CB Scheme	UL/cUL (Class 1 Div. 2); CE, ATEX (Category 3, Zone 2), RoHS; DFARS; CB Scheme
Warranty	Lifetime	Lifetime

MOUNTING

Mount *groov* I/O modules onto a *groov* EPIC chassis. See [groov EPIC Chassis Data Sheet](#) (form 2247). You may also want to review the diagrams in the Description of Module Parts section so you learn the names of the various parts of the module.

Installing a Module

The numbers on the diagrams correspond to the numbered steps in these instructions.

CAUTION: For electrical safety, turn off power to the chassis and de-energize field devices wired to the terminal connector before starting.

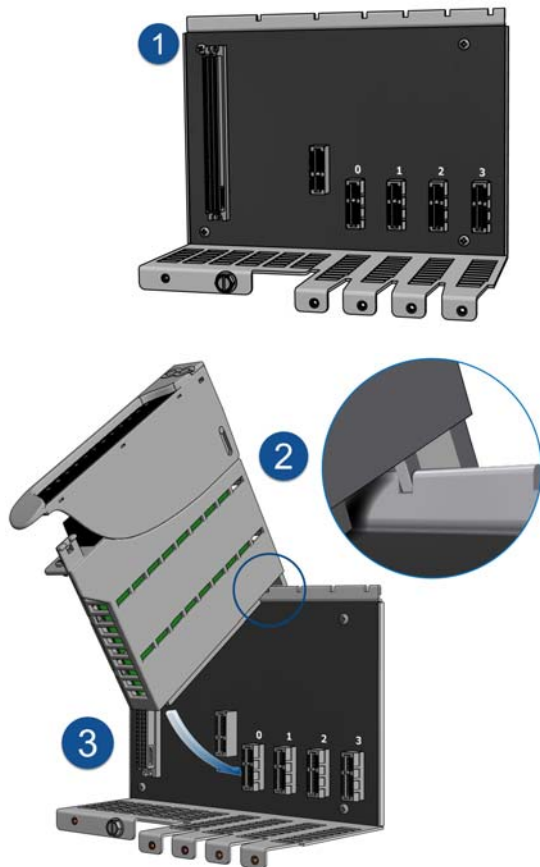

1. Orient the *groov* EPIC chassis so that the module connector numbers are right-side up, with module connector zero on the left, as shown in the diagram.
2. Hold the module at a 45° angle, lining up the alignment tab on the back tip of the module with the slot at the back of the chassis.
3. Pivot the front of the module down to the module connector on the chassis. Push to snap the module into the connector.
4. Swing the module cover up so you can access the module retention screw. Secure the module into position by tightening the module retention screw.

CAUTION: Do not over-tighten. See the torque specs in the Specifications table.

5. If the module does not have a terminal connector, install one.
6. Secure the terminal connector by tightening the terminal connector screw.

CAUTION: Do not over-tighten. See the torque specs in the Specifications table.

7. Follow the wiring instructions in the Pinout and Wiring section to wire your field devices to the channels on the terminal connector.
8. When wiring is complete, swing the module cover back down to cover the wires. If the wires are too thick to close the module cover easily, lift the module cover, then raise the back of the module cover up to the higher position. Swing the module cover back down to cover the wires.

When you are done installing modules and wiring, if you powered down your unit, you can turn it back on.

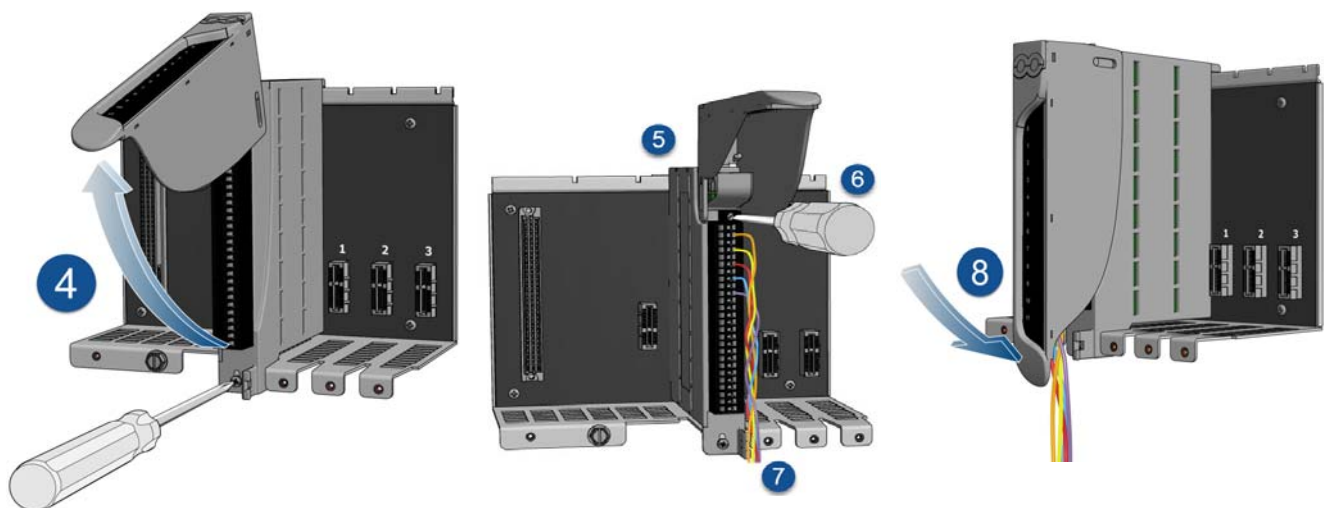

Removing a Module

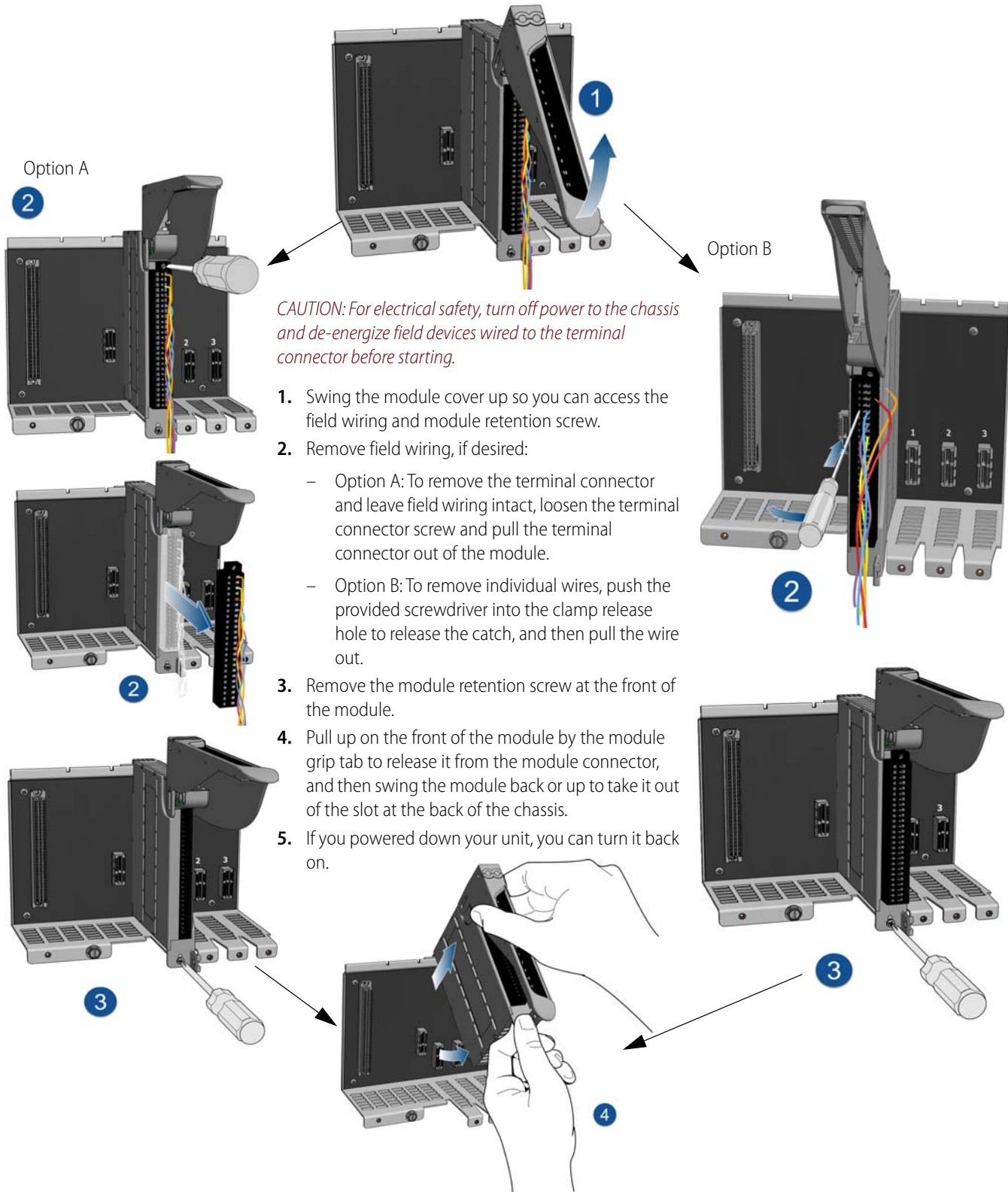

PINOUTS AND WIRING

Before you begin wiring, do the following tasks:

CAUTION: For electrical safety, turn off power to the chassis and de-energize field devices wired to the terminal connector before starting.

- Select the appropriate wire. The terminal connectors are rated for 28–14 AWG wire. If you're using stranded wire, tin the strands for an easier, better connection.
- Ensure that you have the screwdriver supplied with your module.
- If you are unfamiliar with the names of some of the parts of the module, review the diagrams on this page and in the Description of Module Parts section.
- It may be easier to insert wires if you remove the terminal connector from the module. To remove the terminal connector, loosen the terminal connector screw at one end of the connector, then pull the connector straight out to remove it from the module.
- If you have never used a spring-clamp wiring system, take a moment to familiarize yourself with the diagram below. The clamp release hole is where you will insert the screwdriver. The field wiring hole is where you will insert your field wires.

If you look into the field wiring hole, you will see a highly reflective surface. If you can see that surface, that means that the clamp is closed.

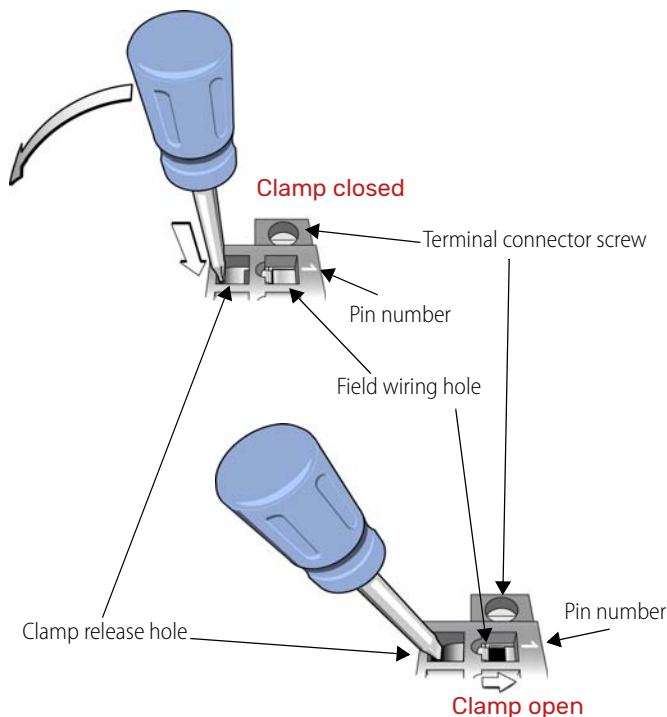

GRV-ODCI-12 and GRV-ODCIS-12 modules should be installed with appropriate external over-current protection devices (DC rated fuse or circuit breaker). See "Specifications" on page 2 for recommended values. Failure to provide adequate over-current protection may result in damage not covered by the Opto 22 warranty.

Follow these instructions to connect your field wires to the module:

CAUTION: For electrical safety, turn off power to the chassis and de-energize field devices wired to the terminal connector before starting.











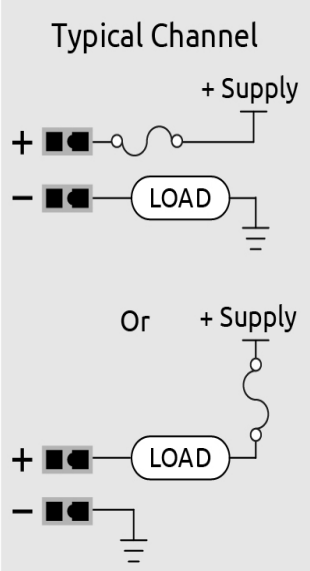















1. Orient the module or terminal connector to match the wiring diagrams on the following page. To make it easier to handle the screwdriver and the field wires, secure the module by doing one of the following:
 - If you are working with the terminal connector while it is attached to the module, make sure the module is screwed securely to the chassis.
 - If you are working only with the terminal connector, secure the terminal connector with a clamp.
2. Hold the screwdriver so that you can place the flat side of the blade against the left side of the clamp release hole.
3. Slide the screwdriver into the clamp release hole, along the left side, until you feel the blade begin to meet some resistance. Gently push the screwdriver in a little more, until you feel the screwdriver stop.

Note: If you push in too hard, the screwdriver might pop out of the clamp release hole and you'll have to return to step 2.

 - Look into the field wiring hole. If it is dark, the clamp is open. You can go to the next step.
 - If you can still see the highly reflective surface, gently pull the screwdriver handle to the left until you feel the blade stop. Hold the screwdriver in that position. Look into the field wiring hole. If it is dark, the clamp is open. You can go to the next step.
4. Insert the wire into the field wiring hole until it meets complete resistance. Then pull out the screwdriver.
5. Test that the wire is secure by gently pulling on it. If the wire pulls out, repeat steps 2 through 4.

To remove a wire, push the screwdriver into the clamp release hole as described in steps 2 and 3 above, and then pull the wire out.

WIRING: GRV-ODCI-12, GRV-ODCIS-12

Internal	Pin	External Wiring
Channels internally isolated		
Channel 0	1  +	<div style="border: 1px solid gray; padding: 5px;"> <p>Typical Channel</p>  <p>Or</p> </div>
	2  -	
Channel 1	3  +	
	4  -	
Channel 2	5  +	
	6  -	
Channel 3	7  +	
	8  -	
Channel 4	9  +	
	10  -	
Channel 5	11  +	
	12  -	
	13  Unused	
	14  Unused	
Channel 6	15  +	
	16  -	
Channel 7	17  +	
	18  -	
Channel 8	19  +	
	20  -	
Channel 9	21  +	
	22  -	
Channel 10	23  +	
	24  -	
Channel 11	25  +	
	26  -	

All loads
require user
supplied fuses

DIMENSIONS: GRV-ODCI-12, GRV-ODCIS-12

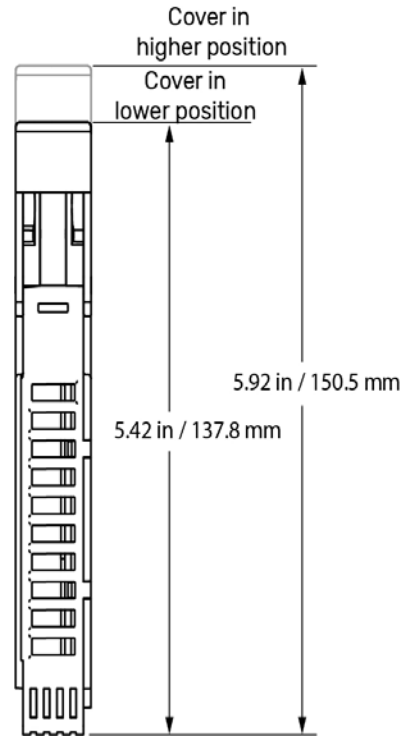
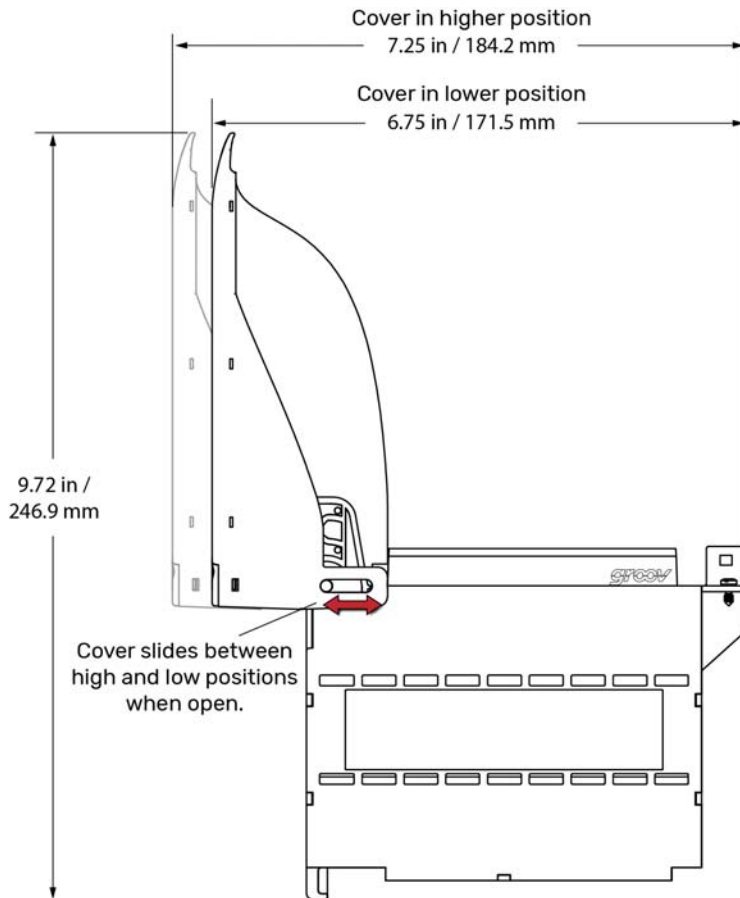

The module cover pivots and can be adjusted to two different heights (positions). The higher position provides more space to accommodate thicker wires.

To switch between higher and lower position, open the cover to at least a 45° angle. Grasp the hinged end of the module cover and do one of the following:

- Pull up on the back hinge to slide it to the higher position.
- Push down on the back hinge to slide it to the lower position.

You cannot switch between the higher and lower positions while the cover is closed.

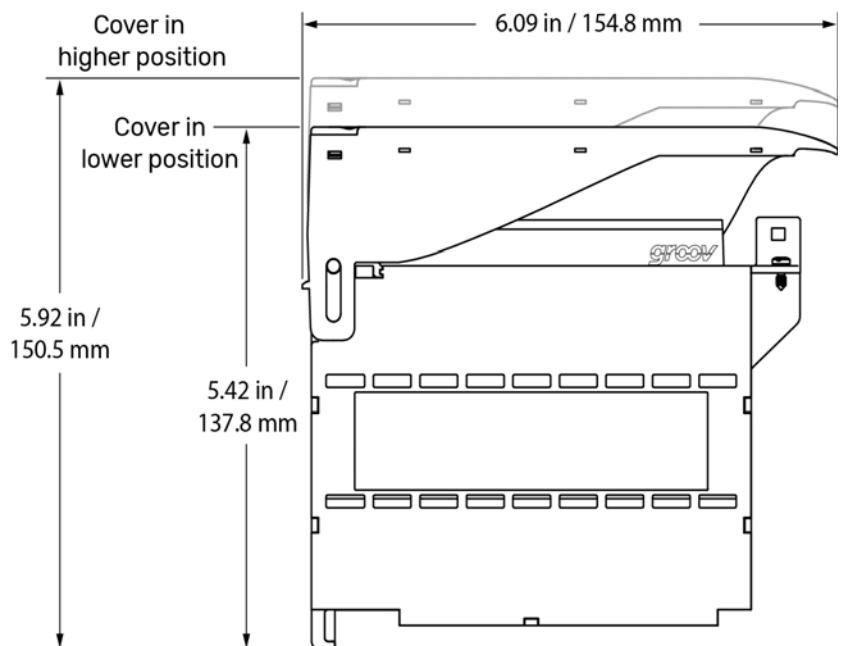

DIMENSIONS: GRV-ODCI-12, GRV-ODCIS-12



DESCRIPTION OF MODULE PARTS

The following diagram identifies the parts of the modules. The installation instructions in the documentation rely on these terms to describe how to handle the module.

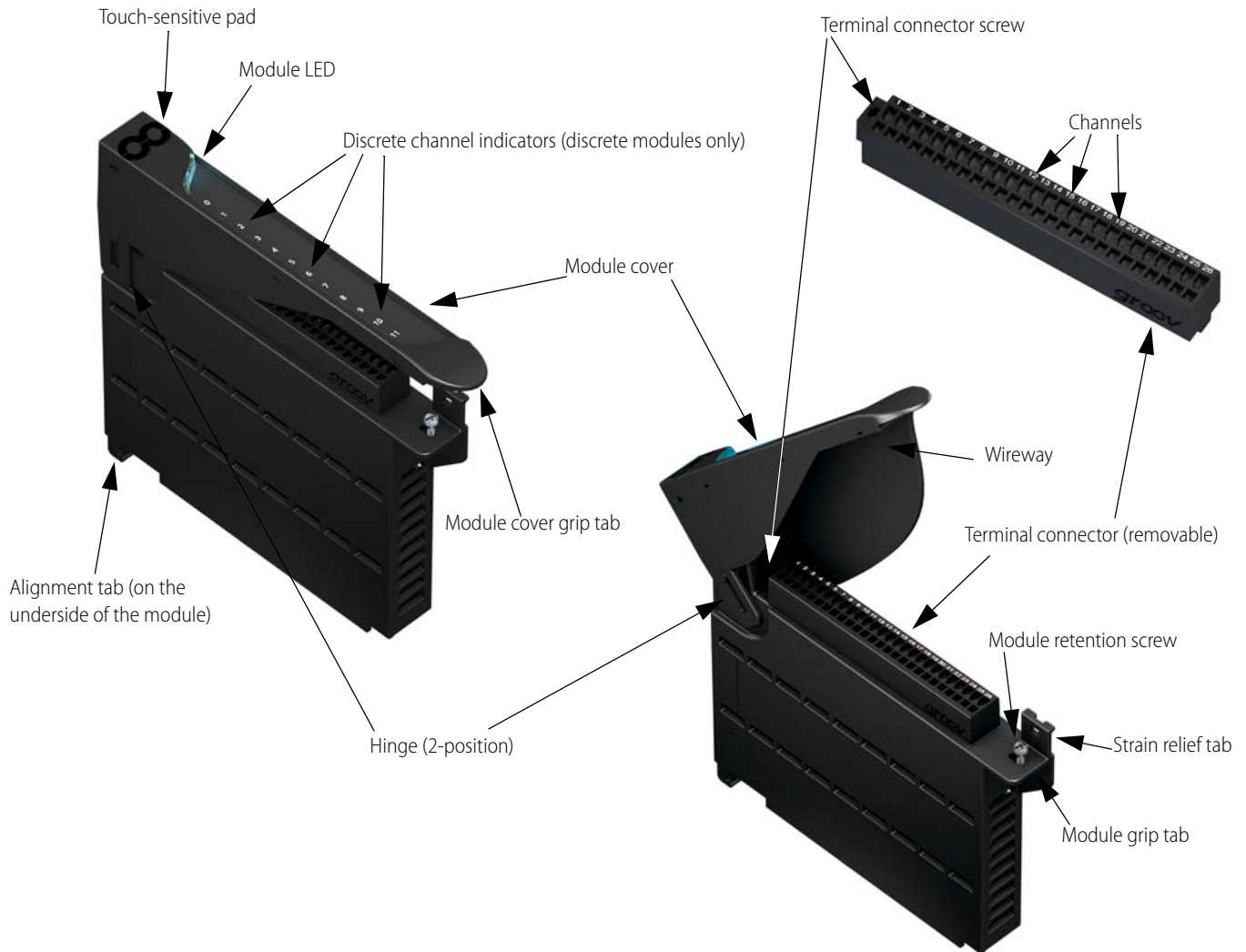

Some parts offer unique features:

- Module LED:** Provides a visual indication of the health of the module. For example, if it is blue, the module is operating normally. If it is blinking blue, the module's information is being displayed on the *groov* EPIC processor's screen. For a complete list of the various colors that this LED might display, see the [groov EPIC User's Guide](#) (form 2267).
- Terminal connector:** Specially designed for *groov* I/O modules, it provides a spring-clamp wiring system to securely connect the wires from your field devices to the module. To learn how to use a spring-clamp wiring system, see the Pinouts and Wiring section.
- Hinge and Wireway:** These two features work together to provide more space for wires. The hinge can be adjusted between a lower position and a higher position. The wireway is the space underneath the module cover. To increase this space, you can raise the hinge to the higher position.
- Discrete channel indicators:** Available only on discrete modules, the indicators are lit when the channel is on.
- Touch-sensitive pad:** Offers a convenient way to display the module's information on the *groov* EPIC processor. Press on the pad for approximately two seconds and the processor displays that module's information on the screen, as well as changing the module LED to a blinking blue light.

PRODUCTS

Opto 22 develops and manufactures reliable, easy-to-use, open standards-based hardware and software products.

Industrial automation, process control, building automation, industrial refrigeration, remote monitoring, data acquisition, and industrial internet of things (IIoT) applications worldwide all rely on Opto 22.

groov EPIC® System

Opto 22's *groov* Edge Programmable Industrial Controller (EPIC) system is the culmination of over 40 years of experience in designing products for the automation industry.

groov EPIC gives you an industrially hardened system with guaranteed-for-life I/O, a flexible Linux®-based controller with gateway functions, and software for your IIoT application or any application.

groov EPIC I/O

I/O provides the local connection to sensors and equipment. *groov* I/O offers up to 24 channels on each I/O module, with a spring-clamp terminal strip, integrated wireway, and swing-away cover.

Opto 22 I/O is so reliable, we can afford to guarantee it for life. *groov* I/O is hot swappable, UL Hazardous Locations approved, and ATEX compliant.

groov EPIC Controller

The heart of the system is the *groov* EPIC controller. It handles a wide range of digital, analog, and serial functions for data collection, remote monitoring, process control, and discrete and hybrid manufacturing.

In addition, the EPIC provides secure data communications among physical assets, control systems, software applications, online services, and more, both on premises and in the cloud.

Configuring and troubleshooting I/O and networking is easier with the EPIC's integrated high-resolution touchscreen. Authorized users can see your *groov* View HMI locally on the touchscreen or on a monitor connected via the HDMI or USB ports.

groov EPIC Software

Software includes:

- Flowchart-based PAC Control for control programming, or build your own custom application with optional secure shell access
- *groov* View for building and viewing your own device-independent HMI
- Node-RED for creating simple logic flows from pre-built nodes

- Ignition Edge® from Inductive Automation®, with OPC-UA drivers to Allen-Bradley®, Siemens®, and other control systems, and MQTT/Sparkplug communications for efficient IIoT data transfer

groov Edge Appliance

Visualization, data handling, and connectivity in a compact, industrial box: that's the *groov* Edge Appliance. Included are:

- *groov* View for building and viewing operator interfaces on PCs and mobile
- Node-RED for building simple logic flows
- Ignition Edge® from Inductive Automation®, for OPC-UA drivers and MQTT/Sparkplug IIoT communications



Older products

From solid state relays (our first products) to world-famous G4 and SNAP I/O, to SNAP PAC controllers, Opto 22 products last a long time. You can count on us to give you the reliability and service you expect.



QUALITY

Founded in 1974, Opto 22 has established a worldwide reputation for high-quality products. All are made in the U.S.A. at our manufacturing facility in Temecula, California.

Because we test each product twice before it leaves our factory rather than testing a sample of each batch, we can guarantee most solid-state relays and optically isolated I/O modules for life.

FREE PRODUCT SUPPORT

Opto 22's California-based Product Support Group offers free, comprehensive technical support for Opto 22 products from engineers with decades of training and experience. Support is available in English and Spanish by phone or email, Monday–Friday, 7 a.m. to 5 p.m. PST.

Support is always available on our website, including how-to videos, user's guides, the Opto 22 KnowledgeBase, troubleshooting tips, and OptoForums. In addition, free hands-on training is available at our Temecula, California headquarters, and you can [register online](#).

PURCHASING OPTO 22 PRODUCTS

Opto 22 products are sold directly and through a worldwide network of distributors, partners, and system integrators. For more information, contact Opto 22 headquarters at **800-321-6786** (toll-free in the U.S. and Canada) or **+1-951-695-3000**, or visit our website at www.opto22.com.