









**CBRS Chip Antenna**  
**Off Ground SMT Monopole**  
**W3154: 3500 – 3980 MHz**



*Features:*

-  Compact size 3.20 x 1.56 x 1.10 mm (WxLxH)
-  Low weight 33 mg
-  Fully SMD compatible
-  MSL: 1
-  Tape and reel packing

*Applications;*

-  CBRS B48
-  C-band B43
-  Portable radios
-  IoT, safety and security -devices

**ELECTRICAL SPECIFICATIONS +25° C**

**W3154**

Antenna type	Nominal Impedance	Polarization	Radiation pattern	Power withstanding
Monopole	50Ω	Linear	Omni	3W
<b>Frequency (MHz)</b>		3500 - 3980		
<b>Return Loss(dB)</b>		< 6		
<b>Peak Gain (dBi)</b>		2.5		
<b>Efficiency (%)</b>		65		

**MECHANICAL SPECIFICATIONS**

**Orderable P/N: W3154**

Dimension (Length x Width x Height)	Material	Color
3.2mm x 1.56mm x 1.1mm (.126" x .061" x .043")	ceramic	grey

**ENVIRONMENTAL SPECIFICATIONS**

**W3154**

Storage Temperature	Operating Temperature	MSL-Level	RoHS Compliant
-40/+85° C	-40/+85° C	1	Yes

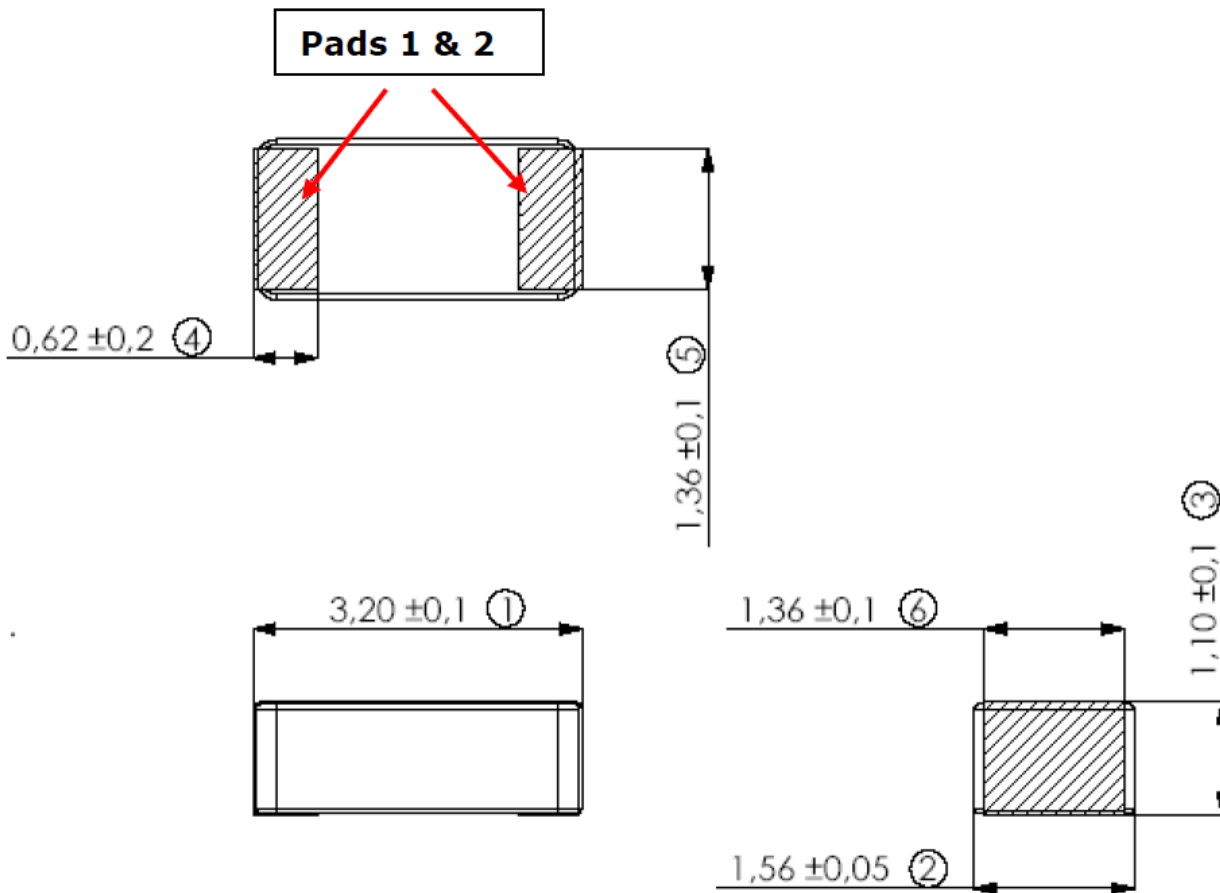

Antenna features		
No.	Terminal Name	Terminal Dimensions
1	Feed / Support	0.62 x 1.36 mm
2	Feed / Support	0.62 x 1.36 mm

Antenna is symmetrical.  
 Either of terminals 1 or 2 can be Feed / Support

Terminal Configuration, PCB Layout

W3154

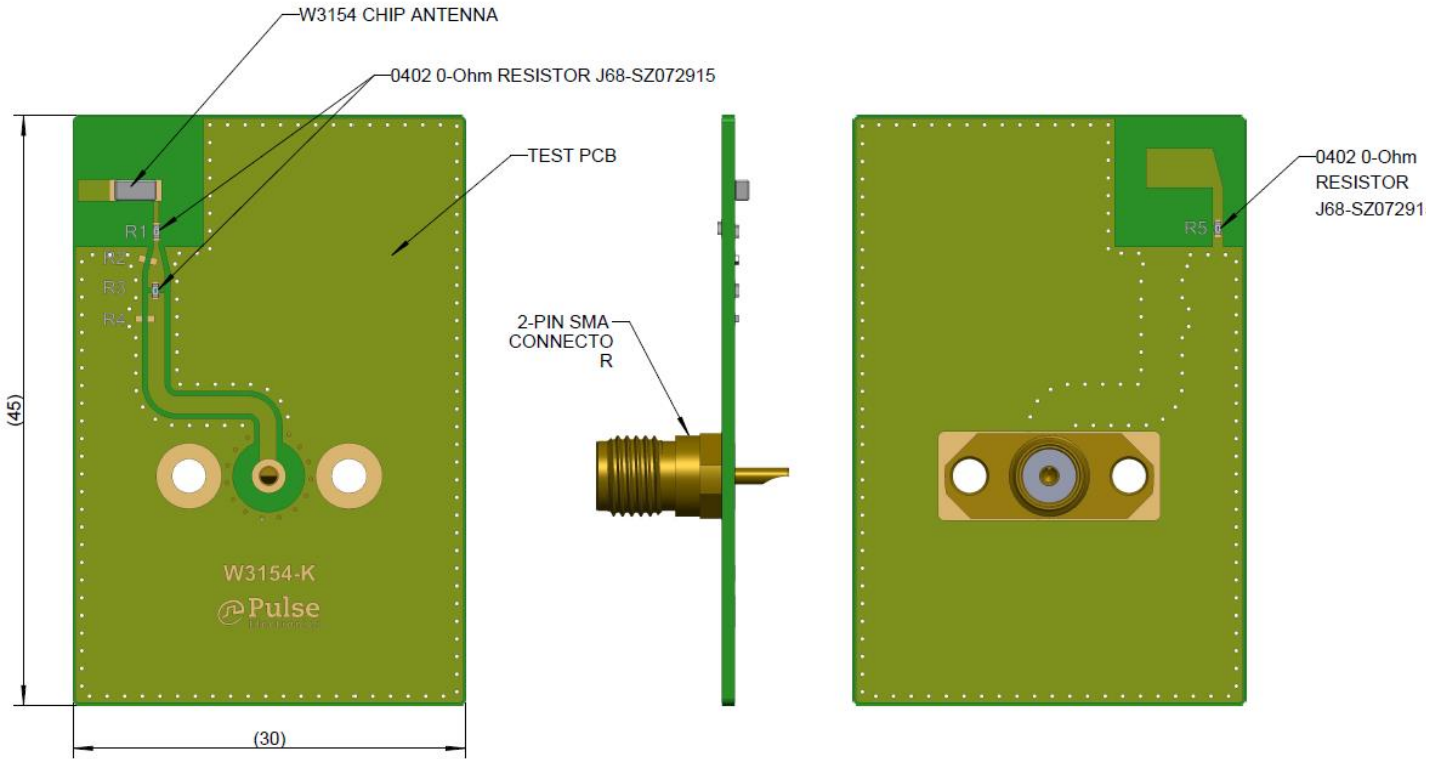
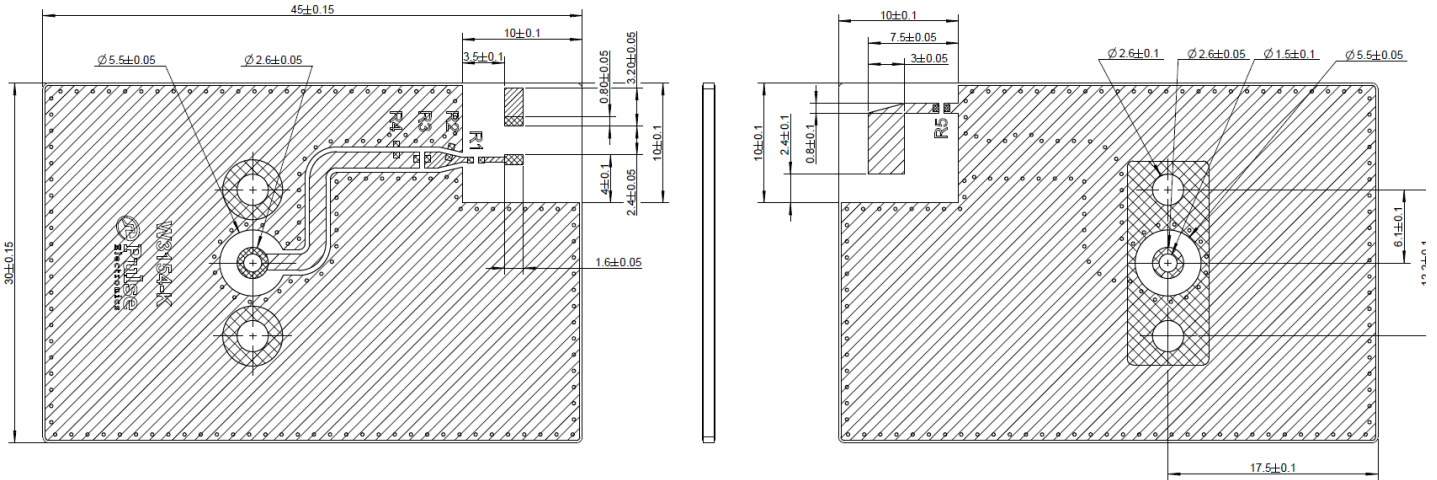

## Test Setup

### General / Chamber Setup

- Measured at Pulse Finland (MVG SGL24 Chamber)
- Measured with W3154-Kit



Measurement setup

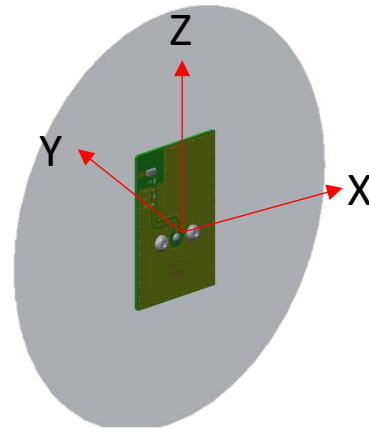

Chamber coordinate system

	Value	Component type
R1	0 - ohm	J68-SZ072915
R2	None	
R3	0 - ohm	J68-SZ072915
R4	None	
R5	0 - ohm	J68-SZ072915

Evaluation board matching component values

## Charts - VSWR

Test data

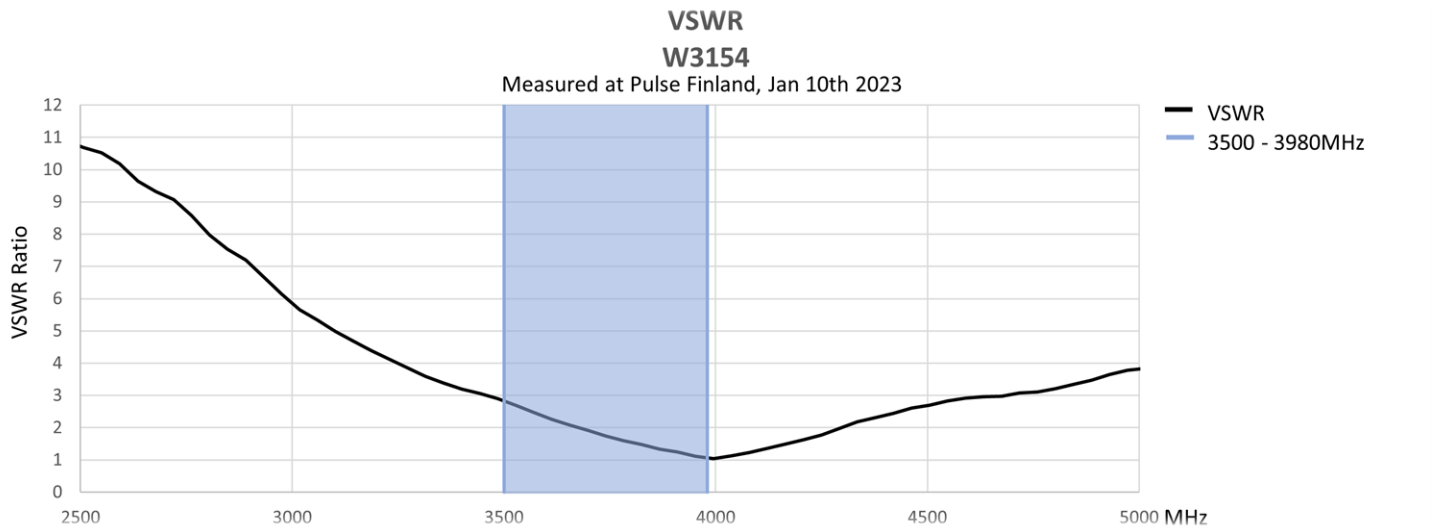

## Charts - Return loss

Test data

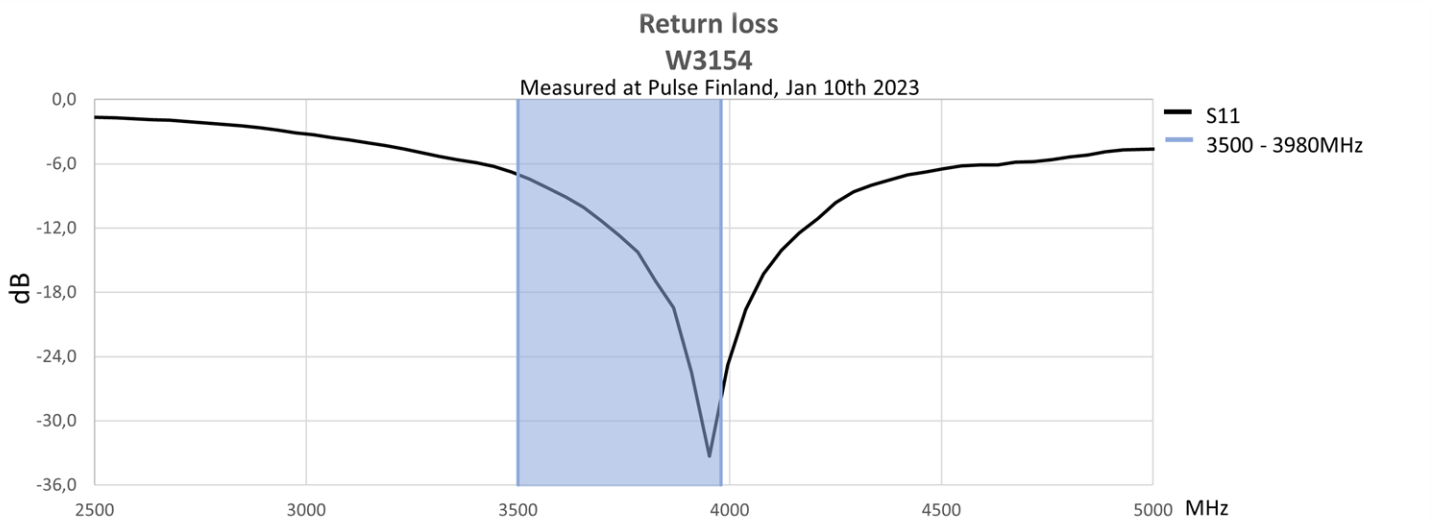

## Charts – Max Gain dBi

Test data

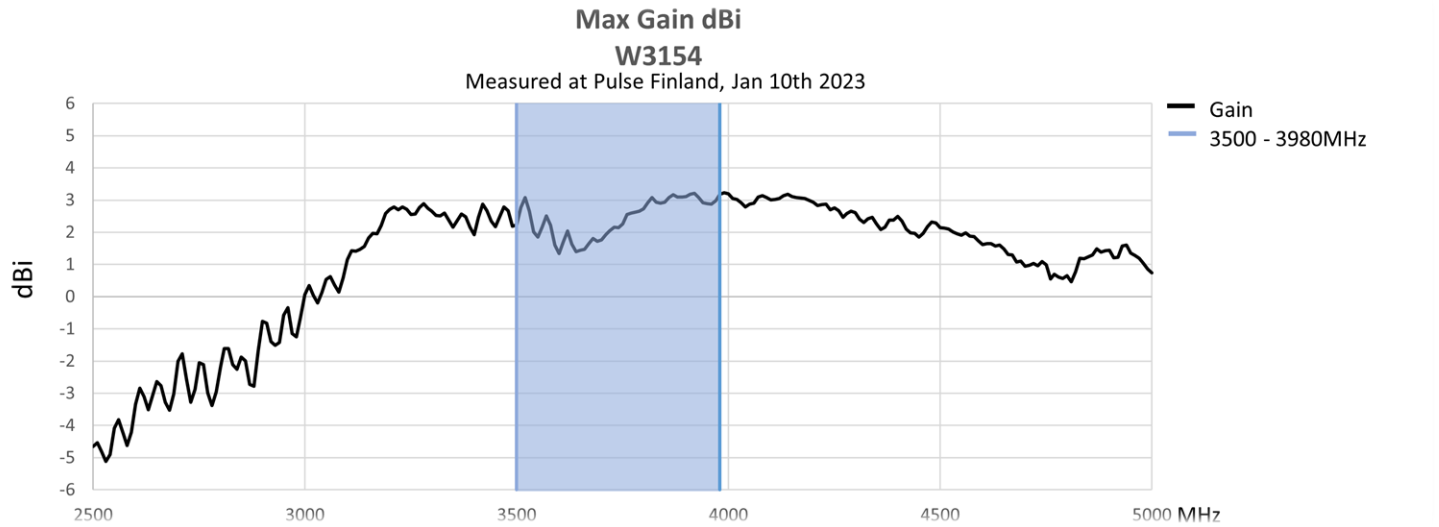

## Charts - Efficiency

Test data

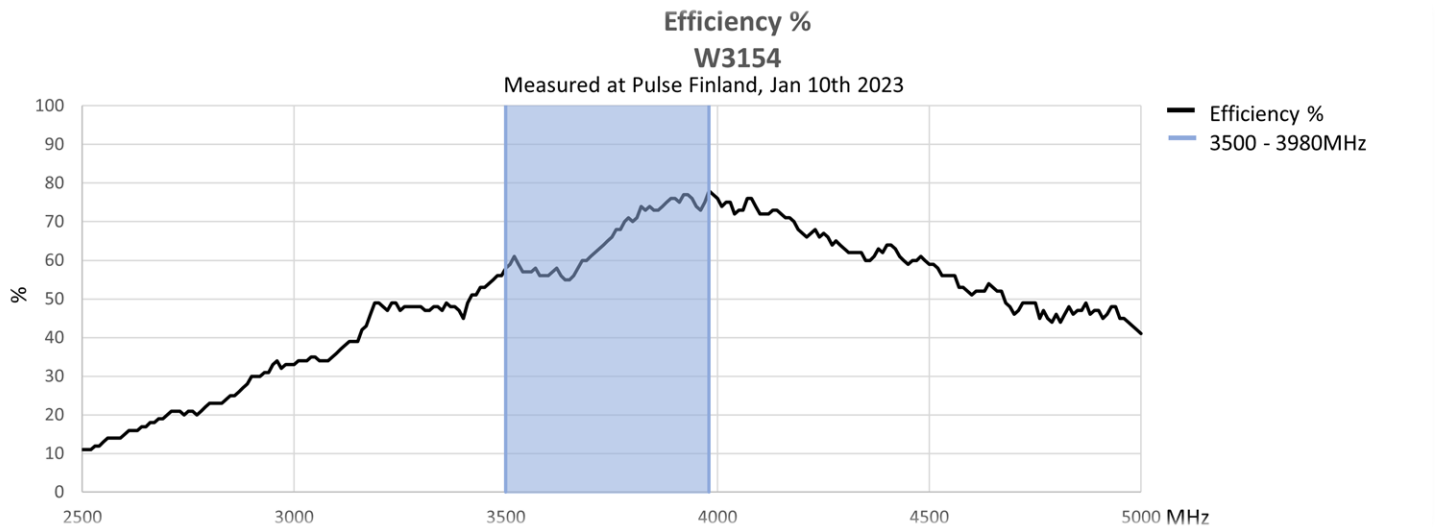

**Radiation Patterns**

**XZ-plane**

**YZ-plane**

Test data

- 3500.00 MHz 0.00 ° E Total
- 3750.00 MHz 0.00 ° E Total
- 3980.00 MHz 0.00 ° E Total

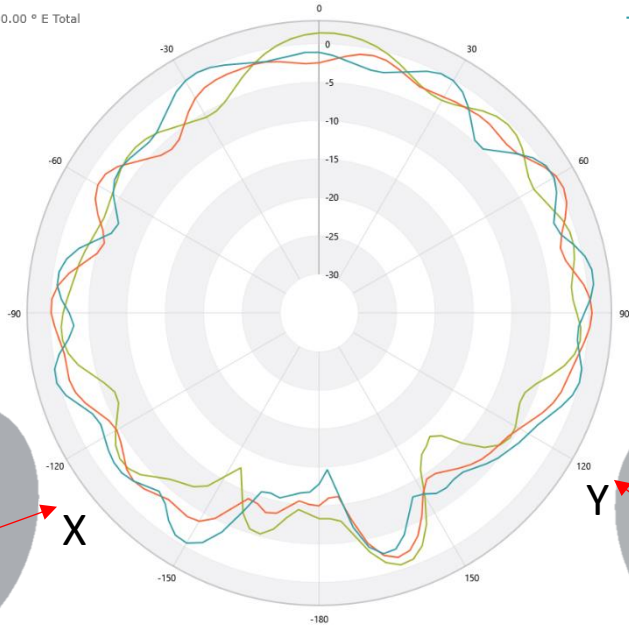

- 3500.00 MHz 90.00 ° E Total
- 3750.00 MHz 90.00 ° E Total
- 3980.00 MHz 90.00 ° E Total

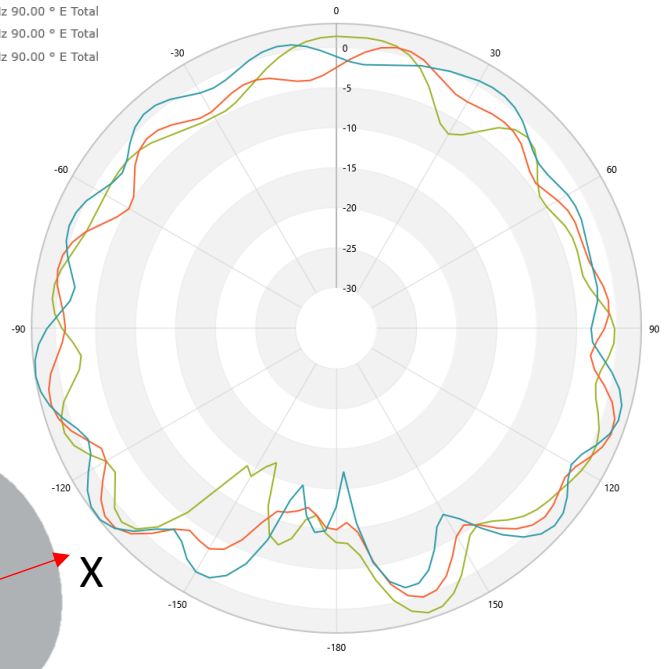

**XY-plane**

Test data

- 3500.00 MHz 90.00 ° E Total
- 3750.00 MHz 90.00 ° E Total
- 3980.00 MHz 90.00 ° E Total

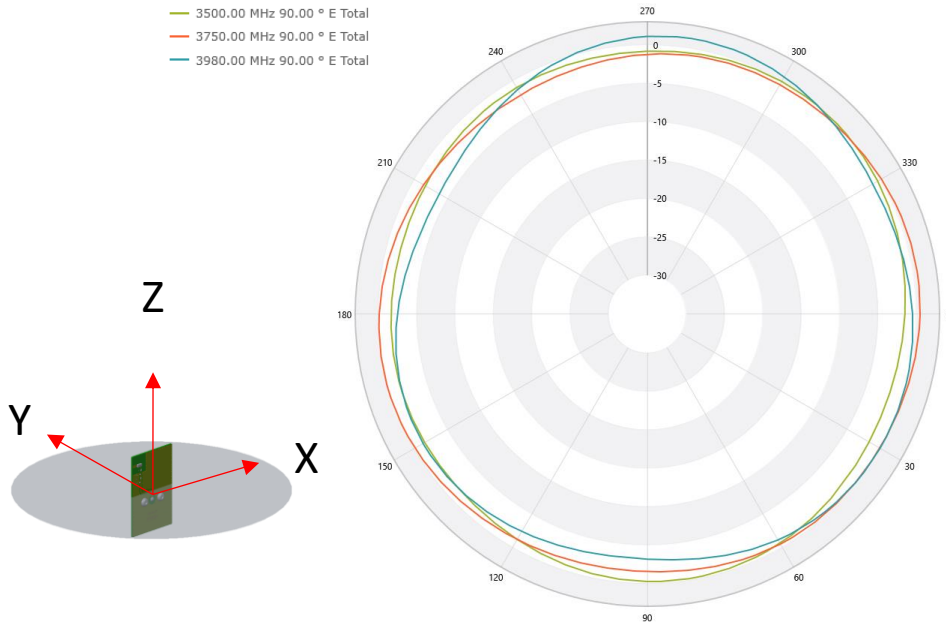

Tuning example

W3154

- Board size increased from 45 x 30 x 1 mm to 65 x 50 x 2 mm

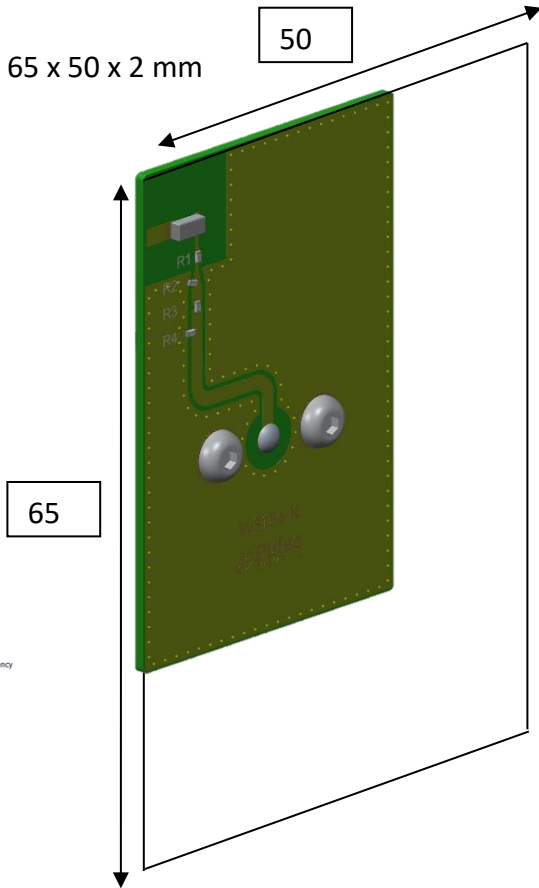
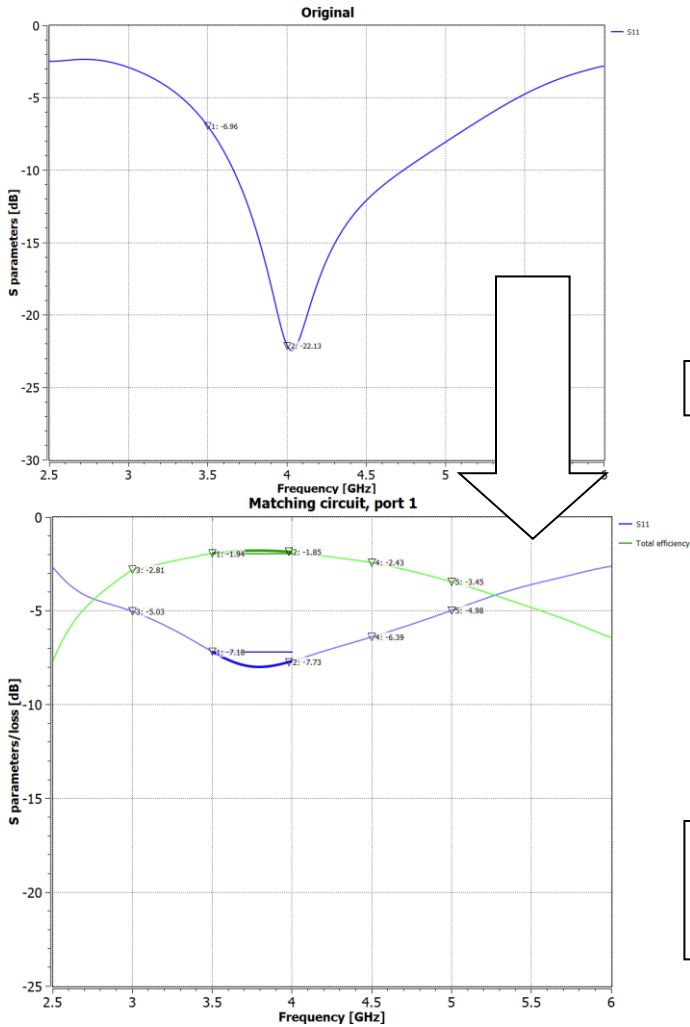

Note: simulation model results vary from actual real life measurement results.

	Value	Component type
R1	0 - ohm	J68-SZ072915
R2		None
R3	0 - ohm	J68-SZ072915
R4		None
R5	0 - ohm	J68-SZ072915



### Move resonance downward - topology

W3154

Try this configuration if resonance is too high.

Matching circuit generated from s-parameters by Optenni, using 2 components from Murata LQW15AN- and GJM15 series components.

R3 on eval board = Inductor L1  
R2 on eval board = Capacitor C1

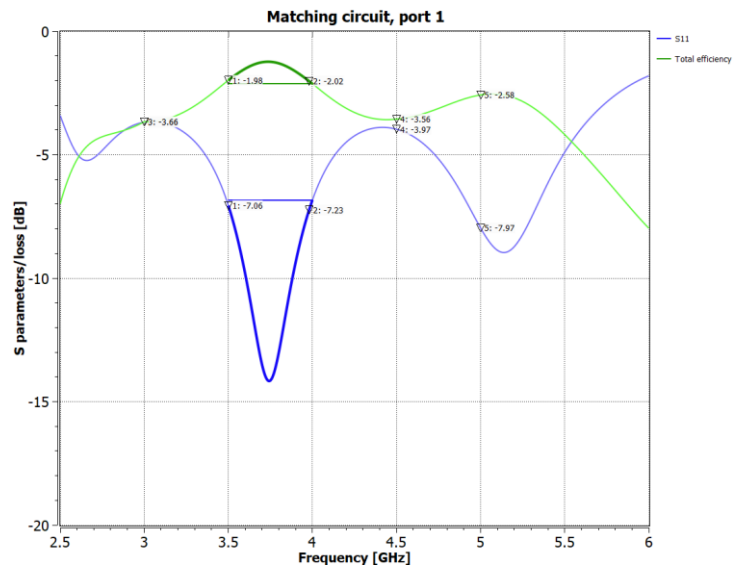
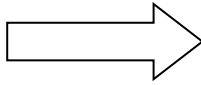
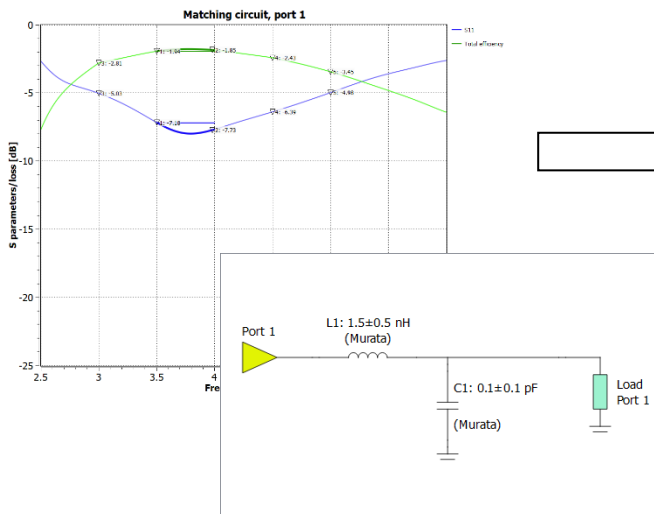

Increase capacitor C1 value to move resonance **downward**

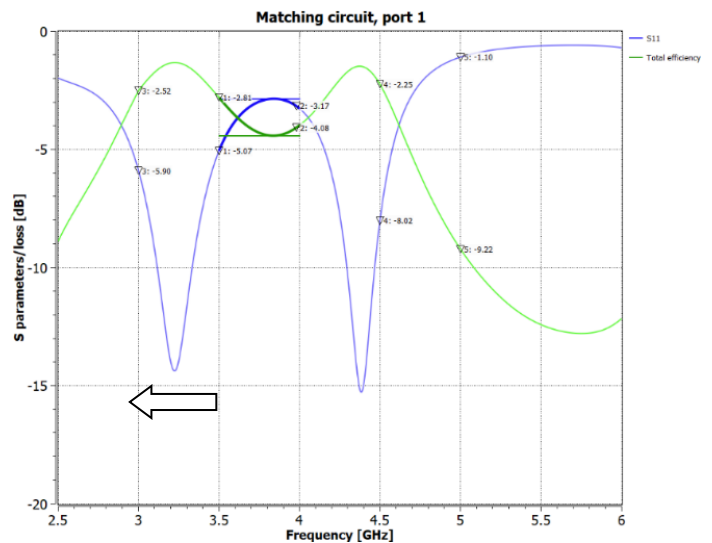
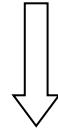

### Move resonance upward - topology

W3154

Try this configuration if the resonance is too low.

Matching generated from s-parameters by Optenni, using 2 components from Murata LQW15AN- and GJM15 series components

R4 on eval board = Capacitor C1

R3 on eval board = Inductor L1

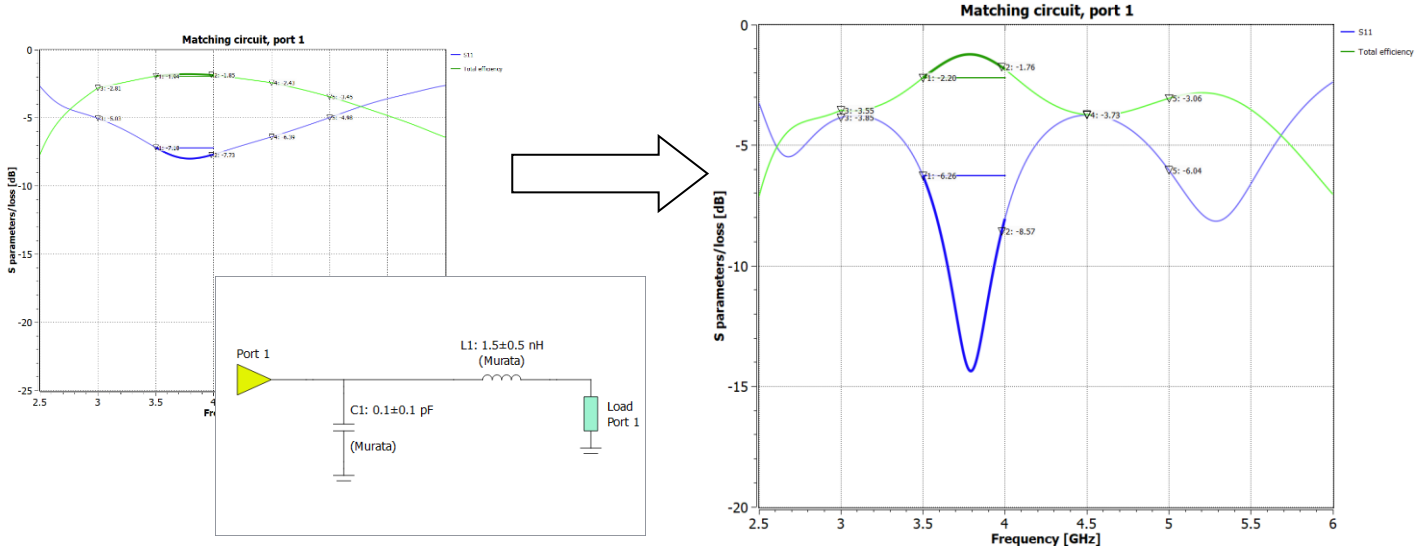

Increase capacitor C1 value to move resonance **upward**

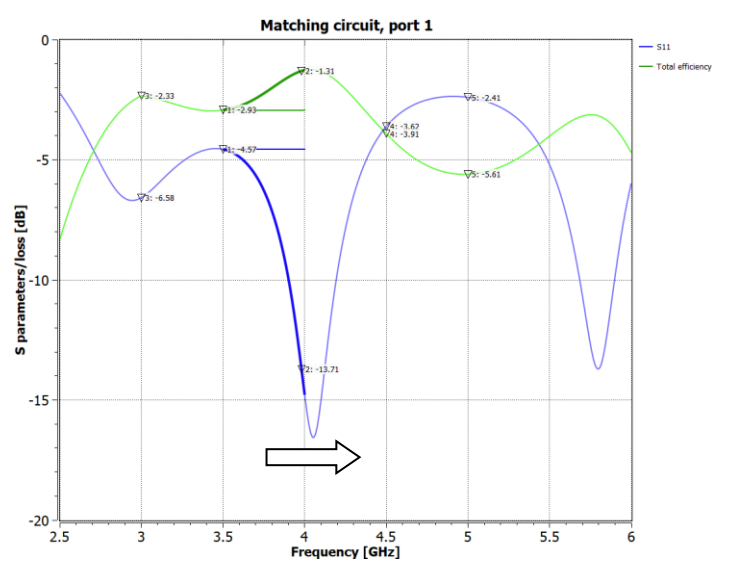

## Storage condition recommendation

W3154

### Storage time

Products should be used within 6 months from the day of manufacturers packaging even when they are stored under below mentioned conditions. Longer storage period may decrease the component solderability.

### Storage environmental conditions

To maintain solderability of Pulse ceramic products care must be taken to control the storage and use conditions:

- Do not store or use products in a corrosive atmosphere, especially where chloride, sulphur or sulfide, alkali or acid salts exist in the air. Corrosive gases may cause oxidation of electrodes and reduce solderability
- Keep temperature and humidity stable and do not exceed the below mentioned minimum and maximum conditions: Temperature: -10 to +30 Deg C  
Humidity: below 60% RH
- Do not store the products under direct sun light.

It is recommended to keep the products in manufacturers packing (tape&reel) until the time of assembly and soldering process. Air tight vacuum package is recommended in the conditions where it is know to be some corrosive gases.

### Handling

Do not touch the components with bare hands. Protective gloves must be used to prevent contamination of terminals which may cause reduced solderability. Do not touch or damage the silver plated surface by any sharp objects. Soft materials (plastic, wood etc.) must be used if tweezers or other tools are used to pick the components. Avoid any excess mechanical shock or vibration during storage and handling.

## Reflow soldering profile

W3154

	Method of heat transfer	Controlled hot air convection
1	Average temperature gradient in preheating	2.5 °C/s
2	Soak time	2-3 minutes
3	Max temperature gradient in reflow	3 °C/s
4	Time above 217 °C	Max 60 sec
5	Time above 230 °C	Max 50 sec
6	Time above 250 °C	Max 10 sec
7	Peak temperature in reflow	260 °C for 5 seconds
8	Temperature gradient in cooling	Max -5 °C/s

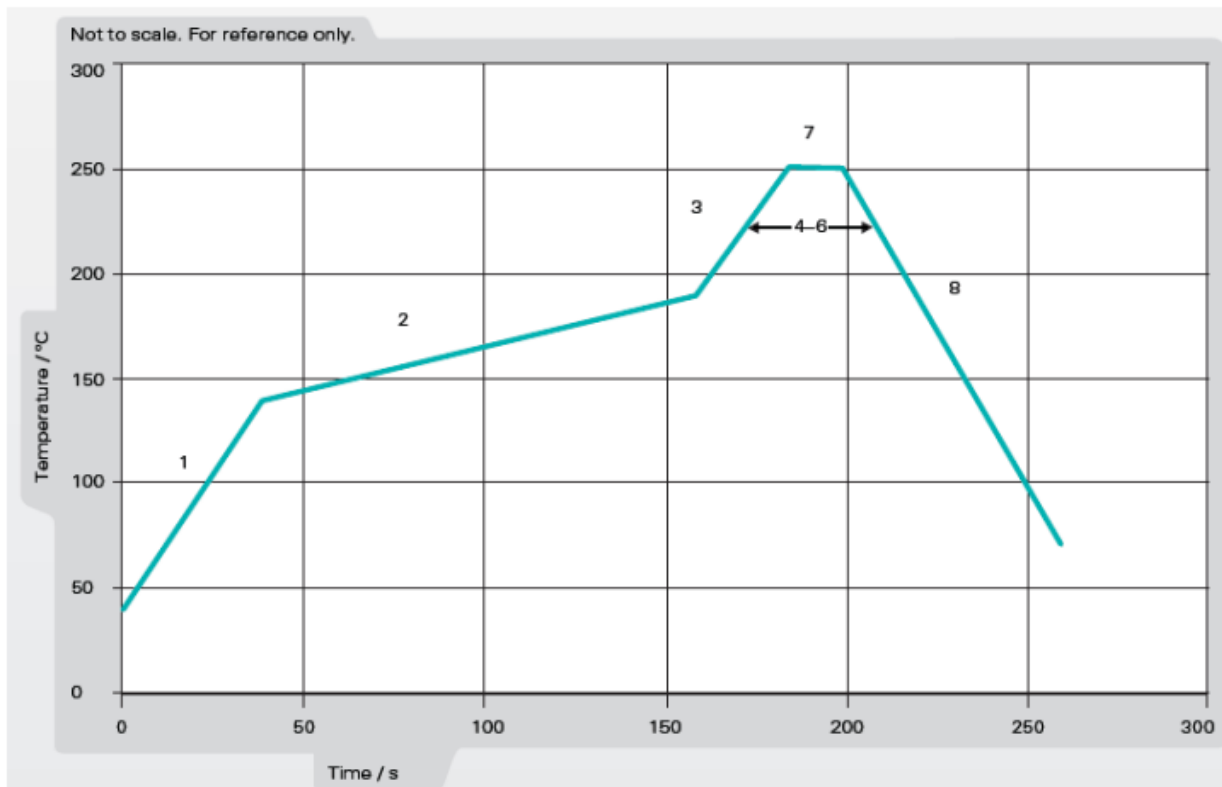
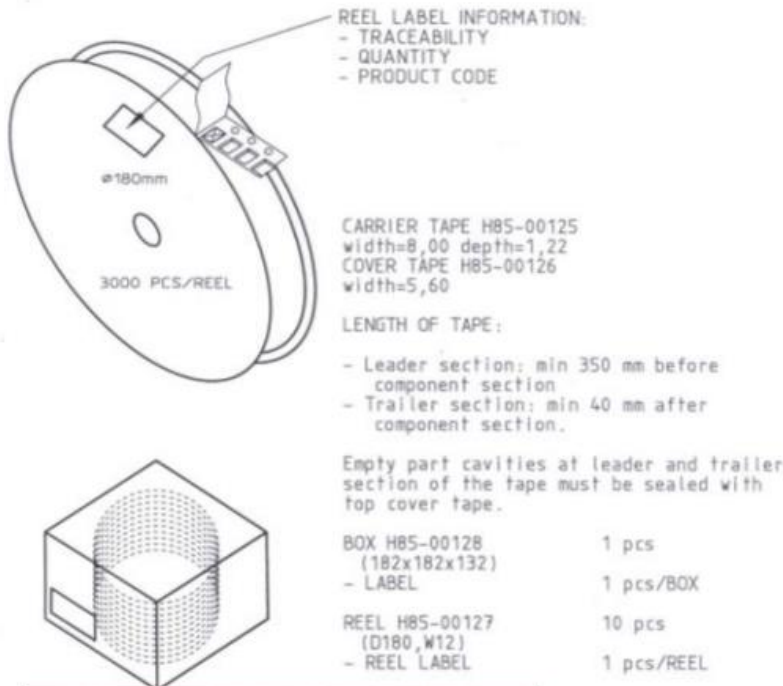

Figure 2. Maximum temperature profile recommendation for reflow soldering process

Packing

W3154

Tape and reel packing is used.  
 3000pcs antenna/reel, 10 reels/inbox, 2 inbox(60000pcs antenna)/outbox.



<b>LEVEL</b>
<b>NOT MOISTURE SENSITIVE</b>
<b>1</b>

These Devices do not require special storage conditions provided:

1. They are maintained at conditions equal to or less than 30°C and 85% RH.
2. They are solder reflowed at a peak body temperature which does not exceed 260°C.

Note: Level and body temperature defined by IPC/JEDEC J-STD-020

**For More Information:**

Americas - [antennas.us@pulseelectronics.com](mailto:antennas.us@pulseelectronics.com) | Europe – [antennas.eu@pulseelectronics.com](mailto:antennas.eu@pulseelectronics.com) | Asia – [antennas.as@pulseelectronics.com](mailto:antennas.as@pulseelectronics.com) | Questions? +1-800-ANTENNA  
 Performance warranty of products offered on this data sheet is limited to the parameters specified. Data is subject to change without notice. Other brand and product names mentioned herein may be trademarks or registered trademarks of their respective owners. © Copyright , 2020. Pulse Electronics, Inc. All rights reserved.