

Z109REG2-1

HIGH PERFORMANCE UNIVERSAL CONVERTER, PROGRAMMABLE VIA MICROUSB/APP

Highlights

- Power Supply Vac/dc
- Power supply, 2-wire technique
- Selectable input V, mA, Ohm, thermocouple (TC), thermoresistance (RTD)
- Selectable output mA (active/passive), V
- Alarm relay output (spst) / strobe input to enable analog output
- Sampling frequency from 240 sps (@11bit+sign resolution) to 15 sps (@15 bit+sign resolution)
- Isolation 1.500 Vac at 3-ways power supply / input / output
- Setting via DIP switches, software or APP
- Micro USB connector (front side)
- Operating temperature -10...+60°C
- UL Certification

Z109REG2-1 is an advanced universal converter able to manage all analog signals (mA, V, PT100, Pt1000, Pt500, Ni100, TCs, Ohm) and convert / isolate it into mA/V standard signals.

The device can be configured through dip-switches, PC software, handheld device or via mobile app. A digital contact is available as ALARM or STROBE (multiplexing). A 3-way galvanic isolation among Power supply // input // output circuits assures the integrity of your datas.

The module has a Micro USB connector on the front side and can be configured by software or specific App for Android devices setting: beginning and end scale, additional input types, square root extraction, filter, burn-out etc.



Z109REG2-1



HIGH PERFORMANCE UNIVERSAL CONVERTER, PROGRAMMABLE VIA MICROUSB/APP

TECHNICAL DATA

GENERAL DATA

Power Supply	10..40 Vdc; 19..28 Vac
Power Transducers	Active input @ 2 wires (min 20 Vdc)
Power Consumption	2,5 W (max) - 1,6 W (24 Vdc, 20 mA)
Isolation	3.750 Vac (power supply / input / output)
Protection	Against pulse overvoltages: 400 W /ms
Protection degree	IP20
LED status indicators	Power Supply - Error - Alarm
Response time	35 ms (11 bit)..140 ms (16 bit) 35
Interfaces	Micro USB
Accuracy class	0,10%
Thermal drift	0.01%/K
Linearity	0,05% / 0.4%
Setting	DIP switch - Software (EASY SETUP) - App (EASY SETUP)
Operating temperature	-20..+60°C
Dimension	17,5 x 100 x 112 mm
Connessioni	Screw removable terminals 2,5 mm2
Enclosure	Nylon 6 with 30% fiber glass
Mounting	Guida DIN 35 mm (IEC/EN 60175)
Weight	200 g
Approvals	CE, UL
Norms	EN 61000-6-4, EN 61000-6-2, EN 61010-1

INPUT DATA

Channels	1 analogico, 1 strobe
Type	<ul style="list-style-type: none"> VOLTAGE (mV, V): Bipolar from 75 mV to 20 V, resolution 15 bit + sign CURRENT (mA): Bipolar up to 20 mA, resolution 1 μA RTD: Pt100, Pt500, Pt1000, Ni100, KTY81, KTY84, NTC; 3-4 wires measure; scalw: -200..600 °C, resolution 0,1°C THERMOCOUPLE: Type J, K, R, S, T, E, B, N, Resolution 2,5 μV POTENTIOMETER: 500 Ω ..10 kΩ RHEOSTAT: 500 Ω ..25 kΩ STROBE: Alternative to output relay

OUTPUT DATA

Channels	1 analog, 1 relay output
Type	<ul style="list-style-type: none"> VOLTAGE (V): 4 scales: 0/1..5V, 0/2..10V, Min load resistance: 2 kΩ CURRENT (mA): 2 scales: 0/4..20 mA, Max load resistance: 600 Ω RELAY: alternative to strobe input NC / NO in case alarm

ORDER CODES

Code	Description
Z109REG2-1	High performance universal converter, programmable via MicroUSB/App, 9..40 Vdc/19..28 Vac
CU-A-MICROB	USB-A Micro USB-B 5 P plug cable
CU-A-MICRO-OTG	Micro USB OTG to USB Type A (female) Adapter Cable
EASY SETUP	Plug&Play software suite for SENECA programmable instruments
EASY SETUP APP	App iOS / Android EASY SETUP suite
Z-POWER-115-15VA	DIN rail 19 Vac transformer, 115 / 15 VA with thermofuse
Z-POWER-230-15VA	DIN rail 19 Vac transformer, 230 / 15 VA with thermofuse
Z-POWER-230-25VA	DIN rail 19 Vac transformer, 230 / 25 VA with thermofuse
Z-SUPPLY	Single-phase switching power supply 24V @ 1.5A
Z-SUPPLY	Alimentatore switching monofase 24V @ 1,5 A

SIGNAL / ISOLATION DIAGRAM

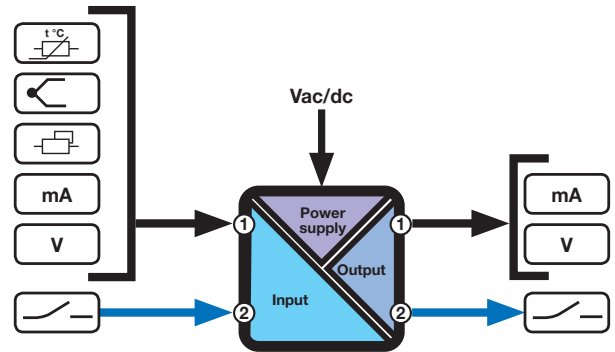

APPLICATION SCHEME

ANALOG SIGNAL CONVERSION AND RE-TRANSMISSION WITH RELAY OUTPUT

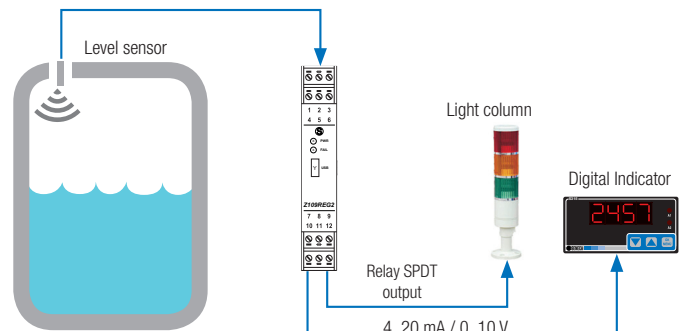

MULTIPLEXING AND PLC SIGNAL RE-TRANSMISSION

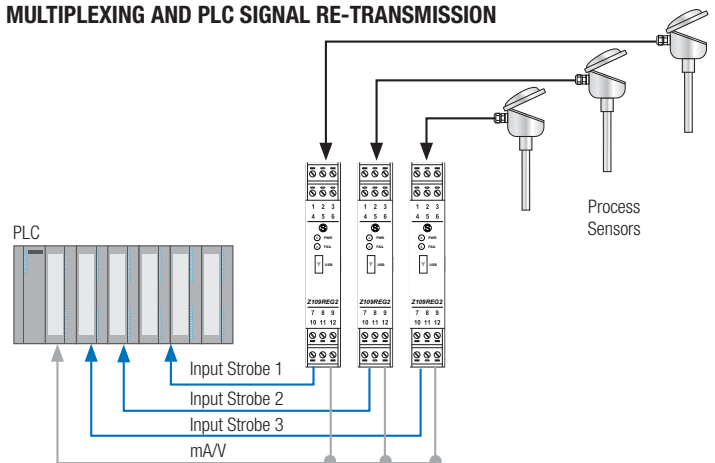

SETTING BY USB INTERFACE

