

**Food & Beverage Hygienic, PVC
Extension Cable
RKH4-5-RSH4/TFE**

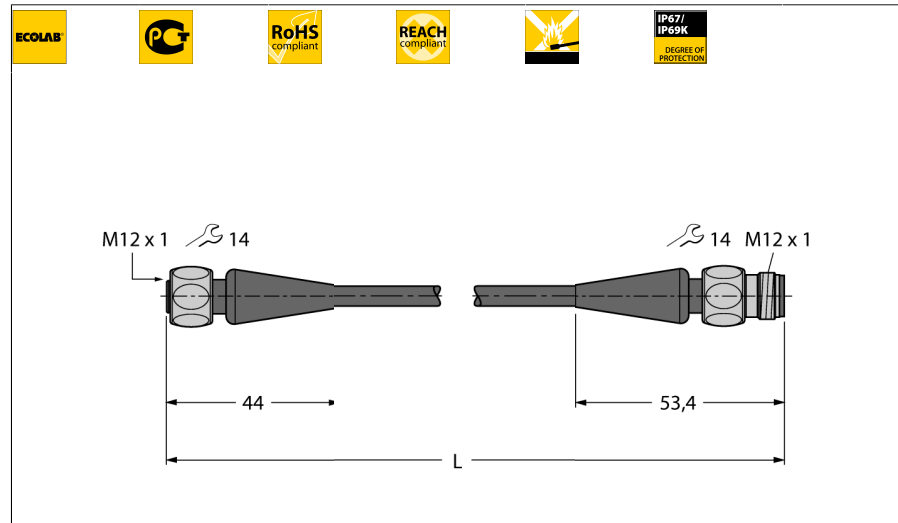

- M12 female connector, straight, 3-pin
- Stainless steel coupling nut/screw
- M12 male connector, straight, 3-pin
- Sheath material: PVC
- Sheath color: gray RAL 7040
- Resistant to acids and alkalis
- Resistant to oils and chemicals
- Flame-retardant acc. to DIN EN 60332 1-2, DIN EN 60332 2-2, VDE 0482 332-1-2, VDE 0482 332-2-2
- Approvals: cULus, Gost, Ecolab
- RoHS and REACH compliant
- Protection classes IP67, IP69K
- Cable length: 5.0 m

Type designation	RKH4-5-RSH4/TFE
Ident no.	6934467
Connector A side	Female connector, M12 ♂ 1, Straight
Number of pins	3
Contacts	Brass, CuZn, Gold-plated
Contact carriers	Plastic, PP, Gray
Grip	Plastic, PP, Gray
Coupling nut/screw	Stainless steel, V4A
Seal	Plastic, FPM/FKM
Protection class	IP67, IP69K, A + B side screwed together
Mechanical lifespan	> 100 Mating cycles
Pollution degree	3
Tightening torque	0.8 ... 1 Nm (observe max. torque of counter piece!)
Connector B side	Connector, M12 x 1, Straight
Number of pins	3 pins
Contacts	brass, CuZn, Gold-plated
Contact carriers	Plastic, PP, Gray
Grip	plastic, PP, gray
Coupling nut/screw	Stainless steel, V4A
Protection class	IP67, IP69K, Only when screwed tight
Mechanical lifespan	> 100 Mating cycles
Pollution degree	3
Tightening torque	0.8 ... 1 Nm (observe max. torque of counter piece!)
General data	
Cable diameter	4.2 ± 0.20mm
Cable length	5 m
Cable quality	PVC
Cable color	Gray
Core insulation	PVC
Core colors	BN, BU, BK
Core cross-section	3x0.34mm ²
Arrangement of strands	19x0.15 mm

Cable Cross-section

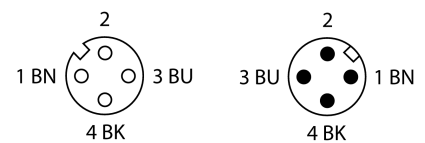
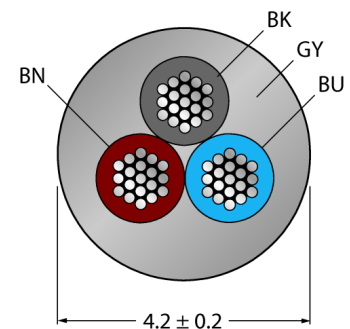

Circuit Diagram

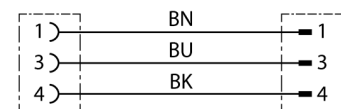

Electrical features at +20 °C	
Current	4 A
Rated voltage	250 V
Test voltage	1500 V

**Food & Beverage Hygienic, PVC
Extension Cable
RKH4-5-RSH4/TFE**

TURCK

Industrial
Automation

Mechanical and chemical properties

Bending radius (stationary laying)	> 3 x Ø
Bending radius (flexible use)	> 10 x Ø
Ambient temperature	
Stationary	-25...+80°C
In motion	0...+80°C