

Ultra High Precision Z-Foil Through-Hole Resistor with TCR of $\pm 0.05 \text{ ppm}/^\circ\text{C}$, Tolerance of $\pm 0.005 \%$ (50 ppm), Load Life Stability of $\pm 0.005 \%$

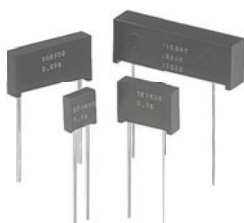

INTRODUCTION

The Bulk Metal® Foil resistor is based on a special thermo-metallic stress concept wherein a proprietary bulk metal cold rolled foil is cemented to a ceramic substrate. It is then photoetched into a resistive pattern. Then it is laser adjusted to any desired value and tolerance. Because the metals used are not drawn, wound or mistreated in any way during manufacturing process, the Bulk Metal Foil resistor maintains all its design, physical and electrical characteristics while winding of wire or sputtering does not. Z foil resistors achieve maximum stability and near-zero TCR. These performance characteristics are built-in for every unit, and do not rely on screening or other artificial means for uniform performance.

The stability of a resistor depends primarily on its history of exposures to temperature. Stability is affected by:

1. Reversible changes in the ambient temperature and heat from adjacent components (defined by the Temperature Coefficient of Resistance, or TCR)
2. Short-term steady-state self-heating (defined by Power TCR or PCR)
3. Irreversible destabilizing shock of suddenly-applied power
4. Long-term exposure to applied power (load-life stability)
5. Repetitive stresses from being switched on and off

In very high-precision resistors, these effects must be taken into account to achieve high stability with changes in load (Joule Effect) and ambient temperature.

Vishay Foil Resistors' new Z-Foil technology provides an order of magnitude reduction in the Bulk Metal Foil element's sensitivity to temperature changes - both external and internal. This technology provides TCR of $\pm 0.05 \text{ ppm}/^\circ\text{C}$ nominal (instrument range: 0°C to $+60^\circ\text{C}$), $\pm 0.2 \text{ ppm}/^\circ\text{C}$ nominal (military range: -55°C to $+125^\circ\text{C}$, $+25^\circ\text{C}$ ref), and a PCR of 5 ppm at rated power.

In order to take full advantage of this TCR improvement, it is necessary to take into account the differences in the resistor's response to each of the above-mentioned effects. The Z series has been developed to successfully deal with these factors.

* Pb containing terminations are not RoHS compliant, exemptions may apply

** See PMO page 5

FEATURES

- **Temperature coefficient of resistance (TCR):**
 - $\pm 0.05 \text{ ppm}/^\circ\text{C}$ nominal (0°C to $+60^\circ\text{C}$)
 - $\pm 0.2 \text{ ppm}/^\circ\text{C}$ nominal (-55°C to $+125^\circ\text{C}$, $+25^\circ\text{C}$ ref.) (see table 1)
- Rated power: to 1 W at $+125^\circ\text{C}$ (see table 2)
- Resistance tolerance: to $\pm 0.005 \%$ (50 ppm)
- Load life stability: $\pm 0.005 \%$ at 70°C , 2000 h or $\pm 0.015 \%$ at 70°C , 10000 h (see table 4)
- Resistance range: 5Ω to $600 \text{ k}\Omega$
- Vishay Foil Resistors are not restricted to standard values; specific "as required" values can be supplied at no extra cost or delivery (e.g. 1K2345 vs. 1K)
- Total accumulated change in resistance over life (EOL) or Total Error Budget $< 0.1 \%$ (or better with PMO)**
- Electrostatic discharge up to 25 000 V
- Non-inductive, non-capacitive design
- Rise time: 1 ns effectively no ringing
- Current noise: $\leq 0.010 \mu\text{V}_{\text{RMS}}/\text{V}$ of applied voltage ($< -40 \text{ dB}$)
- Thermal EMF: $0.05 \mu\text{V}/^\circ\text{C}$ typical
- Voltage coefficient: $< 0.1 \text{ ppm}/\text{V}$
- Low inductance: $< 0.08 \mu\text{H}$ typical
- Thermal stabilization time $< 1 \text{ s}$ (to reach within 10 ppm of steady state value)
- Pattern design minimizing hot spots
- Terminal finish: lead (Pb)-free or tin/lead alloy
- Matched sets are available per request (TCR tracking: to $0.5 \text{ ppm}/^\circ\text{C}$)
- Prototype quantities available in just 5 working days or sooner. For more information, please contact foil@vishaypg.com



RoHS*
COMPLIANT

TABLE 1 - NOMINAL TCR AND MAX. SPREAD
(-55°C to $+125^\circ\text{C}$, $+25^\circ\text{C}$ ref.)

VALUE	STANDARD TOLERANCE	NOMINAL TCR AND MAX. SPREAD (ppm/°C)
100 Ω to 600 K Ω	$\pm 0.005 \%$	$\pm 0.2 \pm 0.6$
80 Ω to $< 100 \Omega$	$\pm 0.005 \%$	$\pm 0.2 \pm 0.8$
50 Ω to $< 80 \Omega$	$\pm 0.01 \%$	$\pm 0.2 \pm 1.0$
25 Ω to $< 50 \Omega$	$\pm 0.01 \%$	$\pm 0.2 \pm 1.3$
10 Ω to $< 25 \Omega$	$\pm 0.02 \%$	$\pm 0.2 \pm 1.6$
5 Ω to $< 10 \Omega$	$\pm 0.05 \%$	$\pm 0.2 \pm 2.3$

FIGURE 1 - NOMINAL RESISTANCE/TEMPERATURE CURVE
(for more details, see table 1)

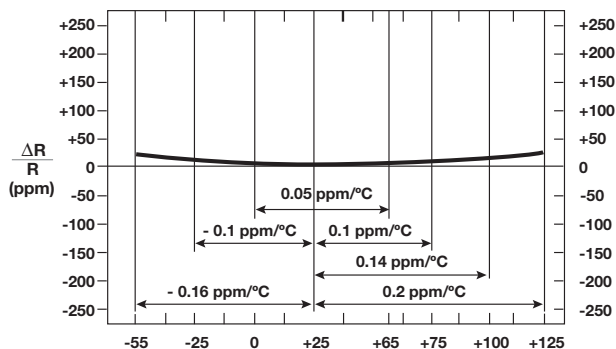

Note

- The TCR values for $< 100 \Omega$ are influenced by the termination composition and result in deviation from this curve

FIGURE 2 - POWER DERATING CURVE

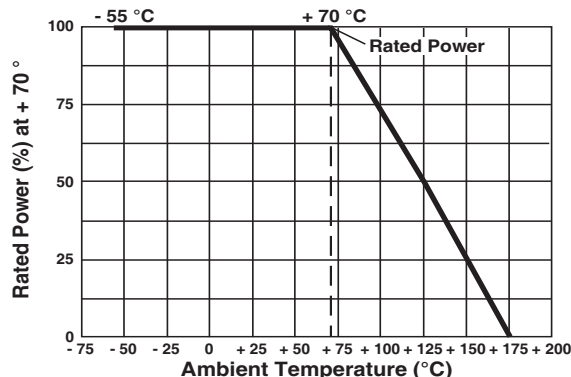
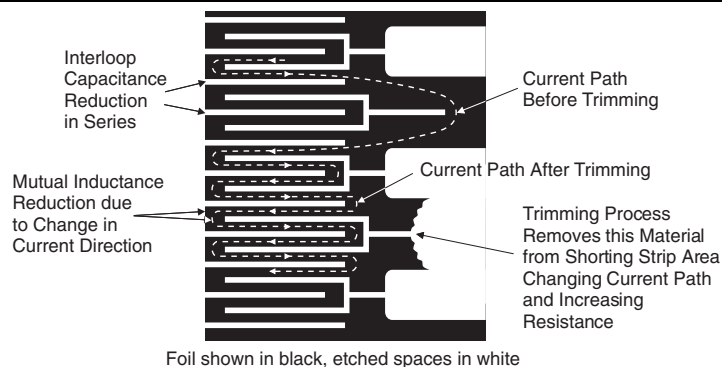

FIGURE 3 - TRIMMING TO VALUES (conceptual illustration)



Note

To acquire a precision resistance value, the Bulk Metal® Foil chip is trimmed by selectively removing built-in “shorting bars.” To increase the resistance in known increments, marked areas are cut, producing progressively smaller increases in resistance. This method reduces the effect of “hot spots” and improves the long-term stability of the Vishay Foil resistor.

FIGURE 4 - THROUGH-HOLE STYLE (>29 YEARS)

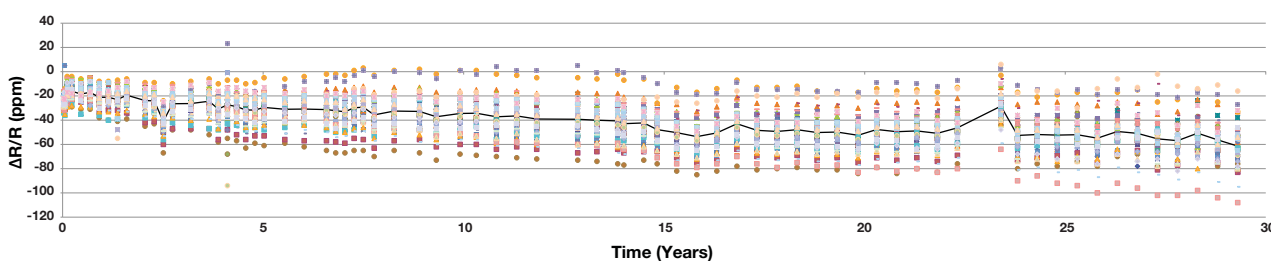

TABLE 2 - MODEL SELECTION

MODEL NUMBER	RESISTANCE RANGE (Ω) ⁽²⁾	MAXIMUM WORKING VOLTAGE	AMBIENT POWER RATING		AVERAGE WEIGHT (g)	DIMENSIONS	
			at + 70 °C	at + 125 °C		INCHES	mm
Z201 (Z201L) ⁽¹⁾	5Ω to 100K	300	0.6 W	0.3 W	0.6	W: 0.105 ± 0.010 L: 0.300 ± 0.010 H: 0.326 ± 0.010 ST: 0.010 min. SW: 0.035 ± 0.010 LL: 1.000 ± 0.125 LS: 0.150 ± 0.005 ⁽¹⁾	2.67 ± 0.25 7.62 ± 0.25 8.28 ± 0.25 0.254 min. 0.89 ± 0.13 25.4 ± 3.18 3.81 ± 0.13
Z204	5Ω to 200K	350	1.0 W	0.5 W	1.4	W: 0.160 max. L: 0.575 max. H: 0.413 max. ST: 0.035 ± 0.005 SW: 0.050 ± 0.005 LL: 1.000 ± 0.125 LS: 0.400 ± 0.020	4.06 max. 14.61 max. 10.49 max. 0.889 ± 0.13 1.27 ± 0.13 25.4 ± 3.18 10.16 ± 0.51
Z205	5Ω to 300K	350	1.5 W	0.75 W	1.9	W: 0.160 max. L: 0.820 max. H: 0.413 max. ST: 0.035 ± 0.005 SW: 0.050 ± 0.005 LL: 1.000 ± 0.125 LS: 0.650 ± 0.020	4.06 max. 20.83 max. 10.49 max. 0.889 ± 0.13 1.27 ± 0.13 25.4 ± 3.18 16.51 ± 0.51
Z206	5Ω to 600K	500	2.0 W up to 400K 1.0 W over 400K	1.0 W 0.5 W	4.0	W: 0.260 max. L: 1.200 max. H: 0.413 max. ST: 0.035 ± 0.005 SW: 0.050 ± 0.005 LL: 1.000 ± 0.125 LS: 0.900 ± 0.020	6.60 max. 30.48 max. 10.49 max. 0.889 ± 0.13 1.27 ± 0.13 25.4 ± 3.18 22.86 ± 0.51

Note

⁽¹⁾ 0.200" (5.08 mm) lead spacing available - specify Z201L instead of Z201.

⁽²⁾ for non standard values please contact Application Engineering Department at foil@vishaypg.com

FIGURE 5 - STANDARD IMPRINTING AND DIMENSIONS

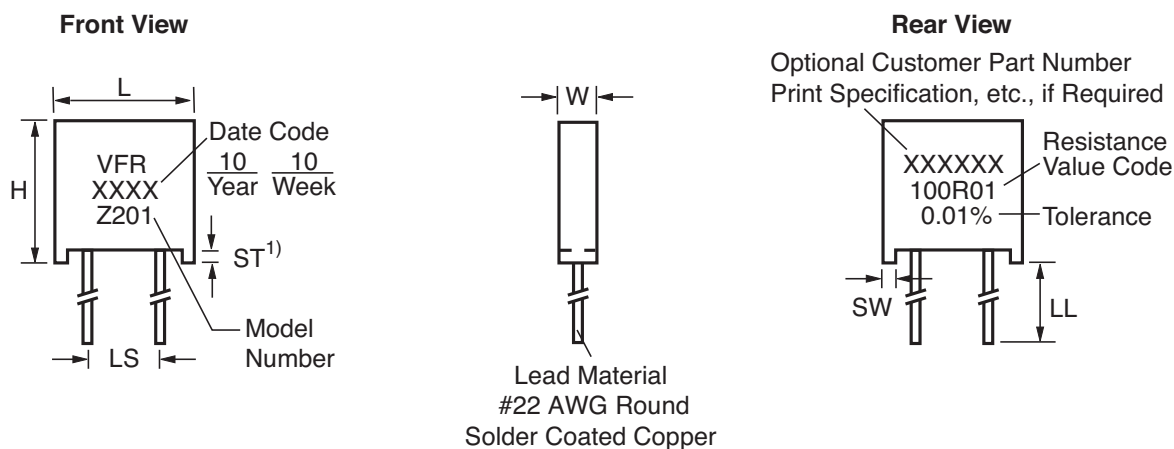

Note

1. The standoffs shall be so located as to give a lead clearance of 0.010" minimum between the resistor body and the printed circuit board when the standoffs are seated on the printed circuit board. This is to allow for proper cleaning of flux and other contaminants from the unit after all soldering processes.

TABLE 3 - ENVIRONMENTAL PERFORMANCE COMPARISON

	MIL-PRF-55182 CHAR J	Z SERIES TYPICAL ΔR	Z SERIES MAXIMUM ΔR
Test Group I			
Thermal shock, 5 x (- 65 °C to + 150 °C)	± 0.2 %	± 0.002 % (20 ppm)	± 0.01 % (100 ppm)
Short time overload, 6.25 x rated power	± 0.2 %	± 0.003 % (30 ppm)	± 0.01 % (100 ppm)
Test Group II			
Resistance temperature characteristics	± 25 ppm/°C	± 0.05 ppm/°C	see table 1
Low temperature storage (24 h at - 65 °C)	± 0.15 %	± 0.002 % (20 ppm)	± 0.01 % (100 ppm)
Low temperature operation (45 min, rated power at - 65 °C)	± 0.15 %	± 0.002 % (20 ppm)	± 0.01 % (100 ppm)
Terminal strength	± 0.2 %	± 0.002 % (20 ppm)	± 0.01 % (100 ppm)
Test Group III			
DWV	± 0.15 %	± 0.002 % (20 ppm)	± 0.01 % (100 ppm)
Resistance to solder heat	± 0.1 %	± 0.005 % (50 ppm)	± 0.01 % (100 ppm)
Moisture resistance	± 0.4 %	± 0.01 % (100 ppm)	± 0.05 % (500 ppm)
Test Group IV			
Shock	± 0.2 %	± 0.002 % (20 ppm)	± 0.01 % (100 ppm)
Vibration	± 0.2 %	± 0.002 % (20 ppm)	± 0.01 % (100 ppm)
Test Group V			
Life test at rated power / + 125°C			
2000 h	± 0.5 %	± 0.005 % (50 ppm)	± 0.015 % (150 ppm)
10 000 h	± 2.0 %	± 0.015 % (150 ppm)	± 0.05 % (500 ppm)
Test Group Va			
Life test at 2 x rated power / + 70°C, 2000 h	± 0.5 %	± 0.005 % (50 ppm)	± 0.015 % (150 ppm)
Test Group VI			
High temperature exposure (2000 h at + 175 °C)	± 2.0 %	± 0.05 % (500 ppm)	± 0.1 % (1000 ppm)
Test Group VII			
Voltage coefficient	5 ppm/V	< 0.1 ppm/V	< 0.1 ppm/V

STANDARD OPERATIONS AND TEST CONDITIONS

A. Standard Test Operations:

By 100 % Inspection

- Short-time overload (6.25 x rated power for 5 s)
- Resistance - tolerance check
- Visual and mechanical

By Sample Inspection

- TCR
- Environmental tests per table 3 on a quarterly basis to establish performance by similarity

B. Standard Test Conditions:

- Lead test point: 0.5" (12.7 mm) from resistor body
- Temperature: + 23 °C ± 2 °C
- Relative humidity: per MIL-STD-202

LONG-TERM STABILITY

Some process controls are not very critical but many, many are—particularly when a process is operating near a tipping point where it could get out of control quickly if not well monitored.

In process control applications, entire production batches have been lost or suffered reduced reliability when critical parameters were not kept within narrow limits. One thing that can cause this to happen is changes in the precision resistor over time. Reference points in the control process thus become less and less reliable. Repeatability of the process from batch to batch begins to drift. The process is changing while the monitors appear to be holding it within specified limits because the sense resistor is producing a different output voltage than it was in previous runs for the same sensor output. So the process appears to be under control when, in reality, it is experiencing an undetected drift.

Long-term stability is thus one of the considerations that drive the selection of which resistor technology to use in the application.

But the typical permanent resistance drift of a Bulk Metal Foil resistor is less than 60 ppm (0.006%) after 10 years running at 0.1 W at 70°C.

FIGURE 6 - LOAD LIFE TEST FOR 10000 HRS @ 0.3W +125°C; Z201, N=24

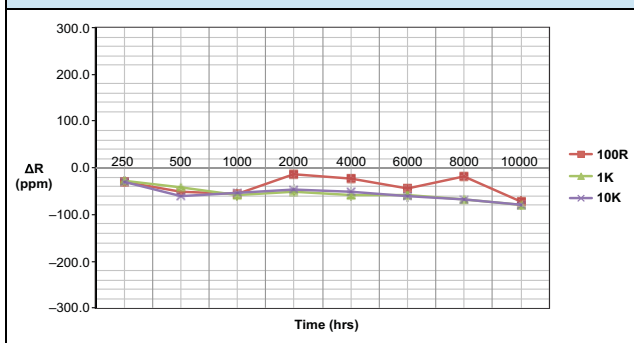

THERMAL EMF

In a resistor, the resistance is composed of a resistance element of one material and two terminations of a different material. When the junction of the element and the termination is heated in a closed circuit, there is a DC voltage generated in the circuit (see Seebeck and Peltier Effects). Hence, if both termination junctions of the resistor are at exactly the same temperature across terminations there is no net thermal EMF voltage generated in the circuit due to thermal EMF error voltages in the resistor.

In fact, however, the terminals are very seldom at the same temperature because their temperatures are influenced by uneven power dissipation within the resistor, differential heating from other components on the board, and heat conducted along the board itself. Obviously, in a sense resistor that's supposed to accurately convert a current to a voltage, the presence of an extraneous thermal EMF voltage could constitute a significant error source in the system. That is why it's important that Bulk Metal Foil resistors have a thermal EMF voltage of less than 0.1 mV/°C difference across the element to termination junction.

HARMONIC DISTORTION

Harmonic distortion is an important consideration in the choice of precision resistors for sensitive applications. A significant signal voltage across the resistor may change the resistance value depending on the construction, material, and size. Under these conditions Bulk Metal Foil resistors behave more linearly than other resistor types.

POWER COEFFICIENT OF RESISTANCE (PCR)

The TCR of a resistor for a given temperature range is established by measuring the resistance at two different ambient temperatures: at room temperature and in a cooling chamber or oven. The ratio of relative resistance change and temperature difference gives the chord slope of $\Delta R/R = f(T)$ curve. This slope is usually expressed in parts per million per degree Centigrade (ppm/°C). In these conditions, a uniform temperature is achieved in the measured resistance. In practice, however, the temperature rise of the resistor is also partially due to self-heating as a result of the power it is dissipating (self-heating). As stipulated by the Joule effect, when current flows through a resistance, there will be an associated generation of heat. Therefore, the TCR alone does not provide the actual resistance change for precision resistor. Hence, another metric is introduced to incorporate this inherent characteristic – the Power Coefficient of Resistance (PCR). PCR is expressed in parts per million per Watt or in ppm at rated power. In the case of Z-based Bulk Metal® Foil, the PCR is 5 ppm typical at rated power or 4 ppm per Watt typical for power resistors.

POST MANUFACTURING OPERATIONS (PMO)

Many analog applications can include requirements for performance under conditions of stress beyond the normal and over extended periods of time. This calls for more than just selecting a standard device and applying it to a circuit. The standard device may turn out to be all that is needed but an analysis of the projected service conditions should be made and it may well dictate a routine of stabilization known as post manufacturing operations or PMO. The PMO operations that will be discussed are only applicable to Bulk Metal® Foil resistors. They stabilize Bulk Metal Foil resistors while they are harmful to other types. Short time overload, accelerated load life, and temperature cycling are the three PMO exercises that do the most to reduce drifts down the road. VFR Bulk Metal Foil resistors are inherently stable as manufactured. These PMO exercises are only of value on Bulk Metal Foil resistors and they improve the performance by small but significant amounts. Users are encouraged to contact Vishay Foil Resistors' applications engineering for assistance in choosing the PMO operations that are right for their application.

TABLE 4 - "Z" SERIES SPECIFICATIONS	
Stability ⁽¹⁾ Load life at 2000 h Load life at 10 000 h	± 0.015 % (150 ppm) Maximum ΔR at 0.3 W/+ 125 °C ± 0.005 % (50 ppm) Maximum ΔR at 0.1 W/+ 70 °C ± 0.05 % (500 ppm) Maximum ΔR at 0.3 W/+ 125 °C ± 0.01 % (100 ppm) Maximum ΔR at 0.1 W/+ 70 °C
Current Noise	0.010 $\mu V_{RMS}/V$ of applied voltage (< - 40 dB)
High Frequency Operation Rise time Inductance (L) ⁽²⁾ Capacitance (C)	1.0 ns at 1 k Ω 0.1 μH maximum; 0.08 μH typical 1.0 pF maximum; 0.5 pF typical
Voltage Coefficient	< 0.1 ppm/V ⁽³⁾
Thermal EMF ⁽⁴⁾	0.05 $\mu V/^{\circ}C$ typical 1 $\mu V/W$ (Model Z201)

Notes

- (1) Load life ΔR maximum can be reduced by 80 %, please contact applications engineering department.
 (2) Inductance (L) due mainly to the leads.
 (3) The resolution limit of existing test equipment (within the measurement capability of the equipment, or "essentially zero".)
 (4) $\mu V/^{\circ}C$ relates to EMF due to lead temperature difference and $\mu V/watt$ due to power applied to the resistor.

FLOWER OF SULFUR

ASTM B 809, also known as flower of sulfur, is a test to determine the porosity of metallic coating using humid sulfur vapor. This vapor can penetrate conformal coatings and cause damage to the device when it reacts with lower layers of silver. Bulk Metal Foil resistors avoid this problem with a special coating that is proven to be reliable in extreme environments and even against sulfur. The flower of sulfur test is especially relevant to designers of circuits used in alternative energy and industrial applications, where environmental pollution is a constant concern. Analog circuitry in these applications almost always operates under severe environmental, thermal, and mechanical conditions, and must withstand frequent and extended service by professionals and novices alike. The picture is further complicated by tough regulatory restrictions and high consumer expectations. VFR received a steady stream of customer inquiries, which led to more focus on anti-sulfurated resistor research and development. As a result we have qualified our surface-mount foil chip resistors as "antisulfurated resistors." These are designed mainly for use in environments with high levels of contamination. Beyond alternative energy, applications include industrial control systems, sensors, RTDs, electric instrumentation, weather and communication base stations. These resistors are also suited for electronic appliances used in high concentrations of sulfur.

SHUNT CALIBRATION

Shunt calibration of a Wheatstone bridge strain gage circuit is a common and convenient method of periodically monitoring the gain or span of a signal conditioner being used in conjunction with a strain gage based transducer. A

fixed precision resistor such as the leaded Z-Series is placed, or "shunted," across one leg of the Wheatstone bridge. This doesn't amount to a complete calibration, since no mechanical pressure is actually applied. Instead, the shunt calibration provides a simulation of the mechanical input to a transducer by unbalancing the bridge and providing a scenario that shows how to reduce the errors and shifts associated with the electrical characteristics of the strain gages and the connected electrical components. The shunt resistor that is added in parallel to the strain gages simulates what would happen if a real load were measured by the pressure transducer or any other load cell configuration.

FIGURE 7 - BETTER STABILITY WITH THROUGH-HOLE

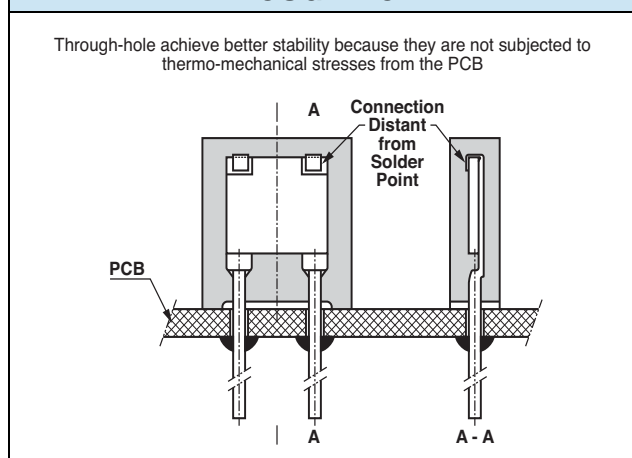
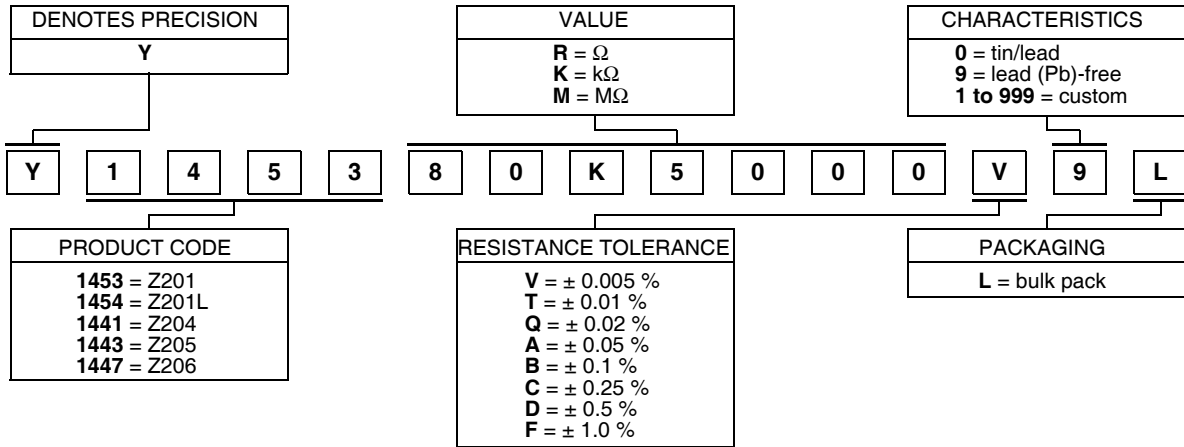

TABLE 5 - GLOBAL PART NUMBER INFORMATION (1)

NEW GLOBAL PART NUMBER: Y145380K5000V9L (preferred part number format)



FOR EXAMPLE: ABOVE GLOBAL ORDER Y1453 80K5000 V 9 L:

TYPE: Z201
VALUE: 80.5 $k\Omega$
ABSOLUTE TOLERANCE: $\pm 0.005\%$
TERMINATION: lead (Pb)-free
PACKAGING: bulk pack

HISTORICAL PART NUMBER: Z201 T 80K500 V B (will continue to be used)

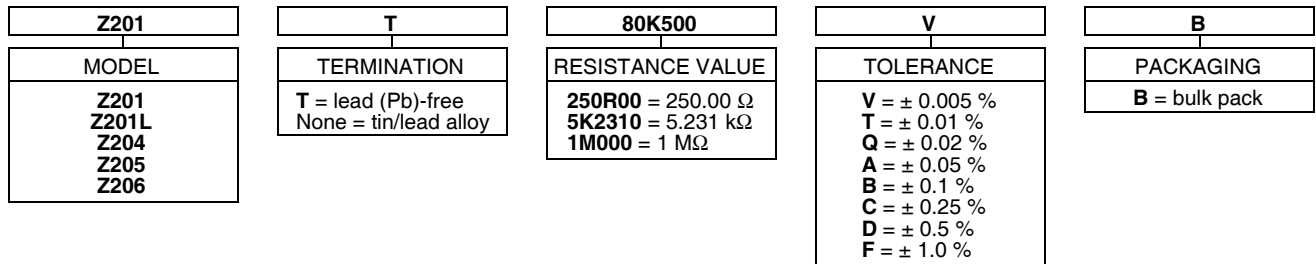

Note

(1) For non-standard requests, please contact application engineering.



Disclaimer

ALL PRODUCTS, PRODUCT SPECIFICATIONS AND DATA ARE SUBJECT TO CHANGE WITHOUT NOTICE.

Vishay Precision Group, Inc., its affiliates, agents, and employees, and all persons acting on its or their behalf (collectively, "VPG"), disclaim any and all liability for any errors, inaccuracies or incompleteness contained herein or in any other disclosure relating to any product.

The product specifications do not expand or otherwise modify VPG's terms and conditions of purchase, including but not limited to, the warranty expressed therein.

VPG makes no warranty, representation or guarantee other than as set forth in the terms and conditions of purchase. **To the maximum extent permitted by applicable law, VPG disclaims (i) any and all liability arising out of the application or use of any product, (ii) any and all liability, including without limitation special, consequential or incidental damages, and (iii) any and all implied warranties, including warranties of fitness for particular purpose, non-infringement and merchantability.**

Information provided in datasheets and/or specifications may vary from actual results in different applications and performance may vary over time. Statements regarding the suitability of products for certain types of applications are based on VPG's knowledge of typical requirements that are often placed on VPG products. It is the customer's responsibility to validate that a particular product with the properties described in the product specification is suitable for use in a particular application. You should ensure you have the current version of the relevant information by contacting VPG prior to performing installation or use of the product, such as on our website at vpgsensors.com.

No license, express, implied, or otherwise, to any intellectual property rights is granted by this document, or by any conduct of VPG.

The products shown herein are not designed for use in life-saving or life-sustaining applications unless otherwise expressly indicated. Customers using or selling VPG products not expressly indicated for use in such applications do so entirely at their own risk and agree to fully indemnify VPG for any damages arising or resulting from such use or sale. Please contact authorized VPG personnel to obtain written terms and conditions regarding products designed for such applications.

Product names and markings noted herein may be trademarks of their respective owners.

Copyright Vishay Precision Group, Inc., 2014. All rights reserved.