

Data sheet | Item number: 2002-1205

2-conductor through terminal block; 2.5 mm²; suitable for Ex e II applications; side and center marking; for DIN-rail 35 x 15 and 35 x 7.5; Push-in CAGE CLAMP®

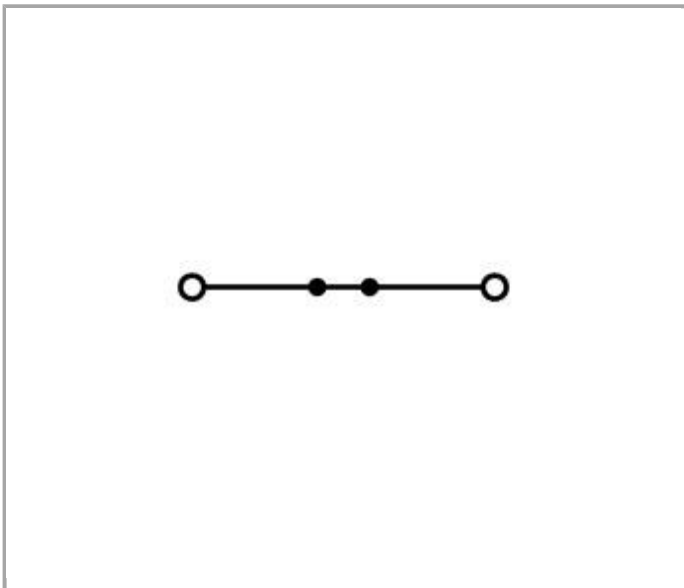

www.wago.com/2002-1205

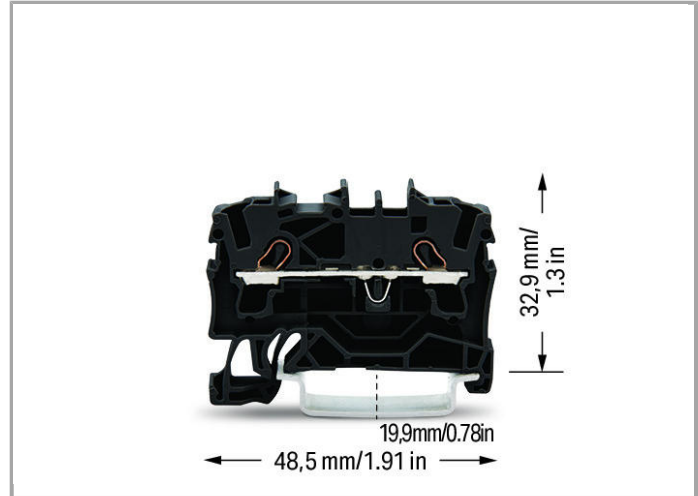
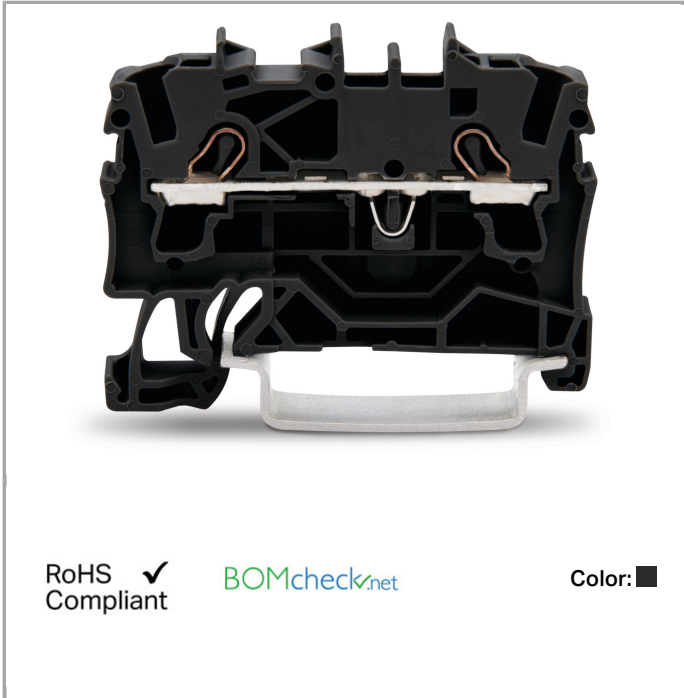

Data

Electrical data

Rated voltage EN (Ex e II)	550 V
Rated current (Ex e II)	22 A
Rated current (Ex e II) with jumper	20 A

Ratings per IEC/EN 60664-1

Rated voltage (III / 3)	800 V
Rated impulse voltage (III / 3)	8 kV
Rated current	24 A
Rated current (2)	32 A
Legend (ratings)	(III / 3) $\hat{=}$ Overvoltage category III / Pollution degree 3

Approvals per UL 1059

Rated voltage UL (Use Group B)	600 V
Rated current UL (Use Group B)	20 A
Rated voltage UL (Use Group C)	600 V
Rated current UL (Use Group C)	20 A

Approvals per CSA

Rated voltage CSA (Use Group B)	600 V
Rated current CSA (Use Group B)	20 A
Rated voltage CSA (Use Group C)	600 V
Rated current CSA (Use Group C)	20 A

Connection data

Connection technology	Push-in CAGE CLAMP®
Actuation type	Push-in Operating tool
Connectable conductor materials	Copper
Nominal cross section	2.5 mm ²
Solid conductor	0.25 ... 4 mm ² / 22 ... 12 AWG
Solid conductor, push-in termination	0.75 ... 4 mm ² / 18 ... 12 AWG
Fine-stranded conductor	0.25 ... 4 mm ² / 22 ... 12 AWG
Fine-stranded conductor with ferrule, push-in termination, from	0.75 mm ² / 18 AWG
Strip length	10 ... 12 mm / 0.39 ... 0.47 Inch
Total number of connection points	2
Total number of potentials	1
Number of levels	1
Type of wiring	Front-entry wiring

Geometrical Data

Width	5.2 mm / 0.205 inch
Height from upper-edge of DIN-35 rail	32.9 mm / 1.295 inch

Depth	48.5 mm / 1.909 inch
-------	----------------------

Mechanical data

Design	horizontal
Type of mounting	DIN-35 rail
Marking level	Center/side marking

Material Data





Color	black
Insulating material	Polyamide 66 (PA 66)
Fire load	0.109 MJ
Weight	4.9 g

Commercial data

Country of origin	DE
GTIN	4044918081399
Customs Tariff No.	85369010000
Product Group	22 (TOPJOB S)

Approvals / Certificates

Ex-Approvals

Logo	Approval	Certificate name
	AEx UL International Germany GmbH c/o Physikalisch Technische Bundesanstalt	E185892 sec.7
	AEx UL International Germany GmbH c/o Physikalisch Technische Bundesanstalt	E185892 sec.7
	ATEX Physikalisch Technische Bundesanstalt (PTB)	PTB 03 ATEX 1162 U (II 2 G/D Ex e II bzw. I M 2 Ex e I)
	IECEX Physikalisch Technische Bundesanstalt	IECEX PTB 03.0004U

Country specific Approvals

Logo	Approval	Certificate name
	CCA DEKRA Certification B.V.	NTR NL 7585

CCA



CSA
DEKRA Certification B.V.

1536069



CSA
DEKRA Certification B.V.

1536069



KEMA/KEUR
DEKRA Certification B.V.

2198985.01

Ship Approvals

Logo

Approval

Certificate name

ABS

ABS
American Bureau of Shipping

14-HG1293677-PDA

BV

BV
Bureau Veritas S.A.

38586/A0 BV



DNV GL
Det Norske Veritas, Germanischer Lloyd

TAE00001V2



LR
Lloyds Register

91/20112 (E9)

UL-Approvals

Logo

Approval

Certificate name

cURus

cURus
Underwriters Laboratories Inc.

E45172

Compatible products

Protective Warning Marker

**Item no.: 2002-115**

Protective warning marker; with high-voltage symbol, black; for 5 terminal blocks

www.wago.com/2002-115**General accessories****Item no.: 2002-880/1000-411**

Diode module; with diode 1N4007 As a free-wheeling diode; 10.4 mm wide; Operating temperature 85°C max.

www.wago.com/2002-880/1000-411**Item no.: 2002-880/1000-541**

LED module; with red LED; 10.4 mm wide; 12 - 30 V; Operating temperature 85°C max.

www.wago.com/2002-880/1000-541**Item no.: 2002-880/1000-542**

LED module

www.wago.com/2002-880/1000-542**Item no.: 2002-880/1000-836**















LED module; with red LED; 10.4 mm wide; 230 V; Operating temperature 85°C max.

www.wago.com/2002-880/1000-836**ferrule****Item no.: 216-241**Ferrule; Sleeve for 0.5 mm² / AWG 22; insulated; electro-tin plated; electrolytic copper; gastight crimped; acc. to DIN 46228, Part 4/09.90www.wago.com/216-241**Item no.: 216-242**Ferrule; Sleeve for 0.75 mm² / AWG 20; insulated; electro-tin plated; electrolytic copper; gastight crimped; acc. to DIN 46228, Part 4/09.90www.wago.com/216-242**Item no.: 216-243**Ferrule; Sleeve for 1 mm² / AWG 18; insulated; electro-tin plated; electrolytic copper; gastight crimped; acc. to DIN 46228, Part 4/09.90www.wago.com/216-243**Item no.: 216-244**Ferrule; Sleeve for 1.5 mm² / AWG 16; insulated; electro-tin plated; electrolytic copper; gastight crimped; acc. to DIN 46228, Part 4/09.90www.wago.com/216-244**Item no.: 216-246**Ferrule; Sleeve for 2.5 mm² / AWG 14; insulated; electro-tin plated; electrolytic copper; gastight crimped; acc. to DIN 46228, Part 4/09.90www.wago.com/216-246**Item no.: 216-262**Ferrule; Sleeve for 0.75 mm² / AWG 20; insulated; electro-tin plated; electrolytic copper; gastight crimped; acc. to DIN 46228, Part 4/09.90www.wago.com/216-262**Item no.: 216-263**Ferrule; Sleeve for 1 mm² / AWG 18; insulated; electro-tin plated; electrolytic copper; gastight crimped; acc. to DIN 46228, Part 4/09.90www.wago.com/216-263**Item no.: 216-264**Ferrule; Sleeve for 1.5 mm² / AWG 16; insulated; electro-tin plated; electrolytic copper; gastight crimped; acc. to DIN 46228, Part 4/09.90www.wago.com/216-264**Item no.: 216-266**Ferrule; Sleeve for 2.5 mm² / AWG 14; insulated; electro-tin plated; electrolytic copper; gastight crimped; acc. to DIN 46228, Part 4/09.90www.wago.com/216-266**plug****Item no.: 2002-880**



Empty component plug housing; 10.4 mm wide; 2-pole; Type 4



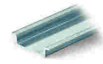

www.wago.com/2002-880

check

	Item no.: 2002-511 Modular TOPJOB®S connector; modular; for jumper contact slot; 1-pole	www.wago.com/2002-511
	Item no.: 2002-549 Spacer module; modular; e.g., for bridging commoned terminal blocks	www.wago.com/2002-549
	Item no.: 2002-552 TOPJOB®S connector strip; for jumper contact slot; 2-pole	www.wago.com/2002-552
	Item no.: 2002-553 TOPJOB®S connector strip; for jumper contact slot; 3-pole	www.wago.com/2002-553
	Item no.: 2002-554 TOPJOB®S connector strip; for jumper contact slot; 4-pole	www.wago.com/2002-554
	Item no.: 2002-555 TOPJOB®S connector strip; for jumper contact slot; 5-pole	www.wago.com/2002-555
	Item no.: 2002-556 TOPJOB®S connector strip; for jumper contact slot; 6-pole	www.wago.com/2002-556
	Item no.: 2002-557 TOPJOB®S connector strip; for jumper contact slot; 7-pole	www.wago.com/2002-557
	Item no.: 2002-558 TOPJOB®S connector strip; for jumper contact slot; 8-pole	www.wago.com/2002-558
	Item no.: 2002-559 TOPJOB®S connector strip; for jumper contact slot; 9-pole	www.wago.com/2002-559
	Item no.: 2002-560 TOPJOB®S connector strip; for jumper contact slot; 10-pole	www.wago.com/2002-560
	Item no.: 2002-611 TOPJOB®S L-type test plug module; modular; 1-pole	www.wago.com/2002-611
	Item no.: 2002-649 TOPJOB®S L-type spacer module; modular; e.g., for bridging commoned terminal blocks	www.wago.com/2002-649
	Item no.: 2009-174 Test plug adapter; for 4 mm Ø test plugs; for testing TOPJOB®S rail-mounted terminal blocks	www.wago.com/2009-174
	Item no.: 2009-182 Testing tap; for max. 2.5 mm ² ; tool-free connection for individual test wires 0.08 - 2.5 mm	www.wago.com/2009-182

Carrier rail

	Item no.: 210-112 Steel carrier rail; 35 x 7.5 mm; 1 mm thick; 2 m long; slotted; according to EN 60715; "Hole width 25 mm	www.wago.com/210-112
	Item no.: 210-113 Steel carrier rail; 35 x 7.5 mm; 1 mm thick; 2 m long; unslotted; according to EN 60715	www.wago.com/210-113
	Item no.: 210-114 Steel carrier rail; 35 x 15 mm; 1.5 mm thick; 2 m long; unslotted; similar to EN 60715	www.wago.com/210-114

















	Item no.: 210-115 Steel carrier rail; 35 x 7.5 mm; 1 mm thick; 2 m long; slotted; according to EN 60715; "Hole width 18 mm	www.wago.com/210-115
	Item no.: 210-118 Steel carrier rail; 35 x 15 mm; 2.3 mm thick; 2 m long; unslotted; according to EN 60715	www.wago.com/210-118
	Item no.: 210-196 Aluminum carrier rail; 35 x 8.2 mm; 1.6 mm thick; 2 m long; unslotted; similar to EN 60715	www.wago.com/210-196
	Item no.: 210-197 Steel carrier rail; 35 x 15 mm; 1.5 mm thick; 2 m long; slotted; similar to EN 60715	www.wago.com/210-197
	Item no.: 210-198 Copper carrier rail; 35 x 15 mm; 2.3 mm thick; 2 m long; unslotted; according to EN 60715	www.wago.com/210-198

Insulation stop

	Item no.: 2002-171 Insulation stop; 0.25 - 0.5 mm ² ; 5 pieces/strip	www.wago.com/2002-171
	Item no.: 2002-172 Insulation stop; 0.75 - 1 mm ² ; 5 pieces/strip	www.wago.com/2002-172

Marking accessories

	Item no.: 2002-161 Adaptor	www.wago.com/2002-161
	Item no.: 2009-110 Marking strips; on reel; not stretchable; plain; snap-on type	www.wago.com/2009-110
	Item no.: 2009-115 WMB-Inline; for smartPRINTER; on reel; stretchable 5 - 5.2 mm; plain; snap-on type	www.wago.com/2009-115
	Item no.: 2009-115/000-002 WMB-Inline; for smartPRINTER; on reel; stretchable 5 - 5.2 mm; plain; snap-on type	www.wago.com/2009-115/000-002
	Item no.: 2009-115/000-006 WMB-Inline; for smartPRINTER; on reel; stretchable 5 - 5.2 mm; plain; snap-on type	www.wago.com/2009-115/000-006
	Item no.: 2009-115/000-007 WMB-Inline; for smartPRINTER; on reel; stretchable 5 - 5.2 mm; plain; snap-on type	www.wago.com/2009-115/000-007
	Item no.: 2009-115/000-012 WMB-Inline; for smartPRINTER; on reel; stretchable 5 - 5.2 mm; plain; snap-on type	www.wago.com/2009-115/000-012
	Item no.: 2009-115/000-017 WMB-Inline; for smartPRINTER; on reel; stretchable 5 - 5.2 mm; plain; snap-on type	www.wago.com/2009-115/000-017
	Item no.: 2009-115/000-023 WMB-Inline; for smartPRINTER; on reel; stretchable 5 - 5.2 mm; plain; snap-on type	www.wago.com/2009-115/000-023

	<p>Item no.: 2009-115/000-024 WMB-Inline; for smartPRINTER; on reel; stretchable 5 - 5.2 mm; plain; snap-on type</p>	www.wago.com/2009-115/000-024
	<p>Item no.: 2009-145 Mini-WSB Inline; for smartPRINTER; on reel; stretchable 5 - 5.2 mm; plain; snap-on type</p>	www.wago.com/2009-145
	<p>Item no.: 2009-145/000-002 Mini-WSB Inline; for smartPRINTER; on reel; stretchable 5 - 5.2 mm; plain; snap-on type</p>	www.wago.com/2009-145/000-002
	<p>Item no.: 2009-145/000-005 Mini-WSB Inline; for smartPRINTER; on reel; stretchable 5 - 5.2 mm; plain; snap-on type</p>	www.wago.com/2009-145/000-005
	<p>Item no.: 2009-145/000-006 Mini-WSB Inline; for smartPRINTER; on reel; stretchable 5 - 5.2 mm; plain; snap-on type</p>	www.wago.com/2009-145/000-006
	<p>Item no.: 2009-145/000-007 Mini-WSB Inline; for smartPRINTER; on reel; stretchable 5 - 5.2 mm; plain; snap-on type</p>	www.wago.com/2009-145/000-007
	<p>Item no.: 2009-145/000-012 Mini-WSB Inline; for smartPRINTER; on reel; stretchable 5 - 5.2 mm; plain; snap-on type</p>	www.wago.com/2009-145/000-012
	<p>Item no.: 2009-145/000-023 Mini-WSB Inline; for smartPRINTER; on reel; stretchable 5 - 5.2 mm; plain; snap-on type</p>	www.wago.com/2009-145/000-023
	<p>Item no.: 2009-145/000-024 Mini-WSB Inline; on reel; stretchable 5 - 5.2 mm; plain; snap-on type</p>	www.wago.com/2009-145/000-024
	<p>Item no.: 2009-191 Group marker carrier</p>	www.wago.com/2009-191
	<p>Item no.: 2009-192 Group marker carrier</p>	www.wago.com/2009-192
	<p>Item no.: 2009-193 Group marker carrier</p>	www.wago.com/2009-193
	<p>Item no.: 2009-198 Adaptor</p>	www.wago.com/2009-198
	<p>Item no.: 248-501 Miniature WSB Quick marking system; plain; Marker width 5 mm; 10 strips with 10 markers per card</p>	www.wago.com/248-501
	<p>Item no.: 248-501/000-002 Mini-WSB marking card; as card; not stretchable; plain; snap-on type</p>	www.wago.com/248-501/000-002
	<p>Item no.: 248-501/000-005 Mini-WSB marking card; as card; plain; snap-on type</p>	www.wago.com/248-501/000-005



Item no.: 248-501/000-006
Mini-WSB marking card; as card; not stretchable; plain; snap-on type

www.wago.com/248-501/000-006



Item no.: 248-501/000-007
Mini-WSB marking card; as card; not stretchable; plain; snap-on type

www.wago.com/248-501/000-007



Item no.: 248-501/000-012
Mini-WSB marking card; as card; not stretchable; plain; snap-on type

www.wago.com/248-501/000-012



Item no.: 248-501/000-017
Mini-WSB marking card; as card; not stretchable; plain; snap-on type

www.wago.com/248-501/000-017



Item no.: 248-501/000-023
Mini-WSB marking card; as card; not stretchable; plain; snap-on type

www.wago.com/248-501/000-023



Item no.: 248-501/000-024
Mini-WSB marking card; as card; not stretchable; plain; snap-on type

www.wago.com/248-501/000-024



Item no.: 793-501
WMB marking card; as card; not stretchable; plain; snap-on type

www.wago.com/793-501



Item no.: 793-501/000-002
WMB marking card; as card; not stretchable; plain; snap-on type

www.wago.com/793-501/000-002



Item no.: 793-501/000-005
WMB marking card; as card; not stretchable; plain; snap-on type

www.wago.com/793-501/000-005



Item no.: 793-501/000-006
WMB marking card; as card; not stretchable; plain; snap-on type

www.wago.com/793-501/000-006



Item no.: 793-501/000-007
WMB marking card; as card; not stretchable; plain; snap-on type

www.wago.com/793-501/000-007



Item no.: 793-501/000-012
WMB marking card; as card; not stretchable; plain; snap-on type

www.wago.com/793-501/000-012



Item no.: 793-501/000-017
WMB marking card; as card; not stretchable; plain; snap-on type

www.wago.com/793-501/000-017

















Item no.: 793-501/000-023
WMB marking card; as card; not stretchable; plain; snap-on type

















www.wago.com/793-501/000-023



Item no.: 793-501/000-024
WMB marking card; as card; not stretchable; plain; snap-on type

www.wago.com/793-501/000-024

	Item no.: 793-5501 WMB marking card; as card; for terminal block width 5 - 17.5 mm; stretchable 5 - 5.2 mm; plain; snap-on type	www.wago.com/793-5501
	Item no.: 793-5501/000-002 WMB marking card; as card; for terminal block width 5 - 17.5 mm; stretchable 5 - 5.2 mm; plain; snap-on type	www.wago.com/793-5501/000-002
	Item no.: 793-5501/000-005 WMB marking card; as card; stretchable 5 - 5.2 mm; plain; snap-on type	www.wago.com/793-5501/000-005
	Item no.: 793-5501/000-006 WMB marking card; as card; stretchable 5 - 5.2 mm; plain; snap-on type	www.wago.com/793-5501/000-006
	Item no.: 793-5501/000-007 WMB marking card; as card; stretchable 5 - 5.2 mm; plain; snap-on type	www.wago.com/793-5501/000-007
	Item no.: 793-5501/000-012 WMB marking card; as card; stretchable 5 - 5.2 mm; plain; snap-on type	www.wago.com/793-5501/000-012
	Item no.: 793-5501/000-017 WMB marking card; as card; stretchable 5 - 5.2 mm; plain; snap-on type	www.wago.com/793-5501/000-017
	Item no.: 793-5501/000-023 WMB marking card; as card; stretchable 5 - 5.2 mm; plain; snap-on type	www.wago.com/793-5501/000-023
	Item no.: 793-5501/000-024 WMB marking card; as card; stretchable 5 - 5.2 mm; plain; snap-on type	www.wago.com/793-5501/000-024
End plate		
	Item no.: 2002-1291 End and intermediate plate; 0.8 mm thick	www.wago.com/2002-1291
	Item no.: 2002-1292 End and intermediate plate; 0.8 mm thick	www.wago.com/2002-1292
	Item no.: 2002-1293 Separator plate; 2 mm thick; oversized	www.wago.com/2002-1293
	Item no.: 2002-1294 Separator plate; 2 mm thick; oversized	www.wago.com/2002-1294
	Item no.: 209-190 Separator for Ex e/Ex i applications; 3 mm thick; 90 mm wide	www.wago.com/209-190
	Item no.: 209-191 Separator for Ex e/Ex i applications; 3 mm thick; 120 mm wide	www.wago.com/209-191
Jumper		

	Item no.: 2002-400 Adjacent jumper for continuous commoning; insulated; 2-way; Nominal current 25 A	www.wago.com/2002-400
	Item no.: 2002-402 Push-in type jumper bar; insulated; 2-way; Nominal current 25 A	www.wago.com/2002-402
	Item no.: 2002-402/000-005 Push-in type jumper bar; insulated; 2-way; Nominal current 25 A	www.wago.com/2002-402/000-005
	Item no.: 2002-402/000-006 Push-in type jumper bar; insulated; 2-way; Nominal current 25 A	www.wago.com/2002-402/000-006
	Item no.: 2002-403 Push-in type jumper bar; insulated; 3-way; Nominal current 25 A	www.wago.com/2002-403
	Item no.: 2002-403/000-005 Push-in type jumper bar; insulated; 3-way; Nominal current 25 A	www.wago.com/2002-403/000-005
	Item no.: 2002-403/000-006 Push-in type jumper bar; insulated; 3-way; Nominal current 25 A	www.wago.com/2002-403/000-006
	Item no.: 2002-404 Push-in type jumper bar; insulated; 4-way; Nominal current 25 A	www.wago.com/2002-404
	Item no.: 2002-404/000-005 Push-in type jumper bar; insulated; 4-way; Nominal current 25 A	www.wago.com/2002-404/000-005
	Item no.: 2002-404/000-006 Push-in type jumper bar; insulated; 4-way; Nominal current 25 A	www.wago.com/2002-404/000-006
	Item no.: 2002-405 Push-in type jumper bar; insulated; 5-way; Nominal current 25 A	www.wago.com/2002-405
	Item no.: 2002-405/000-005 Push-in type jumper bar; insulated; 5-way; Nominal current 25 A	www.wago.com/2002-405/000-005
	Item no.: 2002-405/000-006 Push-in type jumper bar; insulated; 5-way; Nominal current 25 A	www.wago.com/2002-405/000-006
	Item no.: 2002-405/011-000 Star point jumper; insulated; 3-way (1-3-5); IN = IN terminal block	www.wago.com/2002-405/011-000
	Item no.: 2002-406 Push-in type jumper bar; insulated; 6-way; Nominal current 25 A	www.wago.com/2002-406
	Item no.: 2002-406/000-005 Push-in type jumper bar; insulated; 6-way; Nominal current 25 A	www.wago.com/2002-406/000-005



Item no.: 2002-406/000-006
Push-in type jumper bar; insulated; 6-way; Nominal current 25 A

www.wago.com/2002-406/000-006



Item no.: 2002-406/020-000
Delta jumper; insulated; 1-2 3-4 5-6; IN = IN terminal block

www.wago.com/2002-406/020-000



Item no.: 2002-407
Push-in type jumper bar; insulated; 7-way; Nominal current 25 A

www.wago.com/2002-407



Item no.: 2002-407/000-005
Push-in type jumper bar; insulated; 7-way; Nominal current 25 A

www.wago.com/2002-407/000-005



Item no.: 2002-407/000-006
Push-in type jumper bar; insulated; 7-way; Nominal current 25 A

www.wago.com/2002-407/000-006



Item no.: 2002-408
Push-in type jumper bar; insulated; 8-way; Nominal current 25 A

www.wago.com/2002-408



Item no.: 2002-408/000-005
Push-in type jumper bar; insulated; 8-way; Nominal current 25 A

www.wago.com/2002-408/000-005



Item no.: 2002-408/000-006
Push-in type jumper bar; insulated; 8-way; Nominal current 25 A

www.wago.com/2002-408/000-006



Item no.: 2002-409
Push-in type jumper bar; insulated; 9-way; Nominal current 25 A

www.wago.com/2002-409



Item no.: 2002-409/000-005
Push-in type jumper bar; insulated; 9-way; Nominal current 25 A

www.wago.com/2002-409/000-005



Item no.: 2002-409/000-006
Push-in type jumper bar; insulated; 9-way; Nominal current 25 A

www.wago.com/2002-409/000-006



Item no.: 2002-410
Push-in type jumper bar; insulated; 10-way; Nominal current 25 A

www.wago.com/2002-410



Item no.: 2002-410/000-005
Push-in type jumper bar; insulated; 10-way; Nominal current 25 A

www.wago.com/2002-410/000-005



Item no.: 2002-410/000-006
Push-in type jumper bar; insulated; 10-way; Nominal current 25 A

www.wago.com/2002-410/000-006

















Item no.: 2002-423
Push-in type jumper bar; insulated; from 1 to 3; Nominal current 25 A















www.wago.com/2002-423



Item no.: 2002-423/000-005
Adjacent jumper for continuous commoning; insulated; from 1 to 3; Nominal current 25 A

www.wago.com/2002-423/000-005

	Item no.: 2002-423/000-006 Adjacent jumper for continuous commoning; insulated; from 1 to 3; Nominal current 25 A	www.wago.com/2002-423/000-006
	Item no.: 2002-433 Push-in type jumper bar; insulated; from 1 to 3; Nominal current 25 A	www.wago.com/2002-433
	Item no.: 2002-434 Push-in type jumper bar; insulated; from 1 to 4; Nominal current 25 A	www.wago.com/2002-434
	Item no.: 2002-435 Push-in type jumper bar; insulated; from 1 to 5; Nominal current 25 A	www.wago.com/2002-435
	Item no.: 2002-436 Push-in type jumper bar; insulated; from 1 to 6; Nominal current 25 A	www.wago.com/2002-436
	Item no.: 2002-437 Push-in type jumper bar; insulated; from 1 to 7; Nominal current 25 A	www.wago.com/2002-437
	Item no.: 2002-438 Push-in type jumper bar; insulated; from 1 to 8; Nominal current 25 A	www.wago.com/2002-438
	Item no.: 2002-439 Push-in type jumper bar; insulated; from 1 to 9; Nominal current 25 A	www.wago.com/2002-439
	Item no.: 2002-440 Push-in type jumper bar; insulated; from 1 to 10; Nominal current 25 A	www.wago.com/2002-440
	Item no.: 2002-472 Staggered jumper; insulated; 2-way; Nominal current 25 A; suitable for 2002 and 2003 Series rail-mounted terminal blocks	www.wago.com/2002-472
	Item no.: 2002-473 Staggered jumper; insulated; 3-way; Nominal current 25 A; suitable for 2002 and 2003 Series rail-mounted terminal blocks	www.wago.com/2002-473
	Item no.: 2002-473/011-000 Ready-made staggered jumper; insulated; 2-way (1-3); Nominal current 25 A; with contact lugs broken off at the factory and circuit marking	www.wago.com/2002-473/011-000
	Item no.: 2002-474 Staggered jumper; insulated; 4-way; Nominal current 25 A; suitable for 2002 and 2003 Series rail-mounted terminal blocks	www.wago.com/2002-474
	Item no.: 2002-475 Staggered jumper; insulated; 5-way; Nominal current 25 A; suitable for 2002 and 2003 Series rail-mounted terminal blocks	www.wago.com/2002-475
	Item no.: 2002-475/011-000 Ready-made staggered jumper; insulated; 3-way (1-3-5); Nominal current 25 A; with contact lugs broken off at the factory and circuit marking	www.wago.com/2002-475/011-000
	Item no.: 2002-476 Staggered jumper; insulated; 6-way; Nominal current 25 A; suitable for 2002 and 2003 Series rail-mounted terminal blocks	www.wago.com/2002-476
	Item no.: 2002-477 Staggered jumper; insulated; 7-way; Nominal current 25 A; suitable for 2002 and 2003 Series rail-mounted terminal blocks	www.wago.com/2002-477
	Item no.: 2002-477/011-000 Ready-made staggered jumper; insulated; 1-3-5-7; Nominal current 25 A; with contact lugs broken off at the factory and circuit marking	www.wago.com/2002-477/011-000

	Item no.: 2002-478 Staggered jumper; insulated; 8-way; Nominal current 25 A; suitable for 2002 and 2003 Series rail-mounted terminal blocks	www.wago.com/2002-478
	Item no.: 2002-479 Staggered jumper; insulated; 9-way; Nominal current 25 A; suitable for 2002 and 2003 Series rail-mounted terminal blocks	www.wago.com/2002-479
	Item no.: 2002-479/011-000 Ready-made staggered jumper; insulated; 1-3-5-7-9; Nominal current 25 A; with contact lugs broken off at the factory and circuit marking	www.wago.com/2002-479/011-000
	Item no.: 2002-480 Staggered jumper; insulated; 10-way; Nominal current 25 A; suitable for 2002 and 2003 Series rail-mounted terminal blocks	www.wago.com/2002-480
	Item no.: 2002-481 Staggered jumper; insulated; 11-way; Nominal current 25 A; suitable for 2002 and 2003 Series rail-mounted terminal blocks	www.wago.com/2002-481
	Item no.: 2002-481/011-000 Ready-made staggered jumper; insulated; 1-3-5-7-9-11; Nominal current 25 A; with contact lugs broken off at the factory and circuit marking	www.wago.com/2002-481/011-000
	Item no.: 2002-482 Staggered jumper; insulated; 12-way; Nominal current 25 A; suitable for 2002 and 2003 Series rail-mounted terminal blocks	www.wago.com/2002-482
	Item no.: 2006-499 Step-down jumper; insulated; from 6/4 mm ² to 4/2.5/1.5 mm ² ; Nominal current 32 A	www.wago.com/2006-499
	Item no.: 2009-412 Push-in type wire jumper; insulated; wire length 60 mm; Conductor cross section 1.5 mm ² ; suitable for 2001, 2002, 2003 and 2022 Series rail-mounted terminal blocks	www.wago.com/2009-412
	Item no.: 2009-414 Push-in type wire jumper; insulated; wire length 110 mm; Conductor cross section 1.5 mm ² ; suitable for 2001, 2002, 2003 and 2022 Series rail-mounted terminal blocks	www.wago.com/2009-414
	Item no.: 2009-416 Push-in type wire jumper; insulated; wire length 250 mm; Conductor cross section 1.5 mm ² ; suitable for 2001, 2002, 2003 and 2022 Series rail-mounted terminal blocks	www.wago.com/2009-416
	Item no.: 2016-499 Step-down jumper; insulated; from 16/10 mm ² to 10/6/4/2.5 mm ² ; Nominal current 57 A	www.wago.com/2016-499
	Item no.: 210-103 Wire commoning chain; insulated; 50 connections	www.wago.com/210-103
	Item no.: 210-123 Wire commoning chain; insulated; 50 connections	www.wago.com/210-123
tools		
	Item no.: 210-658 Operating tool with partially insulated shaft; Blade (3.5 x 0.5) mm; short; angled	www.wago.com/210-658
	Item no.: 210-720 Operating tool with partially insulated shaft; Type 2, blade (3.5 x 0.5) mm	www.wago.com/210-720



Downloads

Documentation

Bid Text

2002-1205	Aug 13, 2018	DOCX	Download
Reihenklemmen, TOPJOB S		15.0 kB	

smartDATA

CAD data

3D Download 2002-1205		URL	Download
-----------------------	--	-----	----------

Subject to changes.