



TAOGLAS®



Datasheet

Synergy 9 in 1 Antenna

Part No:
MA1509.AK.001

Description:

- 1*Active GNSS with RG-174LL & SMA(M)
- 5*5G/4G MIMO with RG-174LL & SMA(M)
- 3*Wi-Fi MIMO with RG-174LL & RP-SMA(M)

Features:

- 4 x 5G/4G(600MHz-6GHz) MIMO Antenna
- 1 x 5G/4G(1.7-6GHz) Antenna
- 3 x Wi-Fi 2.4GHz/5GHz MIMO Antenna
- 1 x GPS/GLONASS/BeiDou Antenna Front End GNSS SAW Filter
- IP67 Rated Waterproof Enclosure
- High Efficiency/Peak Gain Outdoor Antenna
- Cable: 300mm RG-174LL with 4700mm TGC-200
- Connectors: SMA(M) / RP-SMA(M)
- RoHS & REACH Compliant

1. Introduction	3
2. Specifications	4
3. Active Antenna Characteristics	10
4. Antenna Characteristics	16
5. Radiation Patterns	24
6. Mechanical Drawing	81
7. Packaging	82
Changelog	83

Taoglas makes no warranties based on the accuracy or completeness of the contents of this document and reserves the right to make changes to specifications and product descriptions at any time without notice. Taoglas reserves all rights to this document and the information contained herein. Reproduction, use or disclosure to third parties without express permission is strictly prohibited.



1. Introduction



The Taoglas Synergy MA1509.AK.001 is a 9-in-1 next-generation permanent mount antenna for vehicle roof applications. It has a fully IP67 rated waterproof robust PC enclosure and base. The 9 antennas inside support 5G/4G, GPS/GLONASS/BeiDou, Wi-Fi (2.4GHz/5GHz). This outstanding patent-pending antenna delivers powerful MIMO antenna technology for 5G/4G, Wi-Fi 2.4/5.8GHz 802.11n and the emerging 802.11ac, and an optimized GPS/GLONASS/BeiDou patch antenna for location. The 5G/4G antennas also include backward compatibility to work at most worldwide 2G and 3G bands.

Typical Applications:

- Next Generation OEM Automotive Connectivity
- Multimedia, Navigation and Telematics Systems
- V2V, V2X and Fleet Management Applications
- Real-time HD Video Streaming
- First Net Responder Routers

The MA1509 is ideal for applications that require highly sophisticated antennas for real-time streaming applications that demand high-speed video uplink and downlink into the cabin of the vehicle. These challenges are resolved by the highly efficient, high gain MIMO antennas, with high isolation, all of which is necessary to achieve the required signal to noise ratio and throughput.

The MA1509 can also be customized for your particular wireless application and frequency band, subject to NRE and MOQ. There are 8x 300mm RG-174 low loss cables, terminating in SMA(M) connectors for 5G/4G MIMO 5X5 and RP SMA(M) for Wi-Fi MIMO 3X3. There is a 300mm RG-174 cable for GNSS terminating in an SMA(M) connector.

All cable lengths and connector types are customizable. The Synergy MA1509 can be supplied with low loss TGC-200 cable extensions for longer cable runs. Contact your regional Taoglas customer services team for details and support.

2. Specifications

GNSS Frequency Bands Covered							
GPS/QZSS	L1 1575.42MHz	L2 1227.6MHz	L5 1176.45MHz	L6 1278.75MHz			
	■	□	□	□			
GLONASS	L5R 1176.45MHz	L3PT 1201.5MHz	L2PT 1246MHz	L1CR 1575.42MHz	L1PT 1602MHz		
	□	□	□	■	■		
Galileo	E5a 1176.45MHz	E5b 1201.5MHz	E4 1215MHz	E3 1256MHz	E6 1278.75MHz	E2 1561MHz	L1 1575.42MHz
	□	□	□	□	□	■	■
BeiDou	B1 1561MHz	B2 1207.14MHz	B3 1268.52MHz				
	■	□	□				
Compass	E5B(B2)/ E6(B3) 1268.56MHz	E2(B1) 1561MHz					
	□	■					
SBAS	Omnistar 1542.5MHz	WAAS/EGN OS 1575.42MHz					
	□	■					

GNSS Electrical			
Frequency (MHz)	1561	1575.42	1602
VSWR (max.)	2.5	2.5	2.5
Passive Antenna Efficiency (%) (Without cable loss)	40.02	48.39	44.29
Passive Antenna Gain at Zenith (dBic) (Without cable loss)	3.75	4.44	4.54
Axial Ratio (dB)	20	11	15
Polarization	RHCP		
Impedance	50Ω		
Cable	RG-174		
Connector	SMA(M)		

LNA and Filter Electrical Properties			
Frequency (MHz)	1561	1575.42	1602
VSWR (max.)	2.0:1	2.0:1	2.0:1
Gain@1.8V (dBic)	28.8 dB	28.8 dB	28 dB
Gain@3.0V (dBic)	29 dB	29 dB	28.3 dB
Gain@5.5V (dBic)	29.6 dB	29.4 dB	28.7 dB
Noise@1.8V (dB)	2.8 dB	2.3 dB	2.8 dB
Noise@3.0V (dB)	2.8 dB	2.2 dB	2.8 dB
Noise@5.5V (dB)	2.9 dB	2.3 dB	2.8 dB
Power consumption@1.8V (mA)	8.7 mA		
Power consumption@3.0V (mA)	9.0 mA		
Power consumption@5.5V (mA)	11 mA		
Total Specification (Through Antenna, SAW Filter and LNA)			
Frequency (MHz)	1561	1575.42	1602
Gain@3V (dBic)	31.7 ± 3	32.4 ± 3	32.4 ± 3
Output Impedance	50Ω		

5G/4G Antenna											
Frequency (MHz)		5G NR Band 71	LTE700	GSM 850/900	5G NR Band	DCS	PCS	UMTS1	LTE2600	5G NR Band 77, 78, 79	LTE5200/Wi-Fi 5800
		617 ~698	698 ~824	824 ~960	1427 ~1518	1710 ~1880	1850 ~1990	1920 ~2170	2300 ~2690	3300 ~3800	5150 ~5925
Efficiency (%)											
MIMO 1	5m	21.5	22.7	40.5	33.8	37.2	26.1	23.7	29.5	37.0	33.8
MIMO 2	5m	18.5	23.2	38.6	34.2	35.9	25.6	23.4	28.4	37.1	32.8
MIMO 3	5m	18.3	24.2	26.9	35.4	37.9	32.3	29.9	37.1	23.4	30.7
MIMO 4	5m	20.1	23.6	25.8	36.7	37.0	32.9	30.9	36.4	22.3	33.1
MIMO 5	5m	1.8	1.4	4.3	9.1	34.4	27.4	31.6	36.4	31.4	29.4
Average Gain (dB)											
MIMO 1	5m	-6.67	-6.45	-3.92	-4.71	-4.30	-5.83	-6.26	-5.30	-4.32	-4.71
MIMO 2	5m	-7.32	-6.35	-4.13	-4.66	-4.45	-5.92	-6.31	-5.46	-4.30	-4.84
MIMO 3	5m	-7.37	-6.16	-5.70	-4.51	-4.22	-4.91	-5.24	-4.31	-6.31	-5.13
MIMO 4	5m	-6.96	-6.26	-5.88	-4.36	-4.31	-4.83	-5.10	-4.39	-6.51	-4.81
MIMO 5	5m	-17.49	-18.55	-13.65	-10.39	-4.63	-5.63	-5.00	-4.39	-5.03	-5.32
Peak Gain (dBi)											
MIMO 1	5m	-1.92	-0.37	2.96	2.22	2.72	0.23	0.03	2.24	4.28	3.33
MIMO 2	5m	-2.48	-0.56	2.44	2.08	3.07	0.38	0.03	2.28	4.26	3.20
MIMO 3	5m	-2.19	-1.41	0.47	2.04	3.29	1.64	1.69	3.19	1.61	2.87
MIMO 4	5m	-2.14	-1.54	0.05	2.13	2.97	1.62	1.25	3.40	1.03	3.57
MIMO 5	5m	-11.80	-12.86	-8.10	-2.93	2.90	1.90	2.00	1.94	4.97	3.88
Impedance	50 Ω										
Polarization	Linear										
Radiation Pattern	Omni										
Max. input power	10W										

Wi-Fi MIMO				
Frequency (MHz)		2400~2500		5150~5850
Efficiency (%)				
MIMO 1	5m	33.16		42.72
MIMO 2	5m	47.59		47.92
MIMO 3	5m	35.95		35.76
Average Gain (dB)				
MIMO 1	5m	-4.79		-3.69
MIMO 2	5m	-3.22		-3.19
MIMO 3	5m	-4.44		-4.47
Peak Gain (dBi)				
MIMO 1	5m	Free Space	-0.63	-1.89
		30*30cm Ground Plane	2.16	0.73
MIMO 2	5m	Free Space	-0.50	-1.89
		30*30cm Ground Plane	1.24	1.65
MIMO 3	5m	Free Space	-0.63	-2.30
		30*30cm Ground Plane	1.65	-0.07
Impedance		50 Ω		
Polarization		Linear		
Radiation Pattern		Omni		
Max. input power		10W		

Mechanical	
Height	57.47mm
Planner Dimension	Ø160mm
Casing	PC
Cable	0.3m RG-174LL with 4.7m TGC-200 for 5G/4G – Fully Customizable 0.3m RG-174LL with 4.7m TGC-200 for Wi-Fi – Fully Customizable 0.3m RG174LL with 4.7m TGC-200 for GNSS – Fully Customizable
Connector	5G/4G_SMA-Plug – Fully Customizable Wi-Fi_RP-SMA-Plug – Fully Customizable GNSS_SMA-Plug – Fully Customizable
Thread	18.23mm
Thread Diameter	M22
Waterproof	IP67
Sealant	Rubber Stopper and O-Ring
Weight	2.7Kg
Environmental	
Ingress Protection	IP67
Temperature Range	-40°C to 85°C
Humidity	Non-condensing 65°C 95% RH
Cable Pull	RG-174 4 Kg

5G/4G Bands			
Band Number	5G NR / FR1 / LTE / LTE-Advanced / WCDMA / HSPA / HSPA+ / TD-SCDMA		
	Uplink	Downlink	Covered
1	UL: 1920 to 1980	DL: 2110 to 2170	✓
2	UL: 1850 to 1910	DL: 1930 to 1990	✓
3	UL: 1710 to 1785	DL: 1805 to 1880	✓
4	UL: 1710 to 1755	DL: 2110 to 2155	✓
5	UL: 824 to 849	DL: 869 to 894	✓
7	UL: 2500 to 2570	DL: 2620 to 2690	✓
8	UL: 880 to 915	DL: 925 to 960	✓
9	UL: 1749.9 to 1784.9	DL: 1844.9 to 1879.9	✓
11	UL: 1427.9 to 1447.9	DL: 1475.9 to 1495.9	✓
12	UL: 699 to 716	DL: 729 to 746	✓
13	UL: 777 to 787	DL: 746 to 756	✓
14	UL: 788 to 798	DL: 758 to 768	✓
17	UL: 704 to 716	DL: 734 to 746	✓
18	UL: 815 to 830	DL: 860 to 875	✓
19	UL: 830 to 845	DL: 875 to 890	✓
20	UL: 832 to 862	DL: 791 to 821	✓
21	UL: 1447.9 to 1462.9	DL: 1495.9 to 1510.9	✓
22	UL: 3410 to 3490	DL: 3510 to 3590	✓
23	UL: 2000 to 2020	DL: 2180 to 2200	✓
24	UL: 1625.5 to 1660.5	DL: 1525 to 1559	✓
25	UL: 1850 to 1915	DL: 1930 to 1995	✓
26	UL: 814 to 849	DL: 859 to 894	✓
27	UL: 807 to 824	DL: 852 to 869	✓
28	UL: 703 to 748	DL: 758 to 803	✓
29	UL: -	DL: 717 to 728	✓
30	UL: 2305 to 2315	DL: 2350 to 2360	✓
31	UL: 452.5 to 457.5	DL: 462.5 to 467.5	✗
32	UL: -	DL: 1452 - 1496	✓
35		1850 to 1910	✓
38		2570 to 2620	✓
39		1880 to 1920	✓
40		2300 to 2400	✓
41		2496 to 2690	✓
42		3400 to 3600	✓
43		3600 to 3800	✓
48		3550 to 3700	✓
66	UL: 1710-1780	DL: 2110-2200	✓
71		617 to 698	✓
74/75/76		1427 to 1518	✓
78		3300 to 3800	✓
79		4400 to 5000	✓

* Covered Bands represent greater than 20% efficiency

3. Active Antenna Characteristics

3.1 Block Diagram (Active antenna)

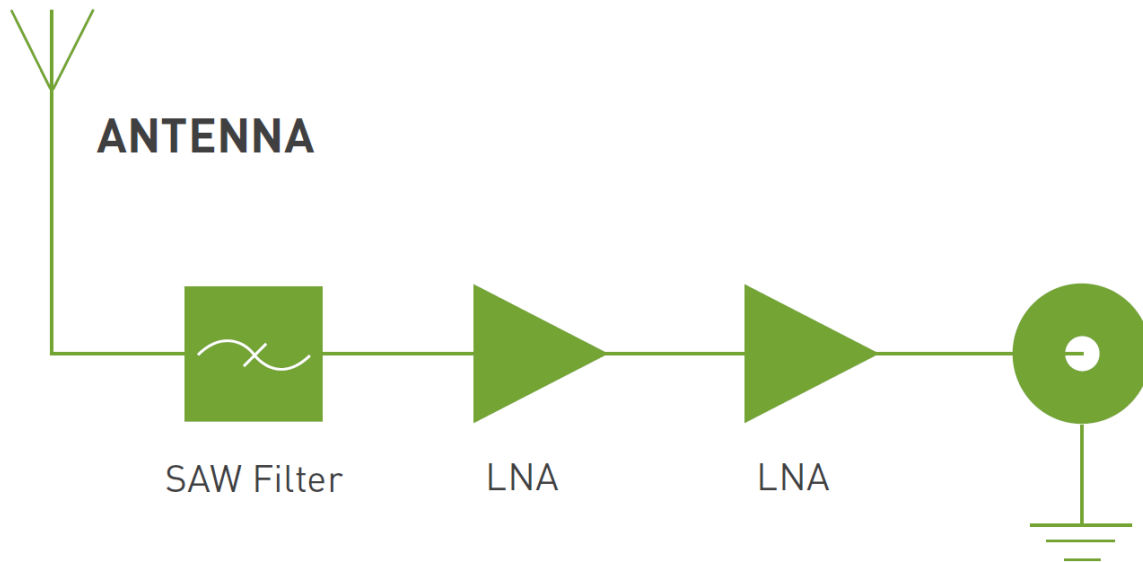

3.2 Passive Antenna Return Loss

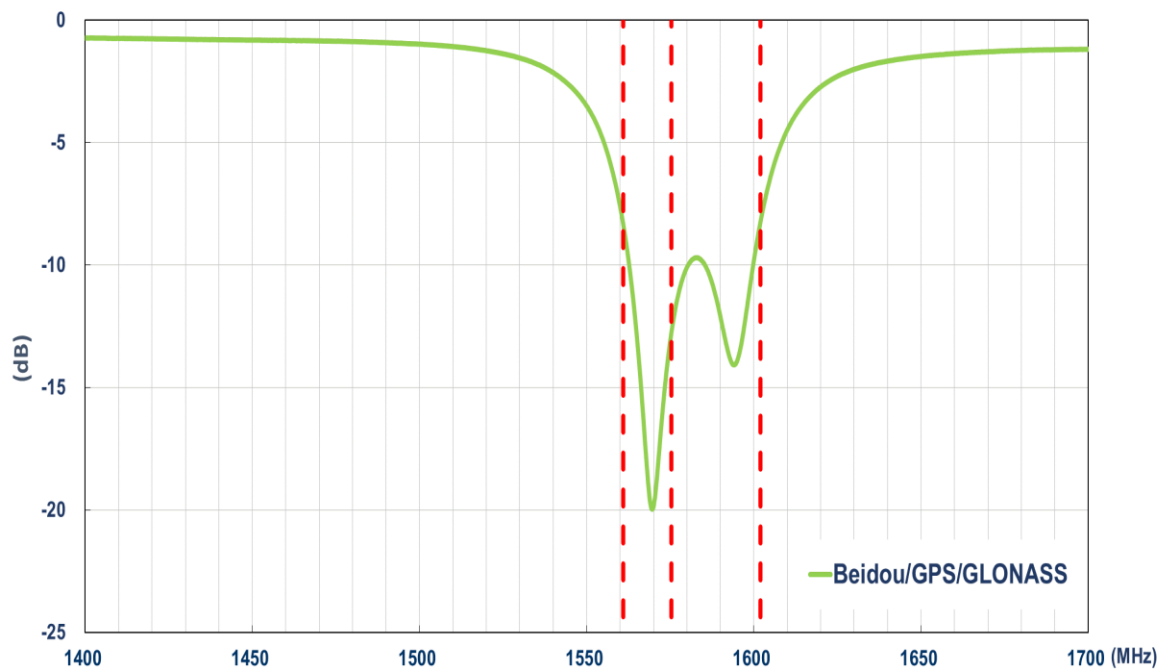

3.3 Passive Antenna Efficiency

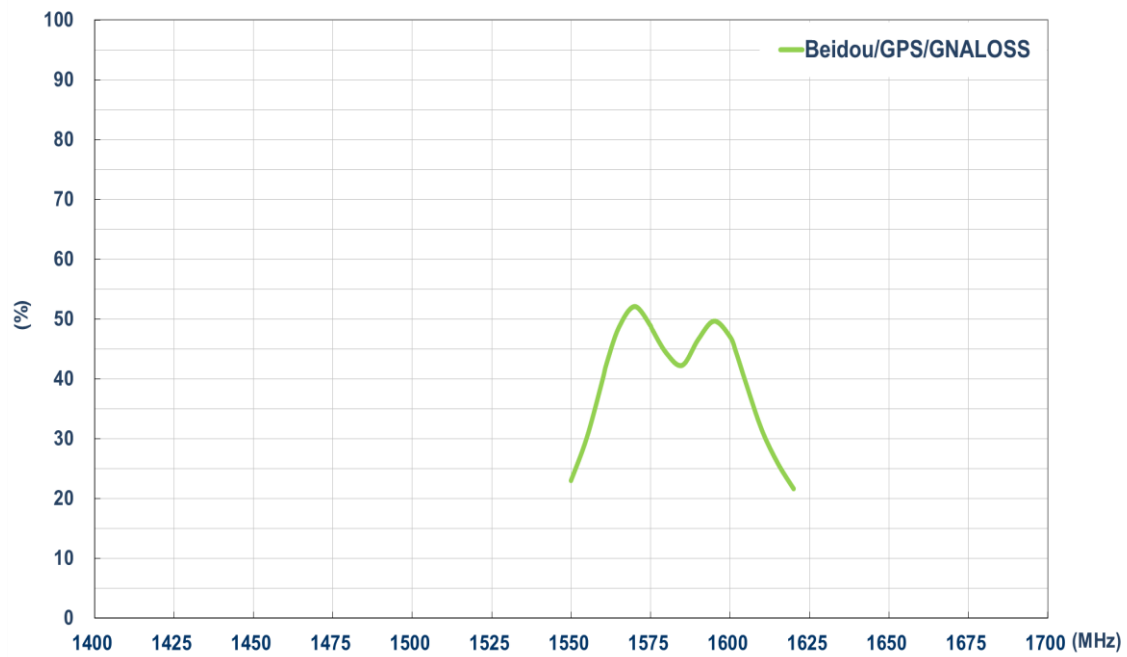

3.4 Passive Antenna Average Gain

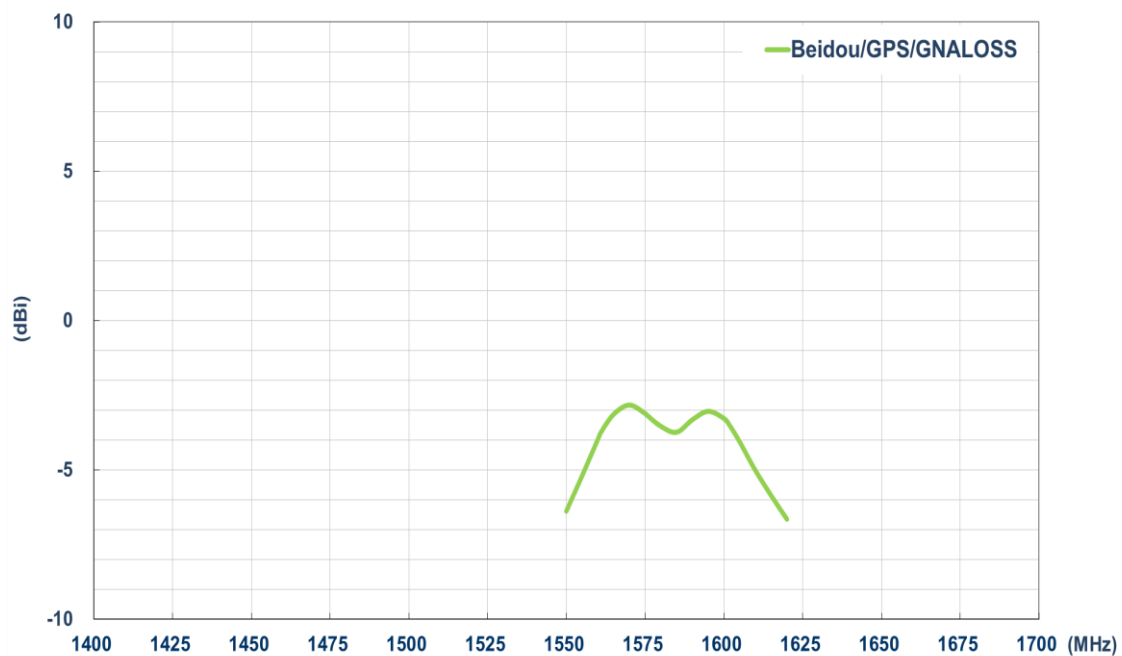

3.5 Passive Antenna Peak Gain

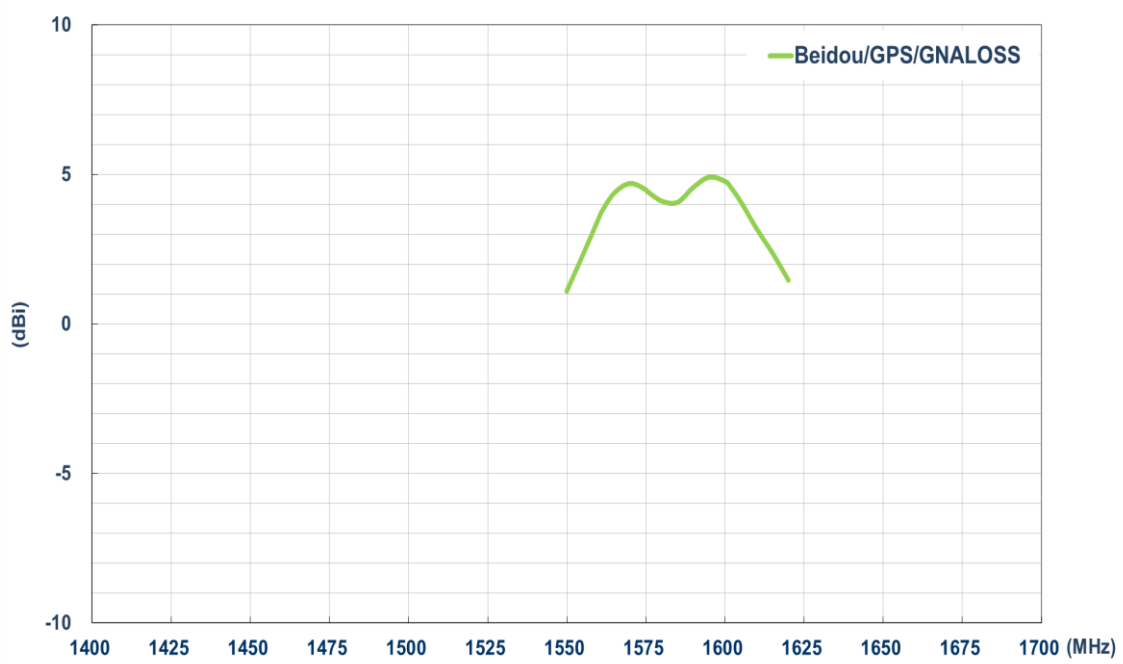

3.6 Passive Antenna Axial Ratio (Zenith is at 0°)

XZ-plane

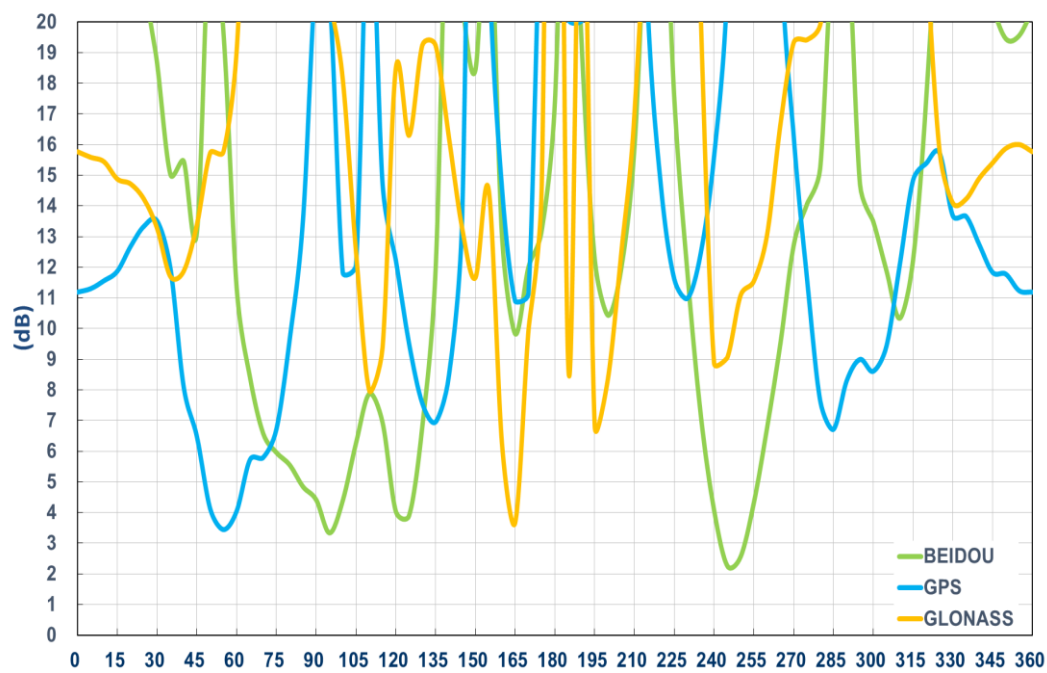

YZ-plane

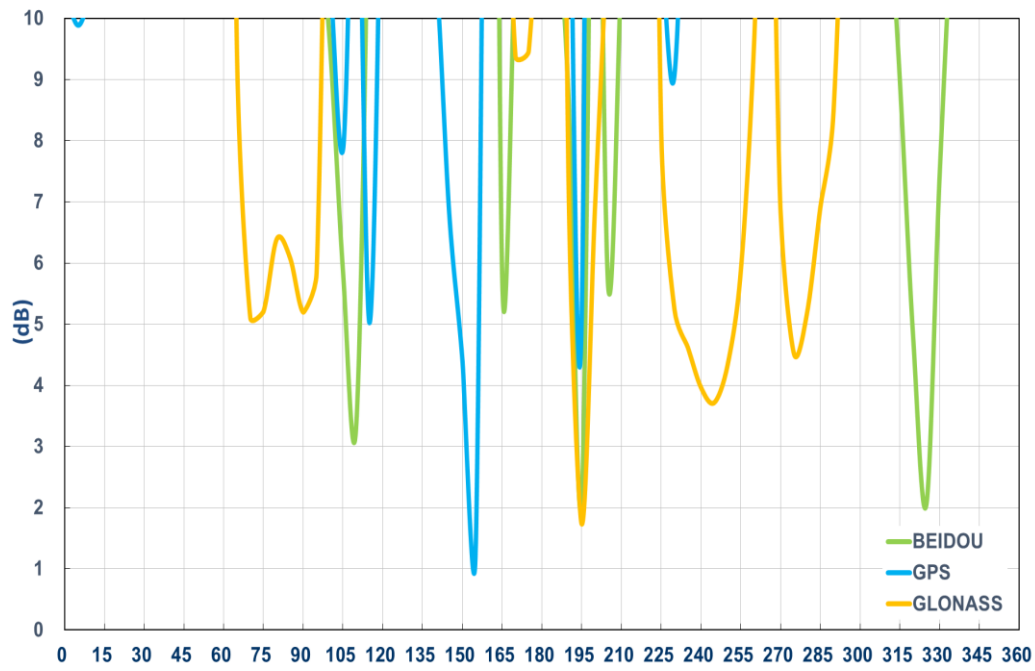

3.7 Active measurements

LNA Gain @ 3.0V

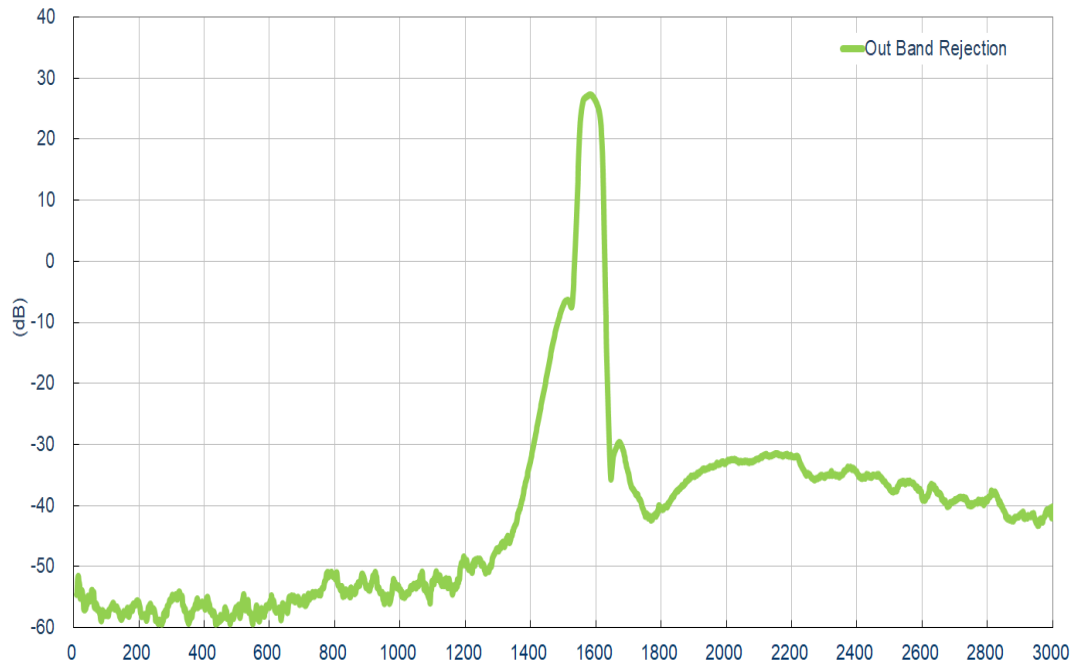

Noise Figure @ 3.0V

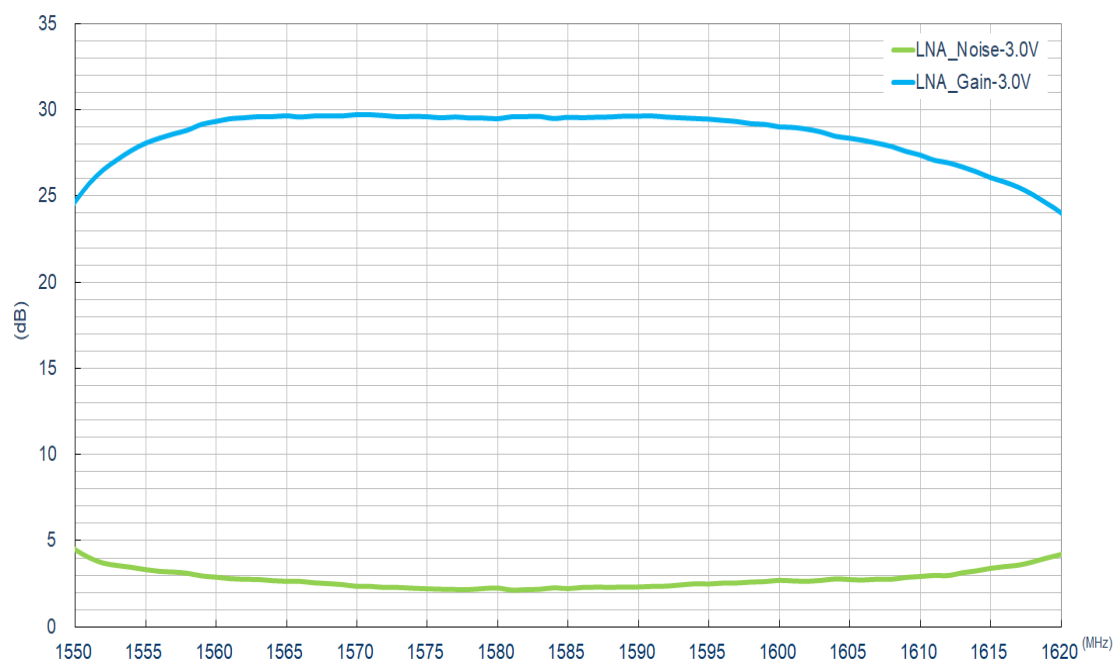

3.8 Passive Antenna Radiation Patterns

1575.42MHz

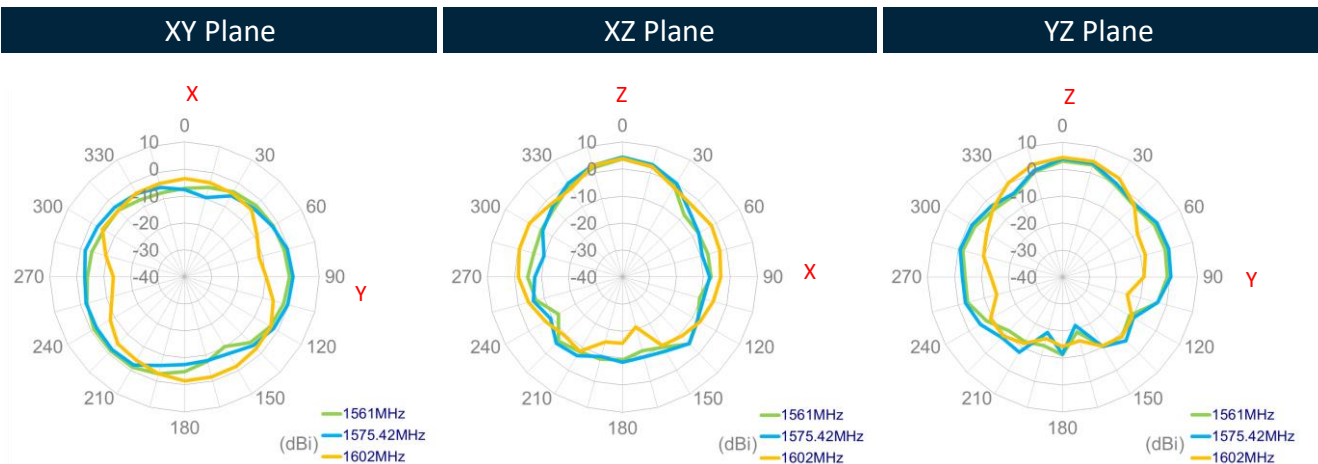
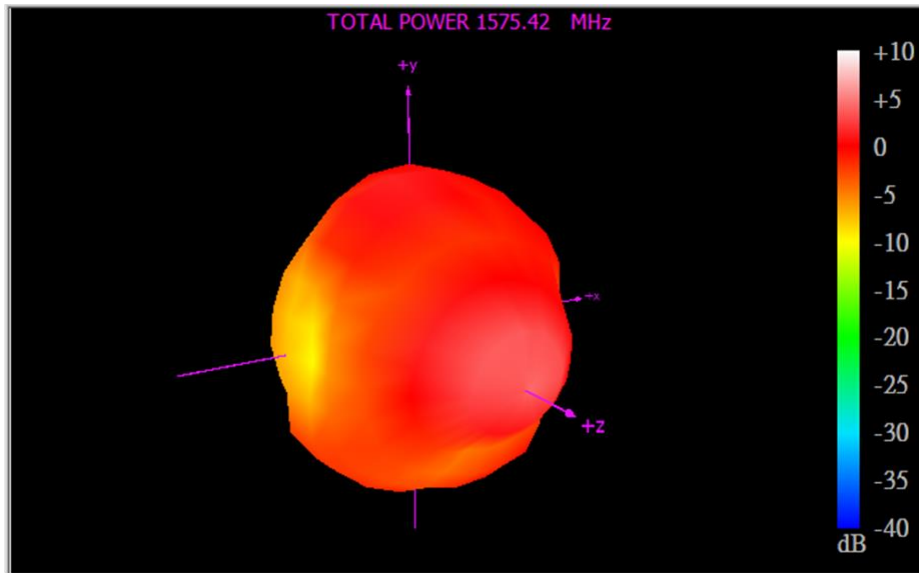

4. Antenna Characteristics

4.1 Return Loss

5G/4G MIMO

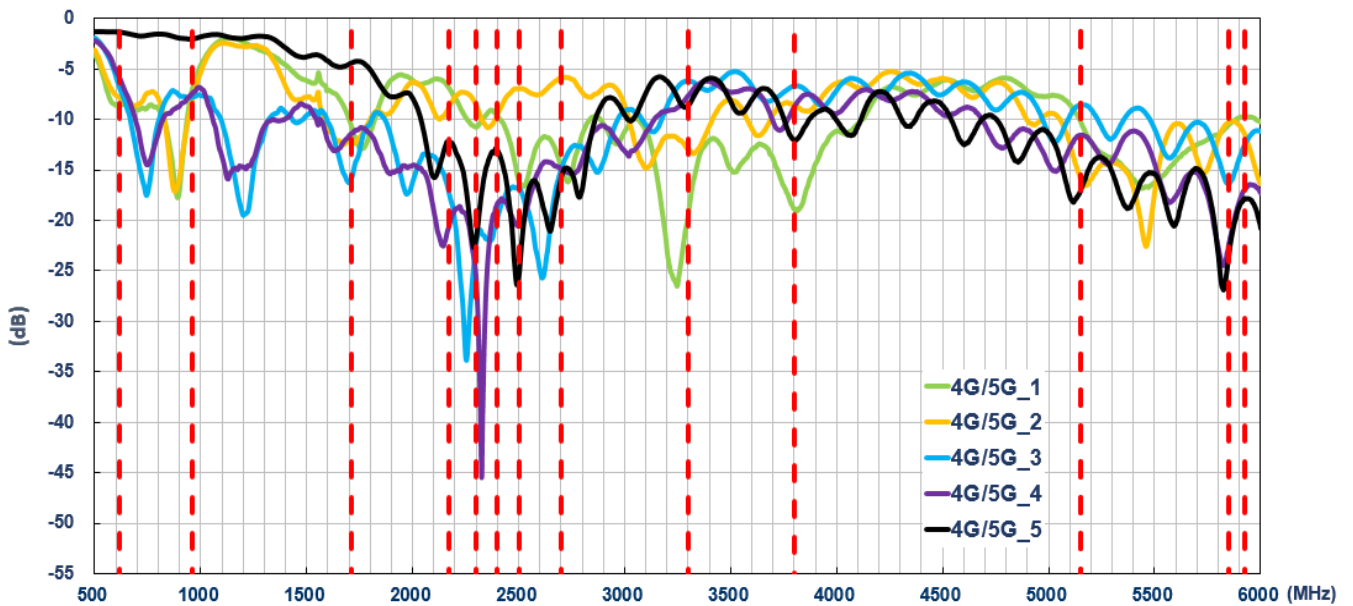

Wi-Fi MIMO

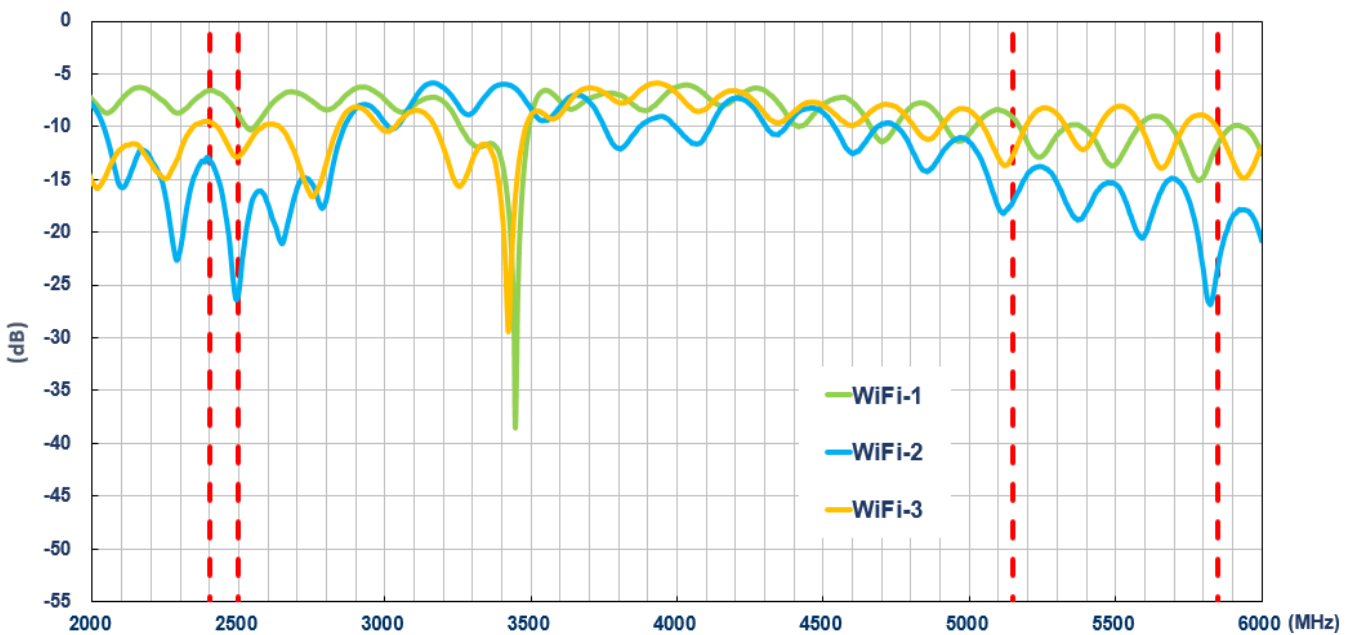

4.2 Isolation

5G/4G 1

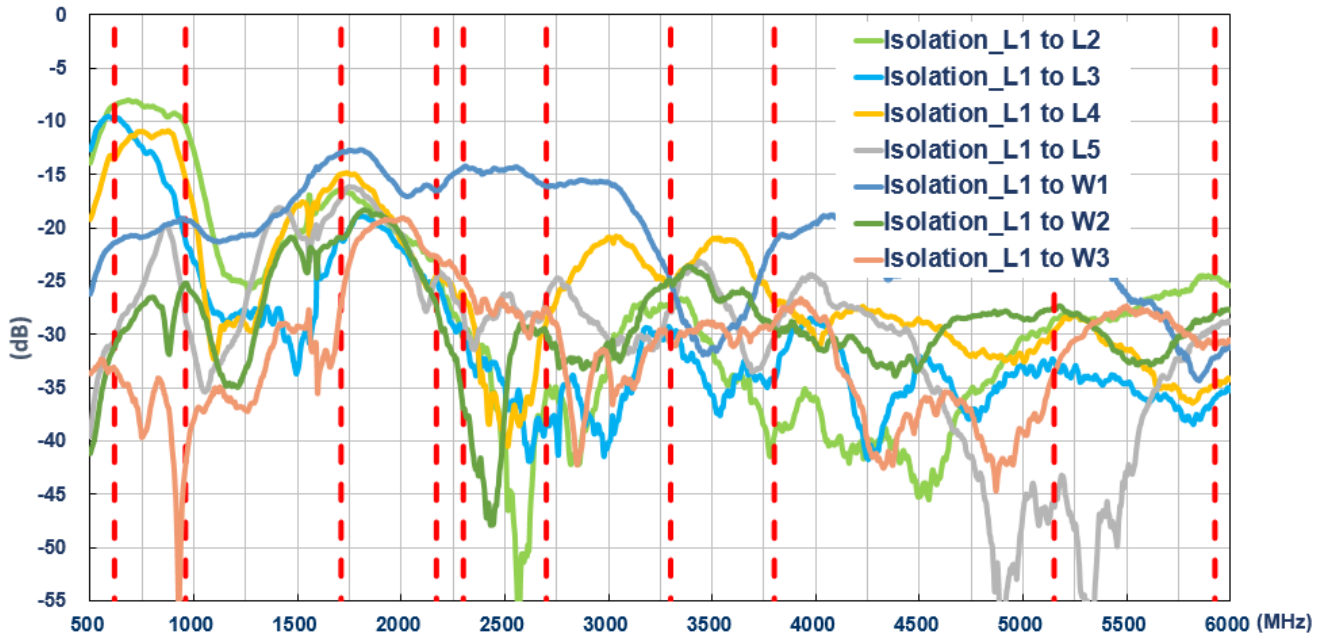

5G/4G 2

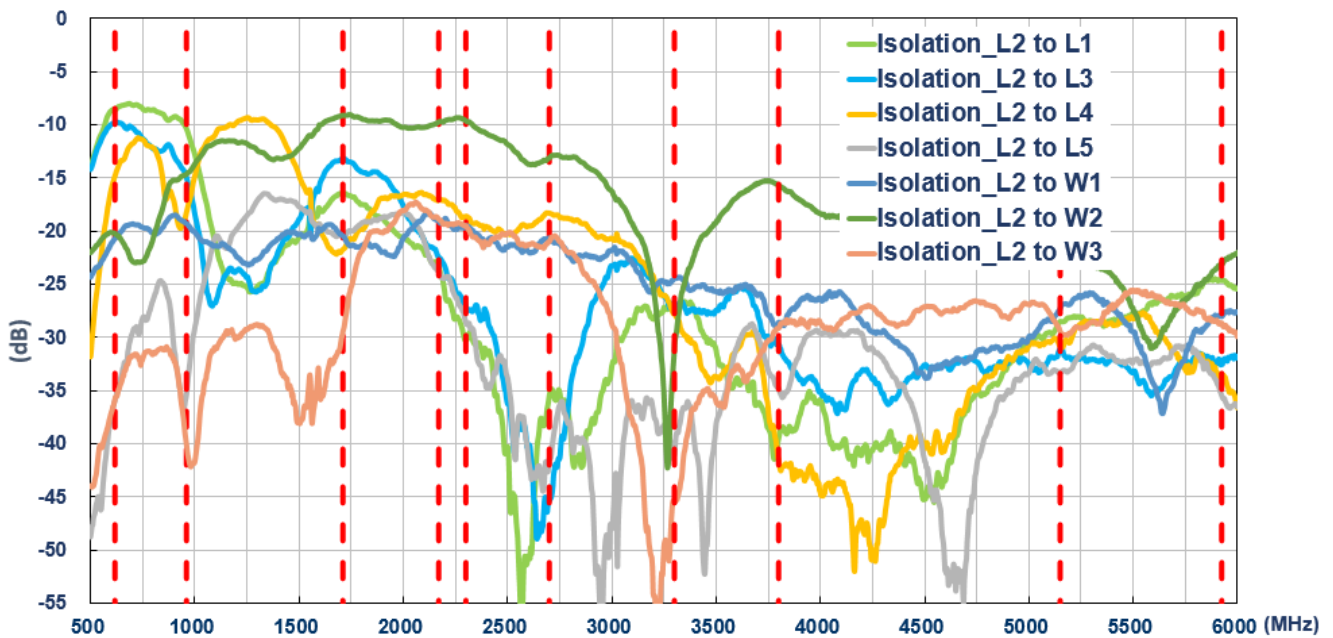

5G/4G 3

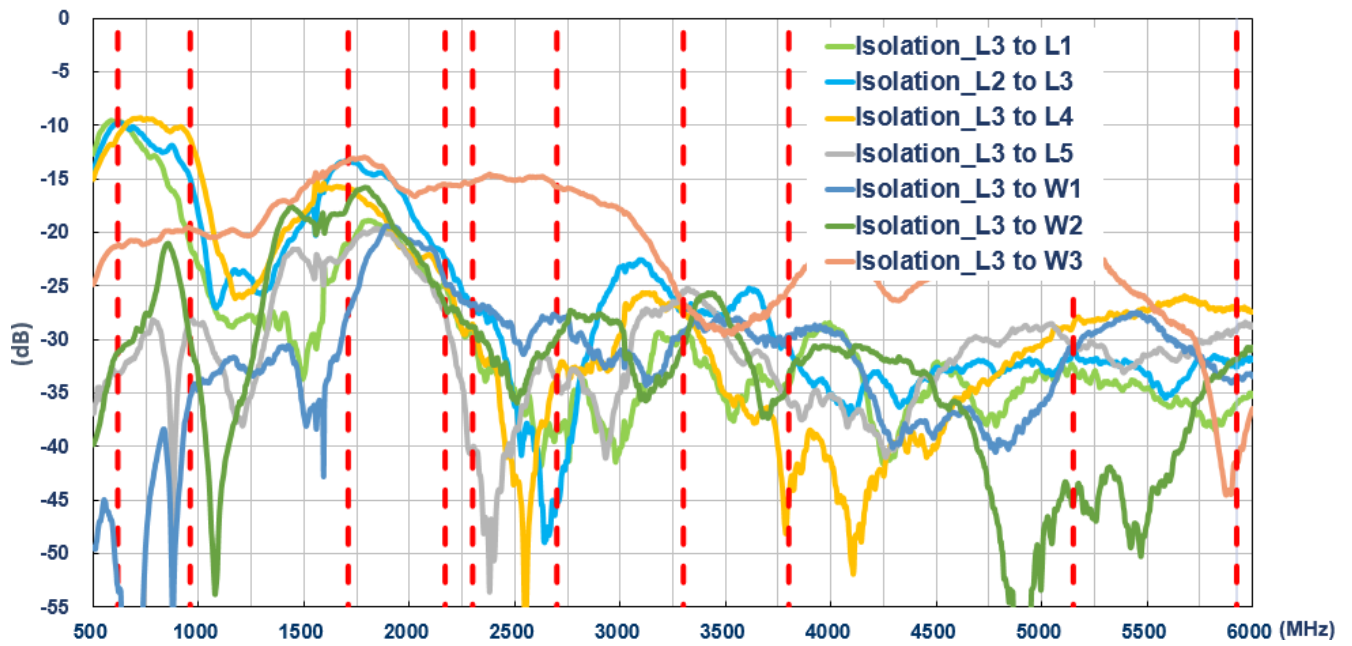

5G/4G 4

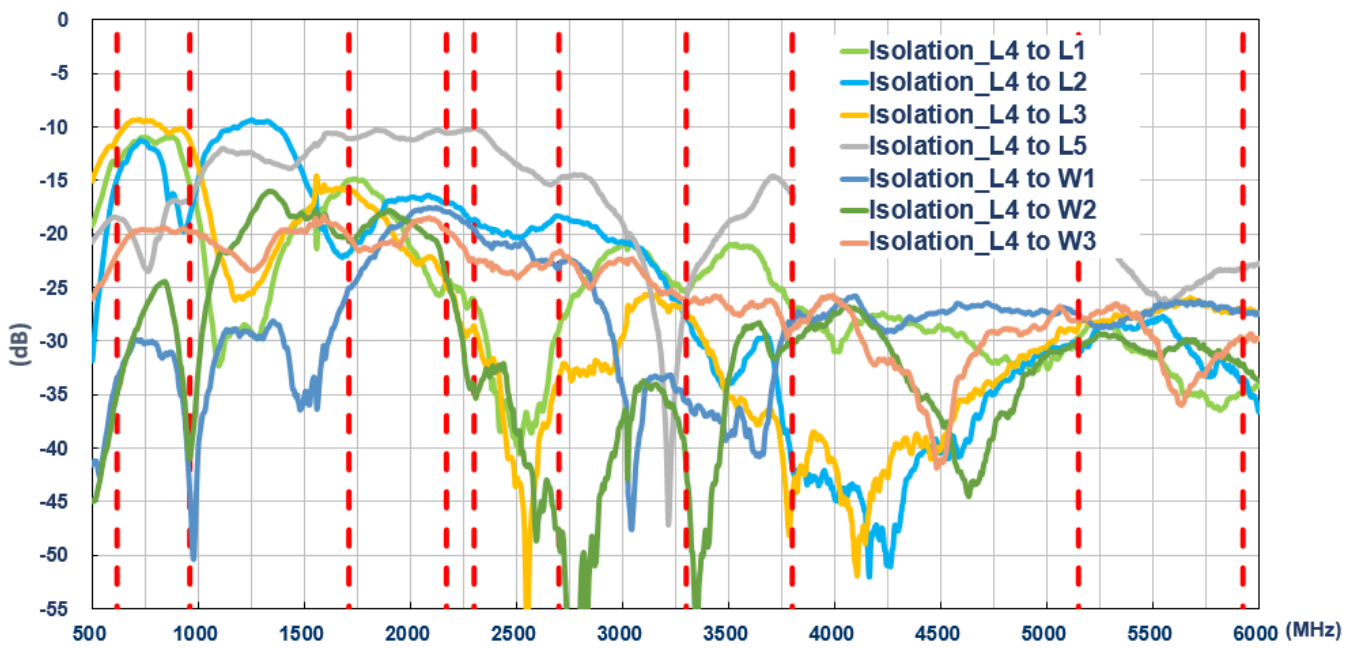

5G/4G 5

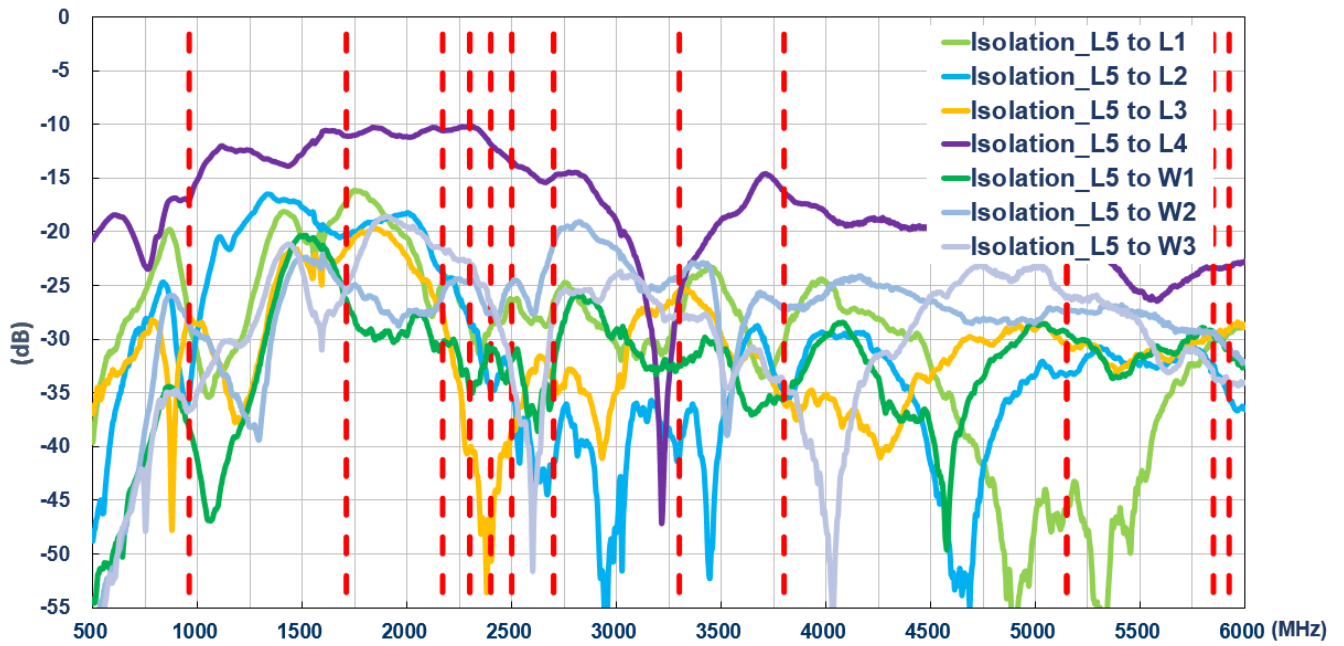

Wi-Fi 1

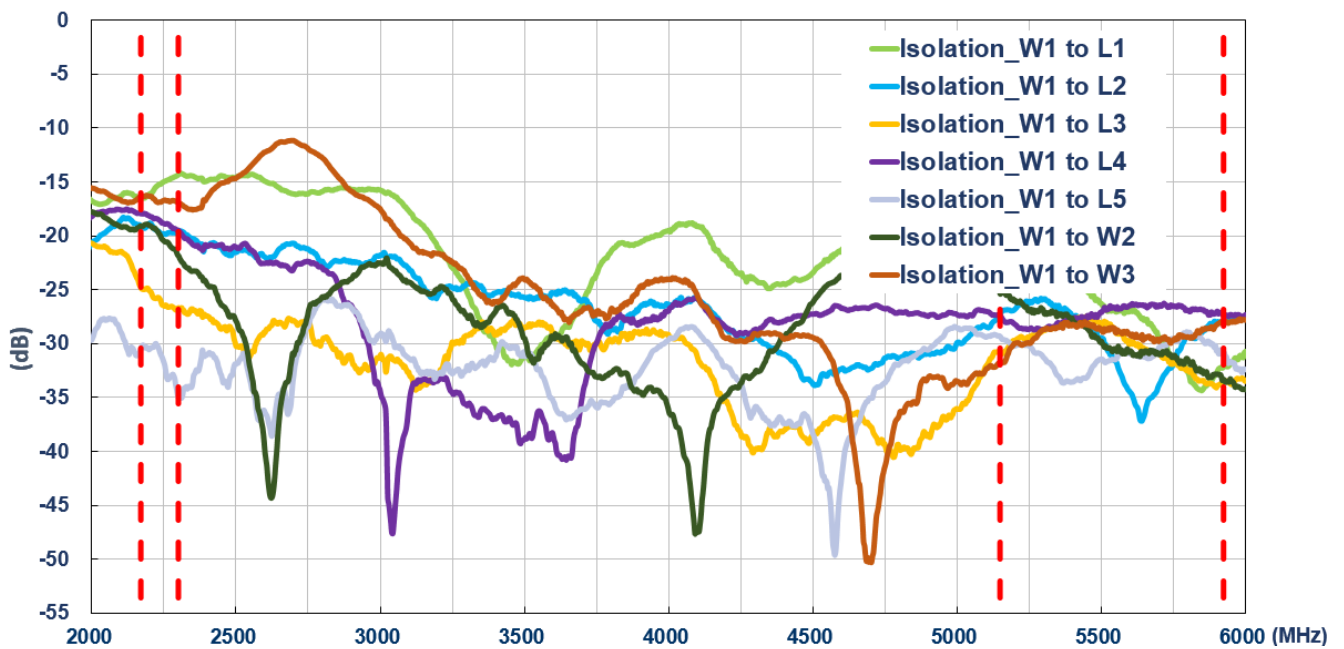

Wi-Fi 2

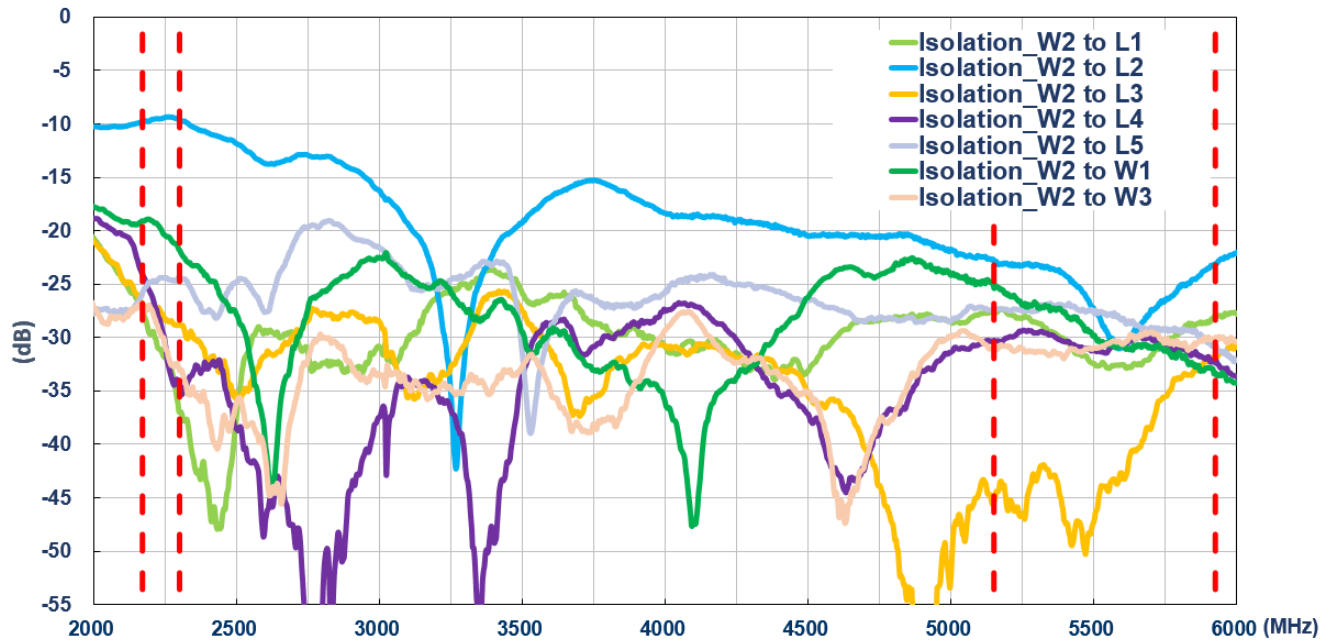

Wi-Fi 3

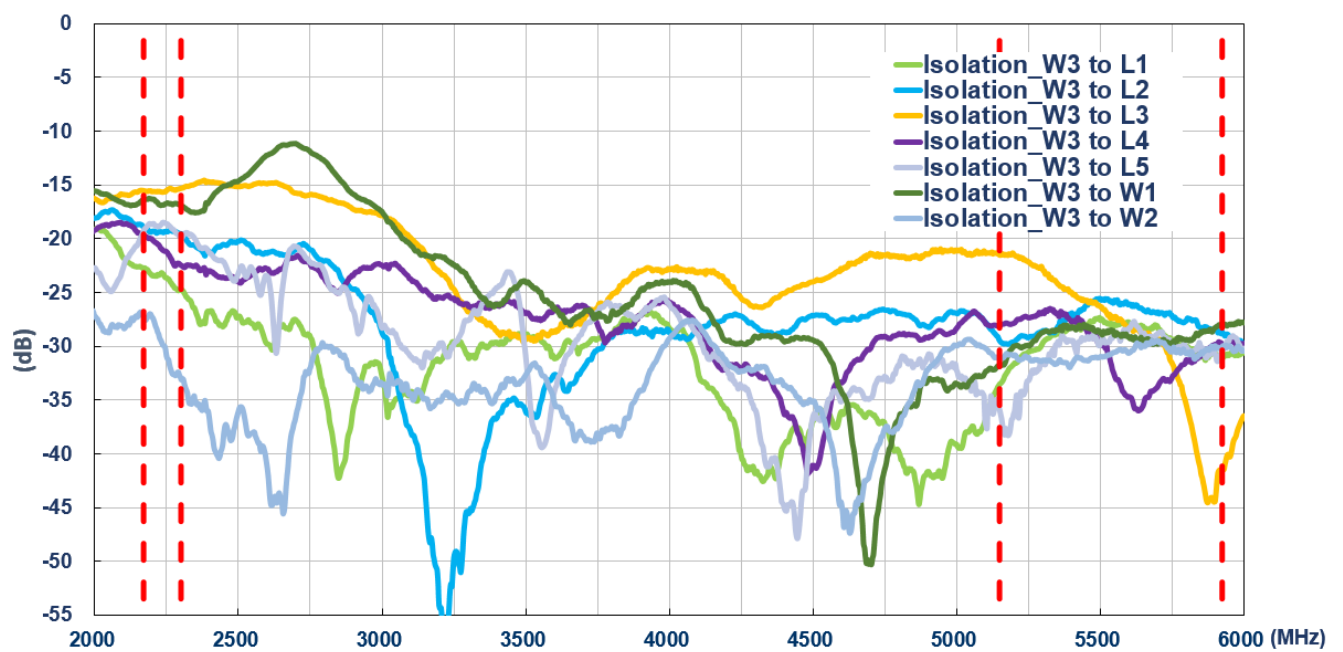

4.3 Efficiency

5G/4G MIMO

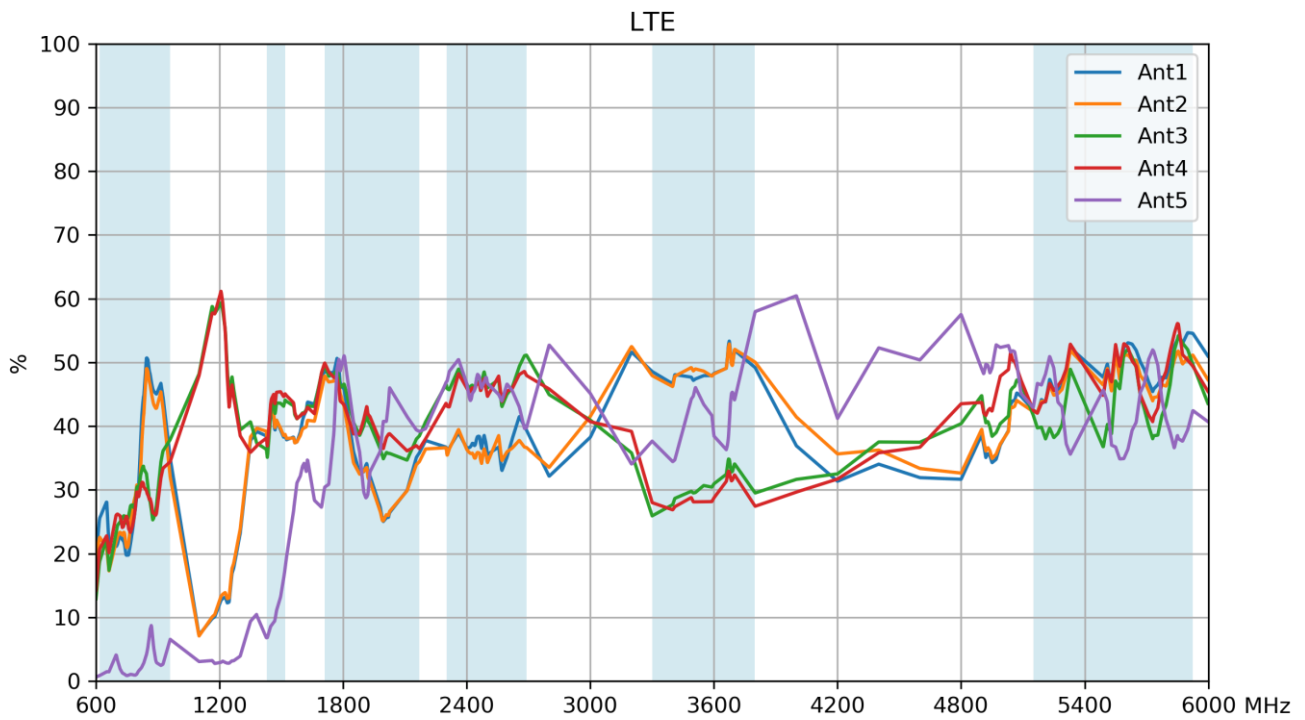

Wi-Fi MIMO

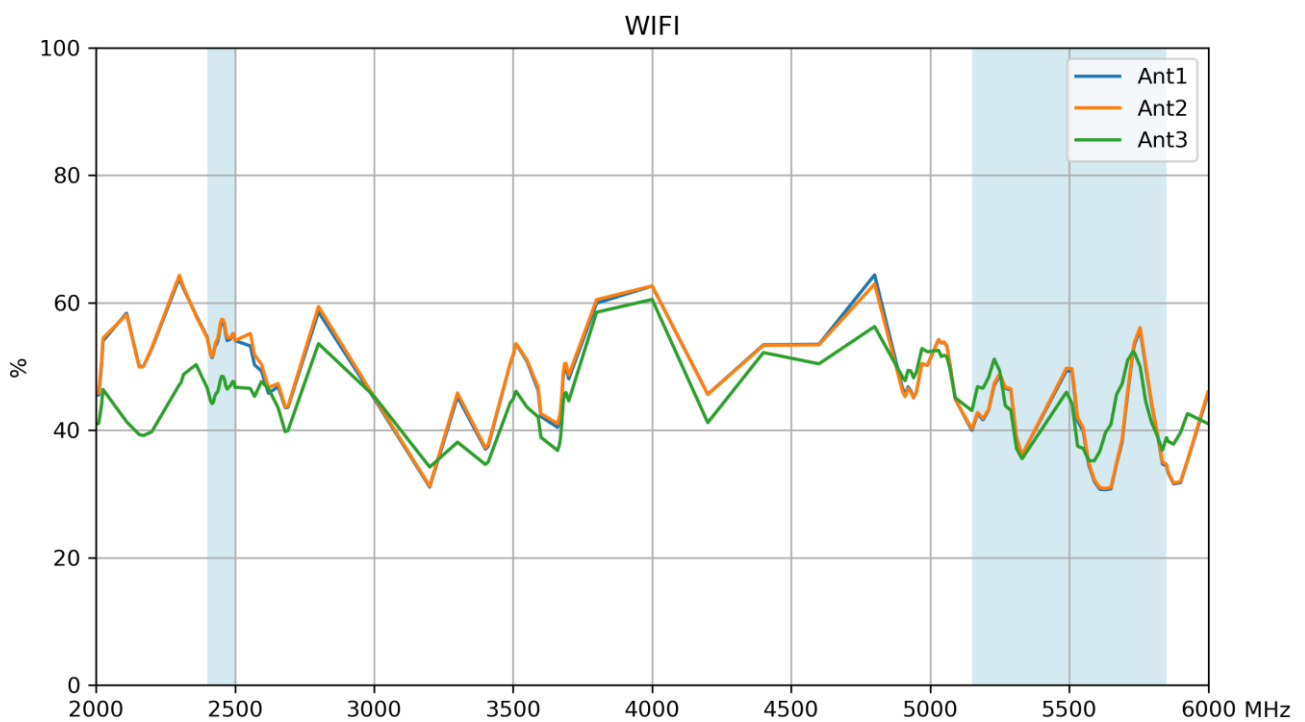

4.4 Average Gain

5G/4G MIMO

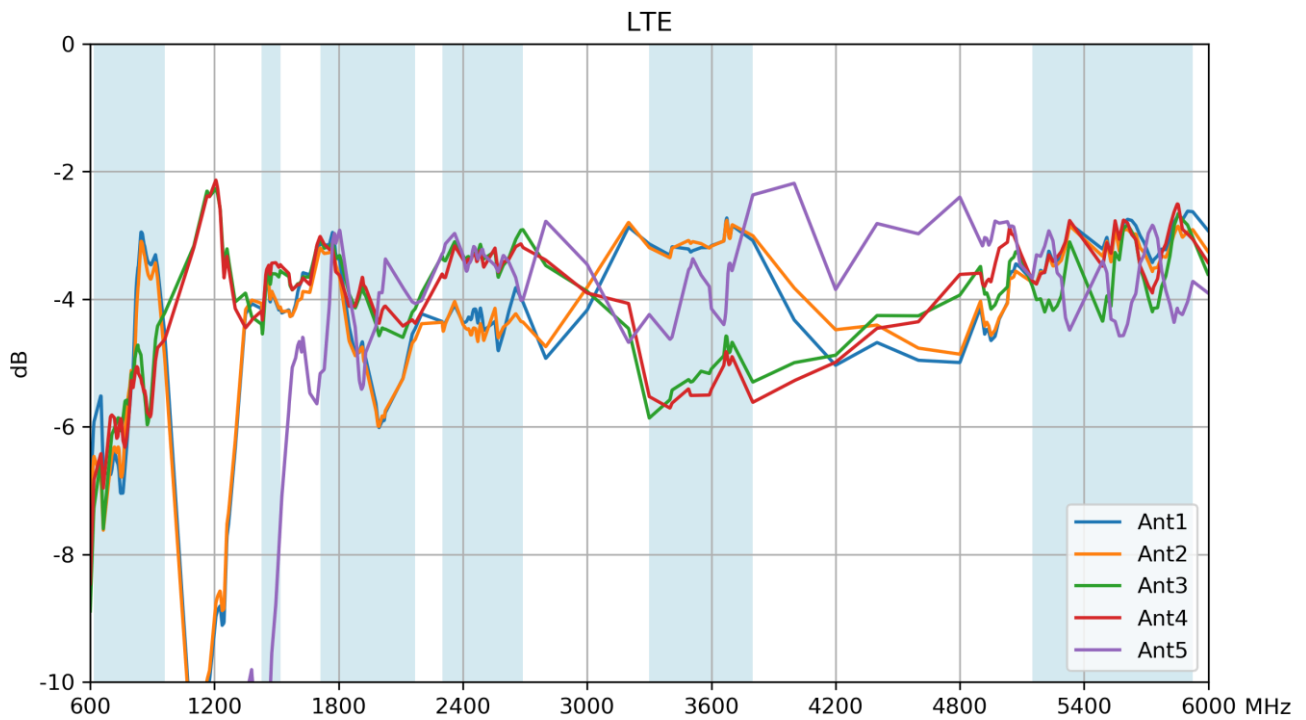

Wi-Fi MIMO

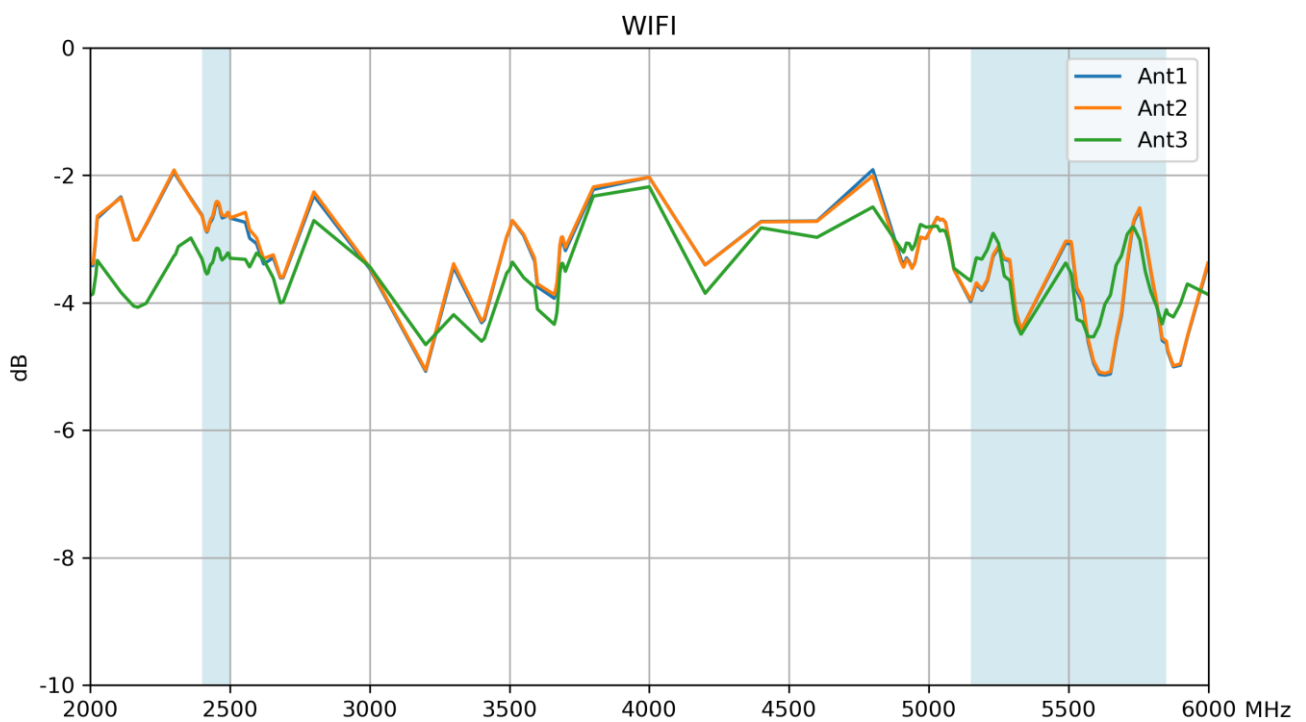

4.5 Peak Gain

5G/4G MIMO

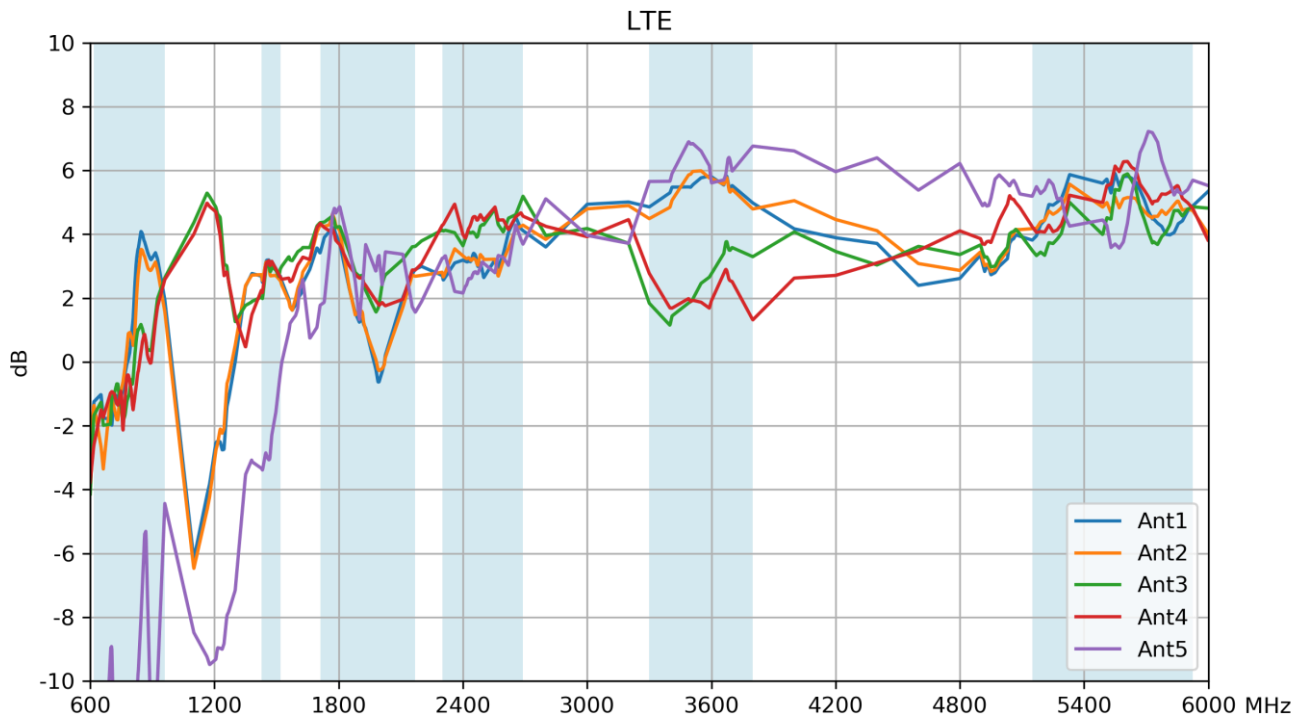

Wi-Fi MIMO

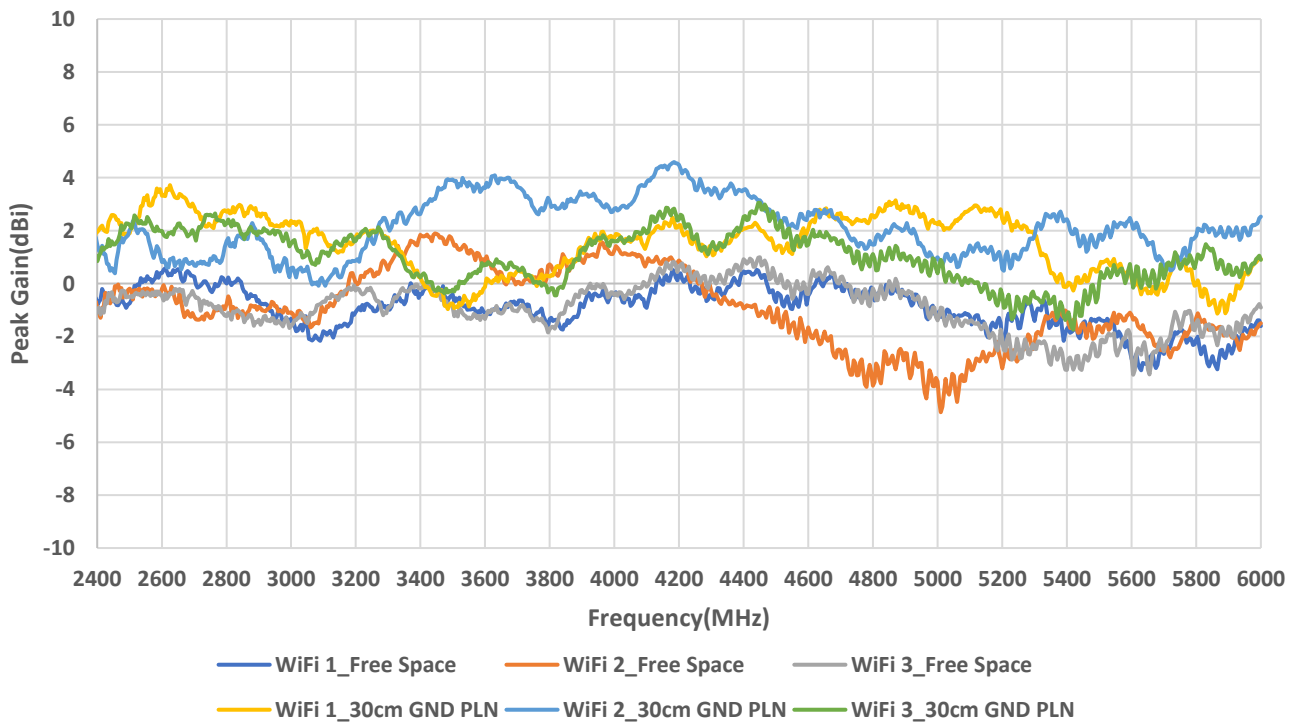

5. Radiation Patterns

5.1 Test Setup

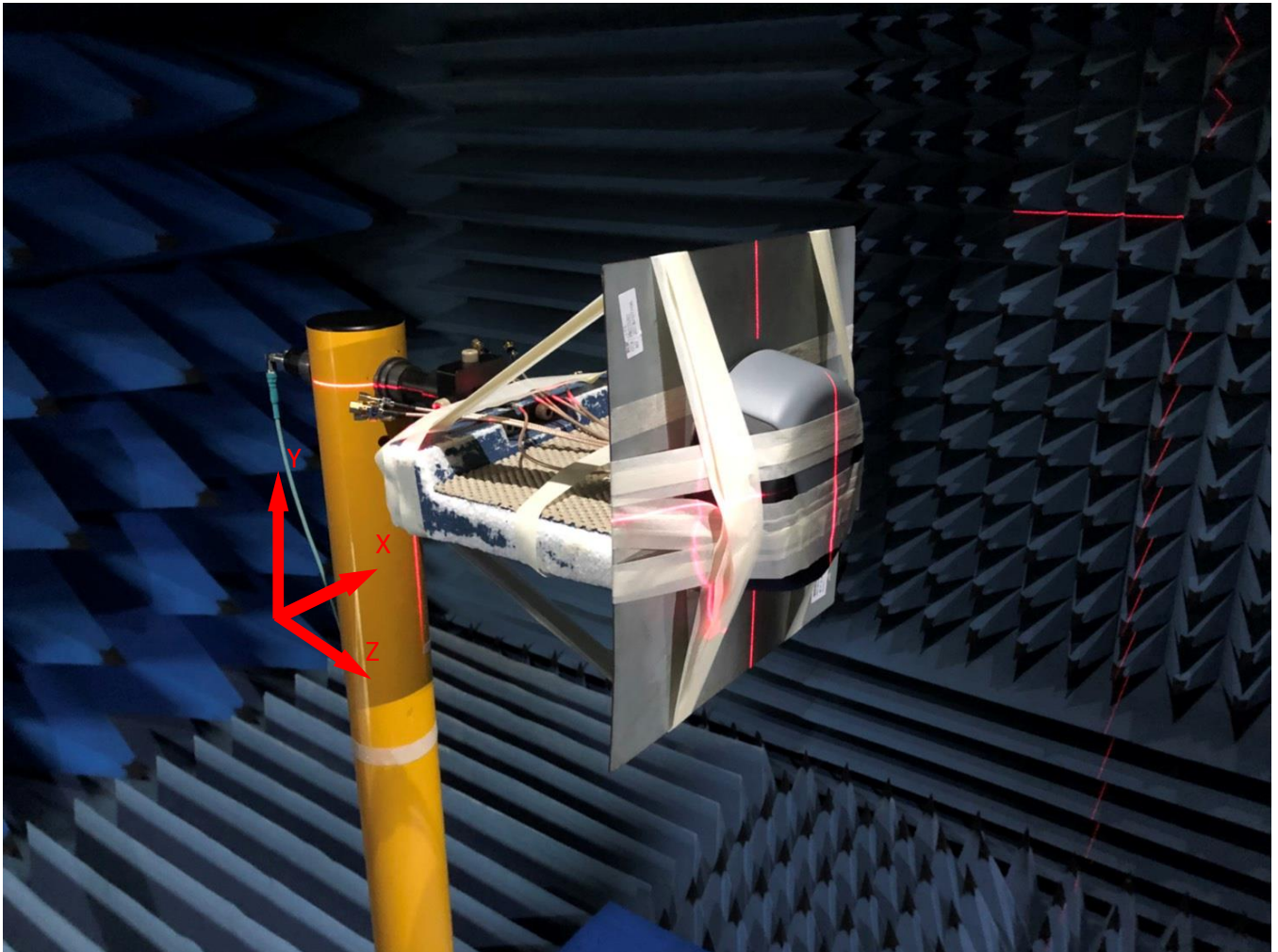

On 30x30cm Ground Plane

5.2 5G/4G MIMO 1 Radiation Pattern

652MHz

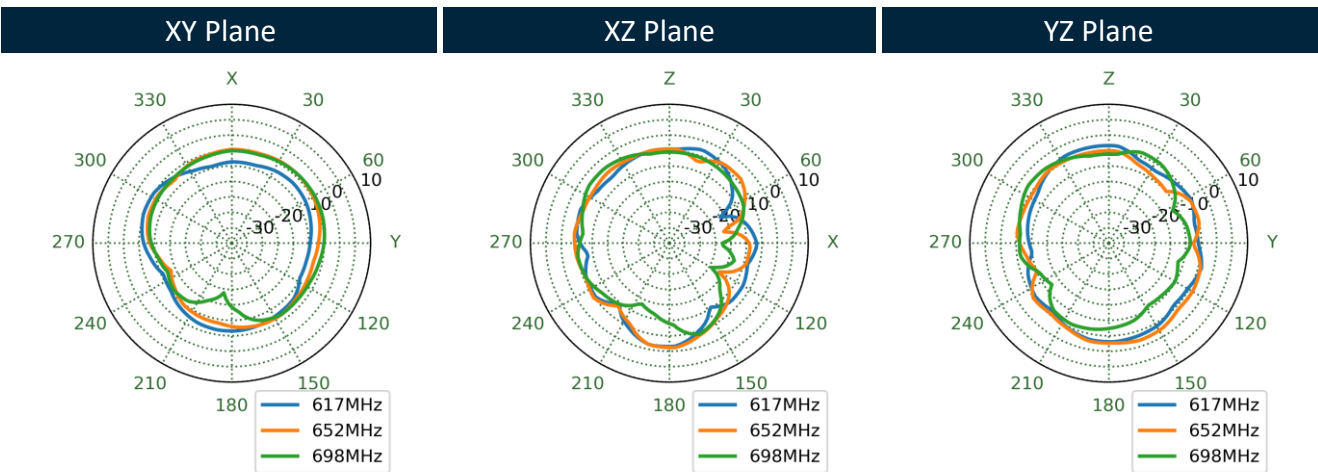
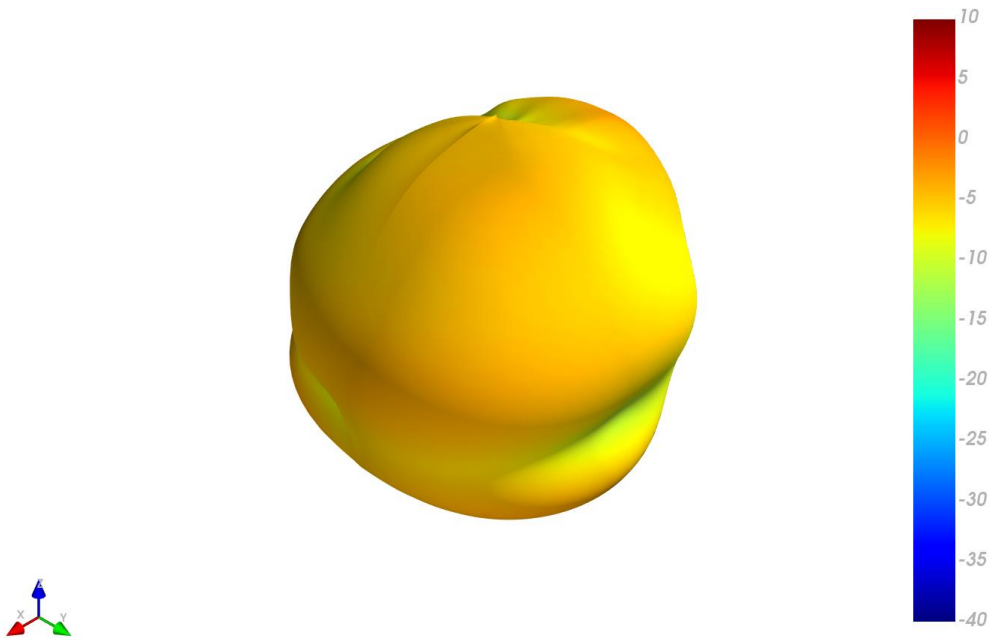

751MHz

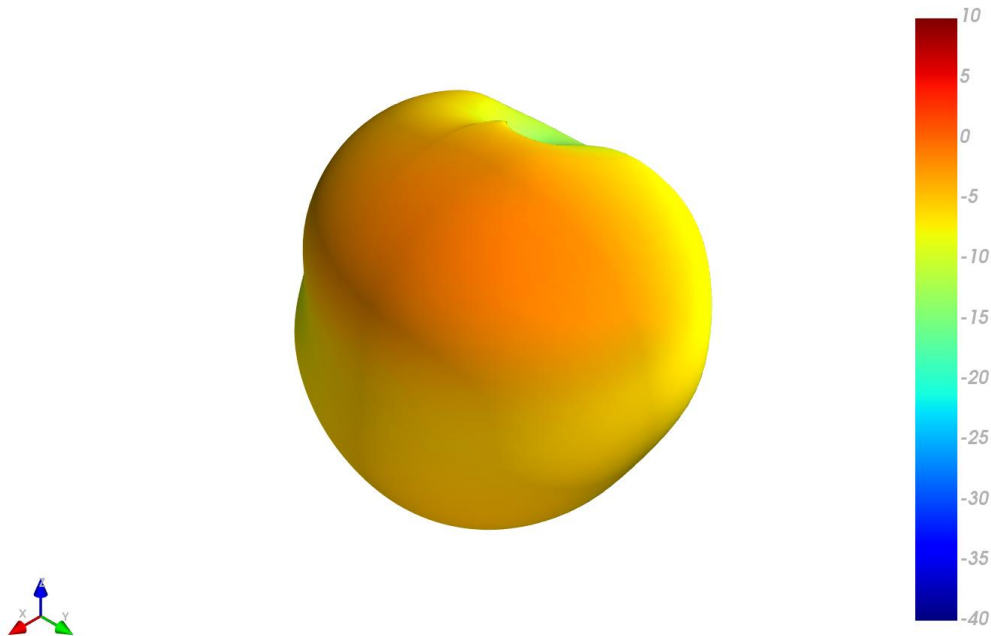

XY Plane XZ Plane YZ Plane

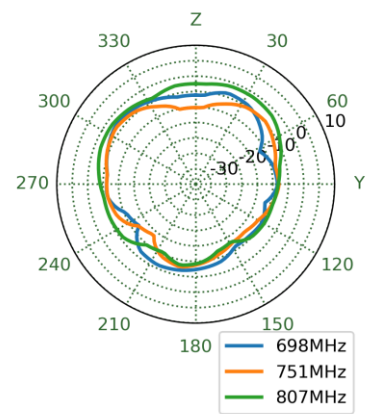
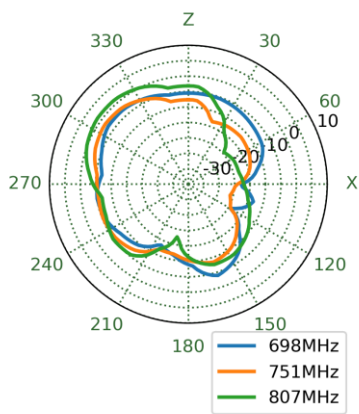
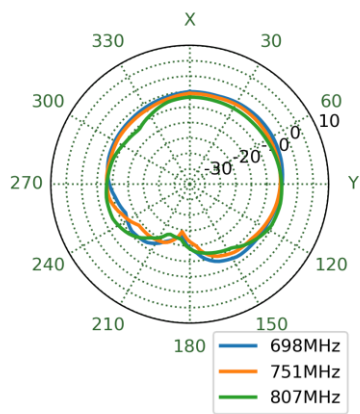

890MHz

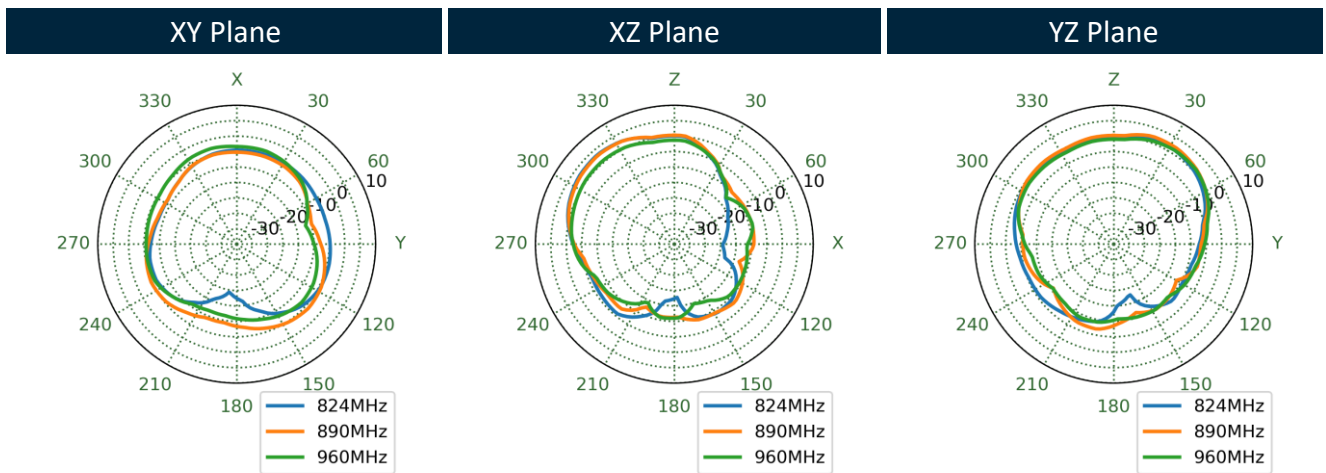
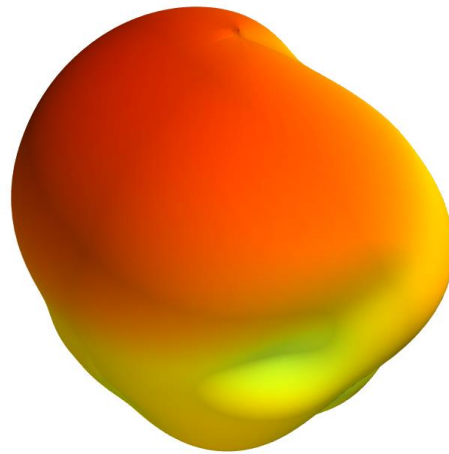

1470MHz

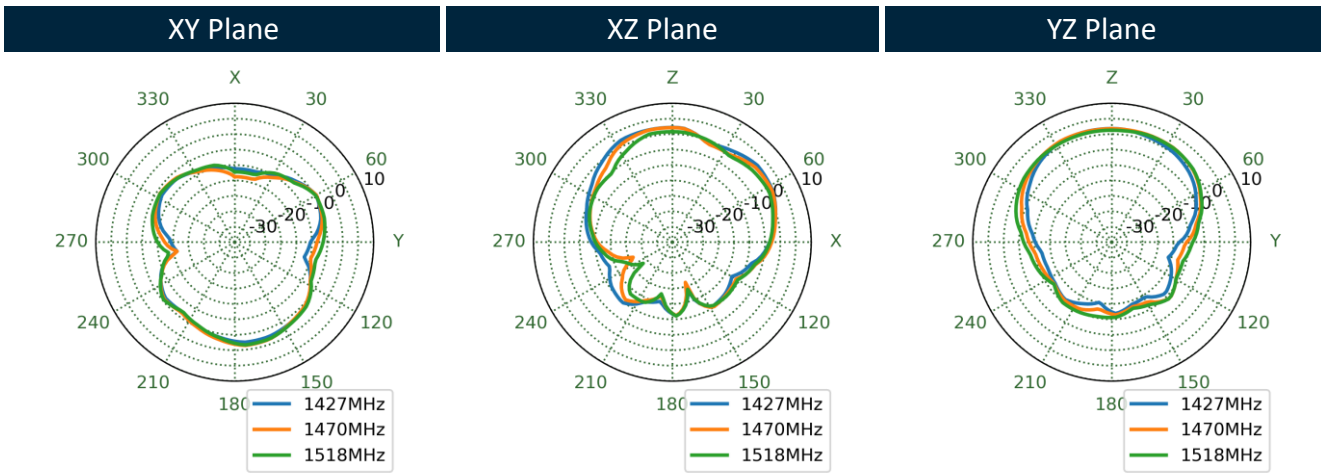
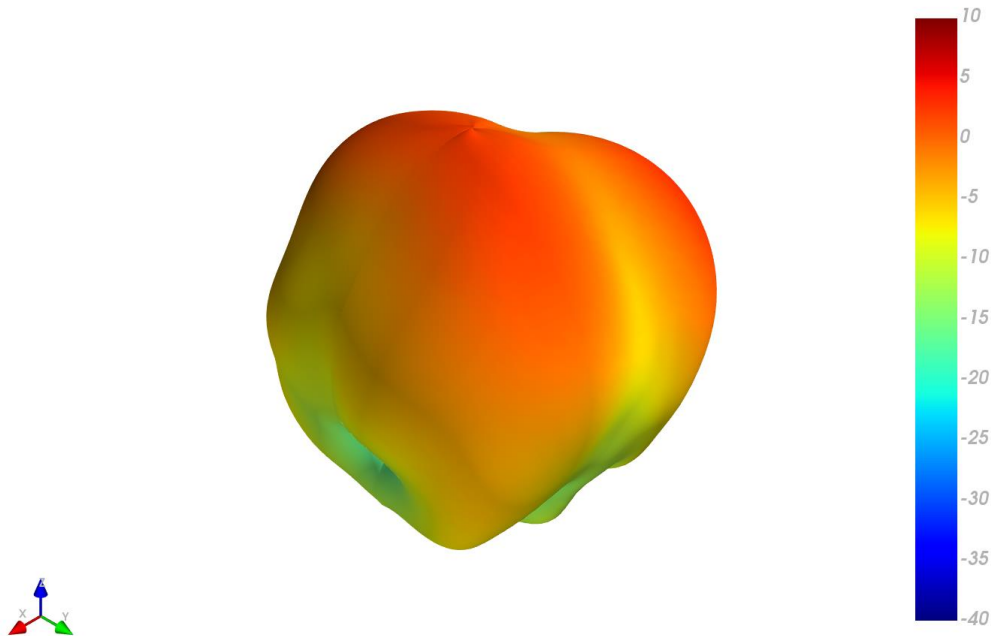

1805MHz

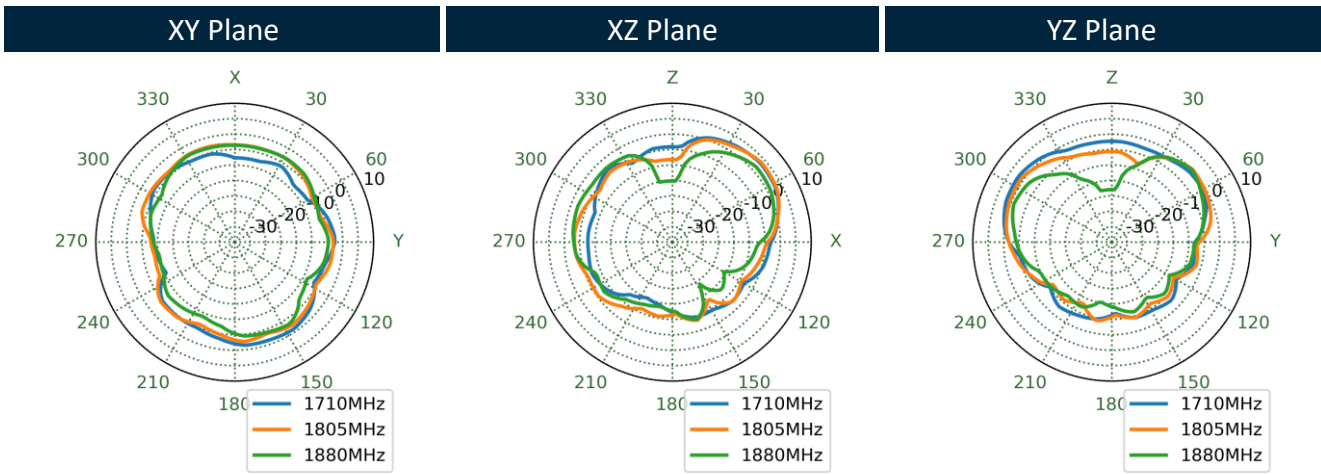
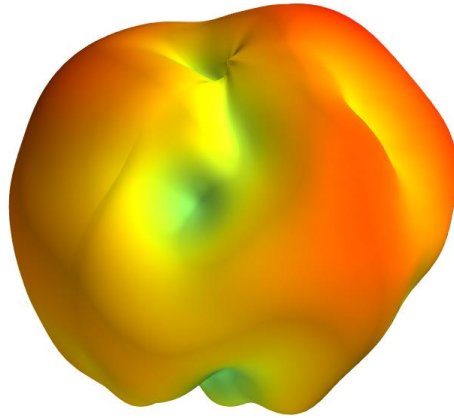

1920MHz

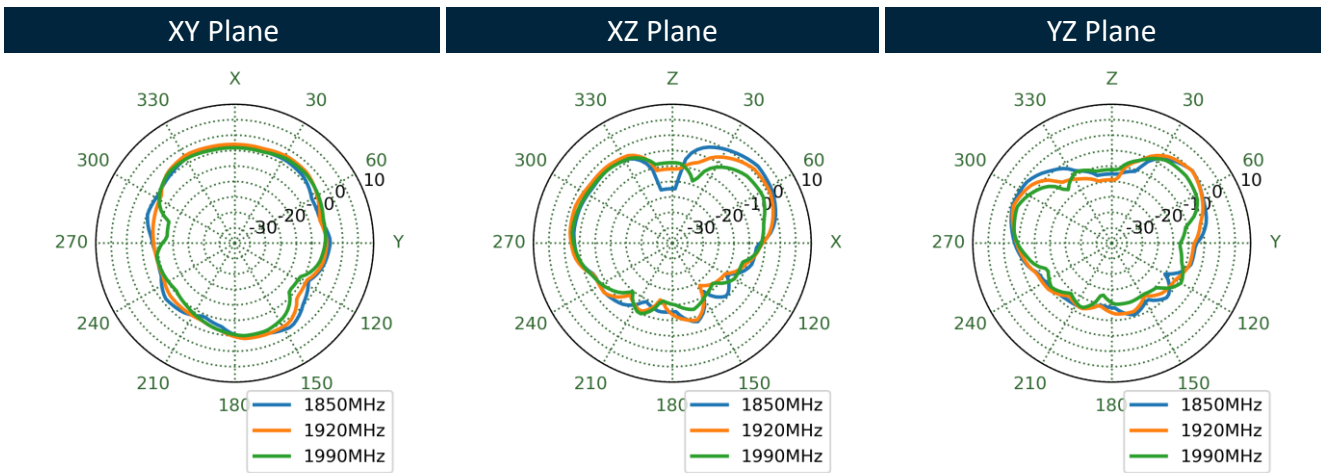
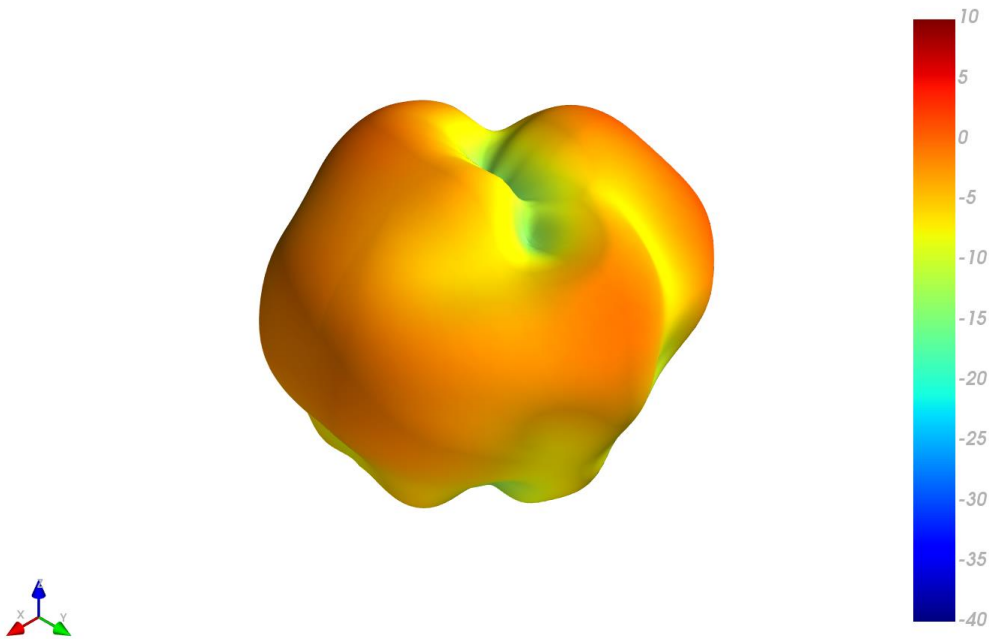

1990MHz

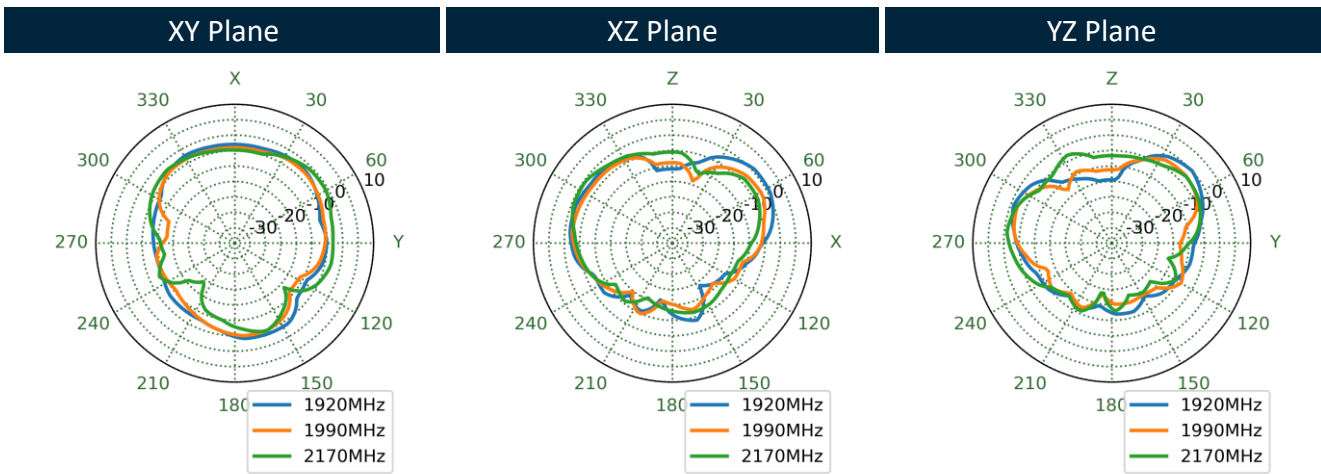
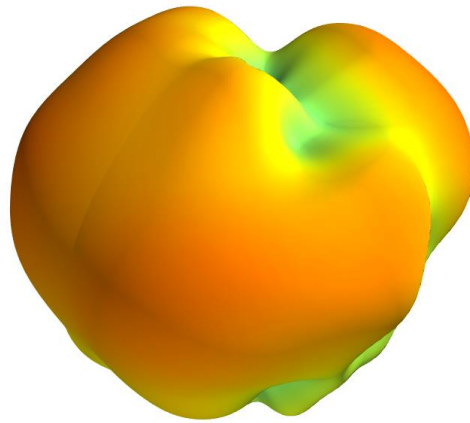

2595MHz

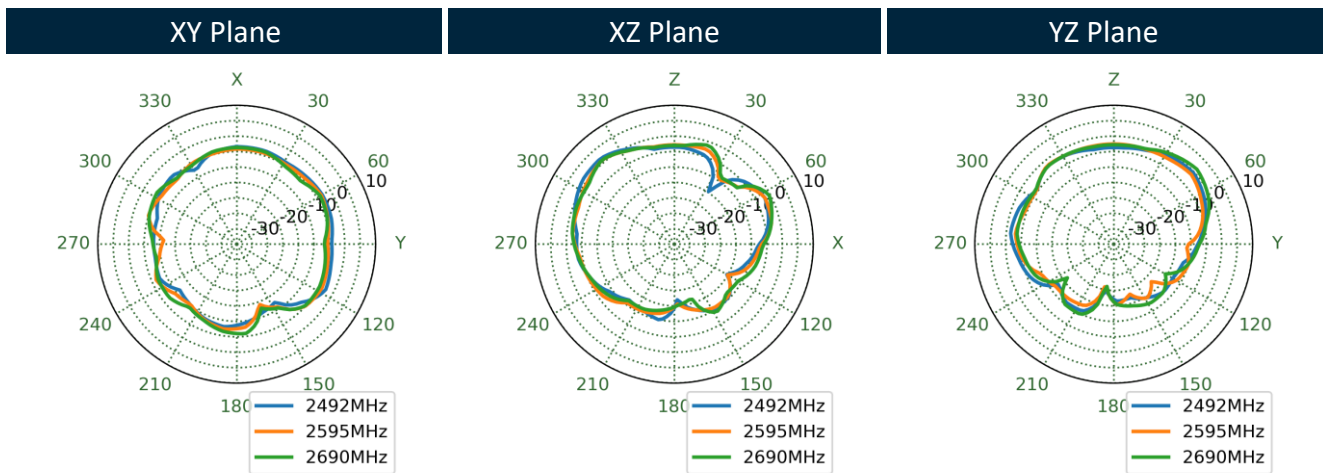
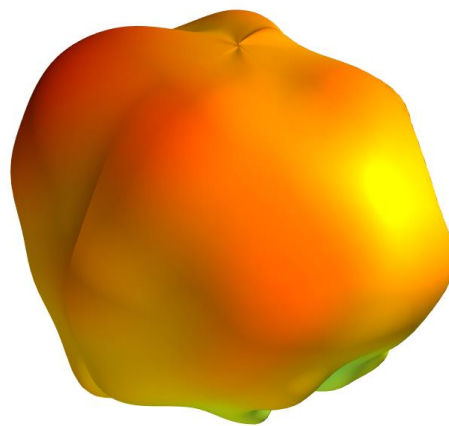

3550MHz

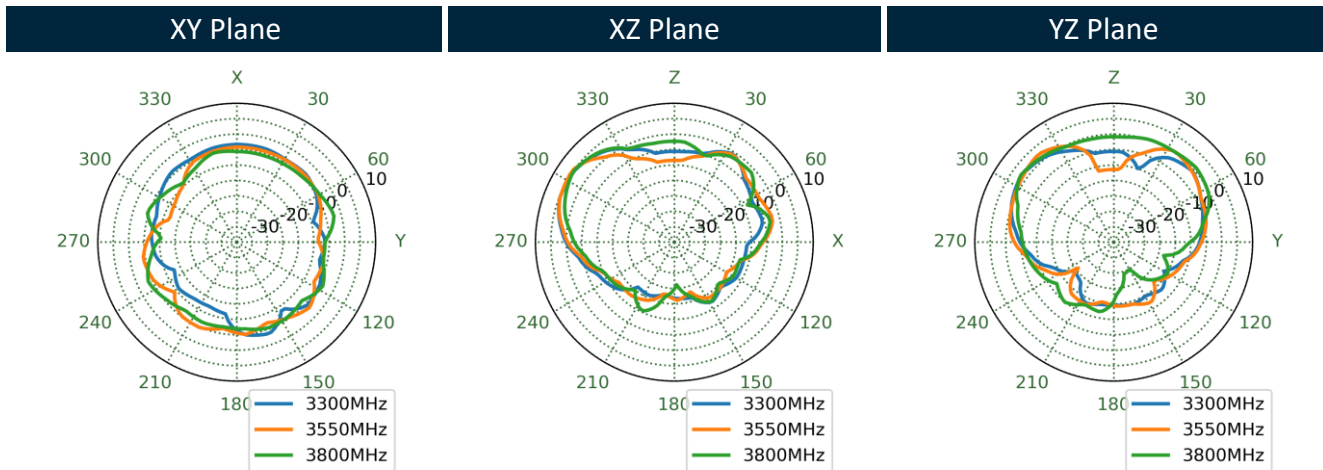
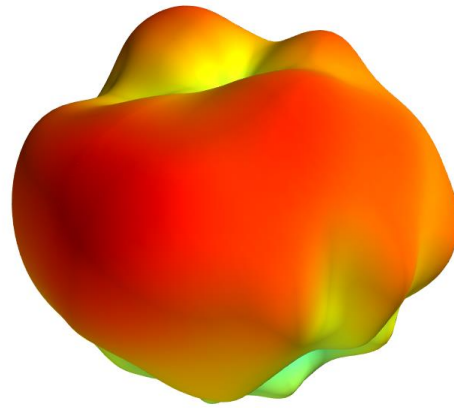

5530MHz

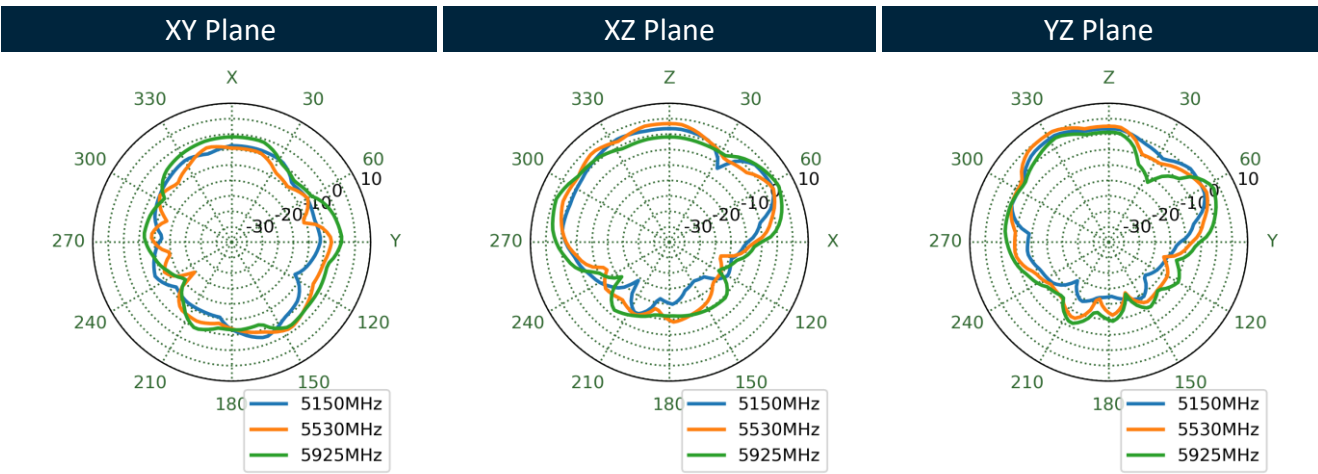
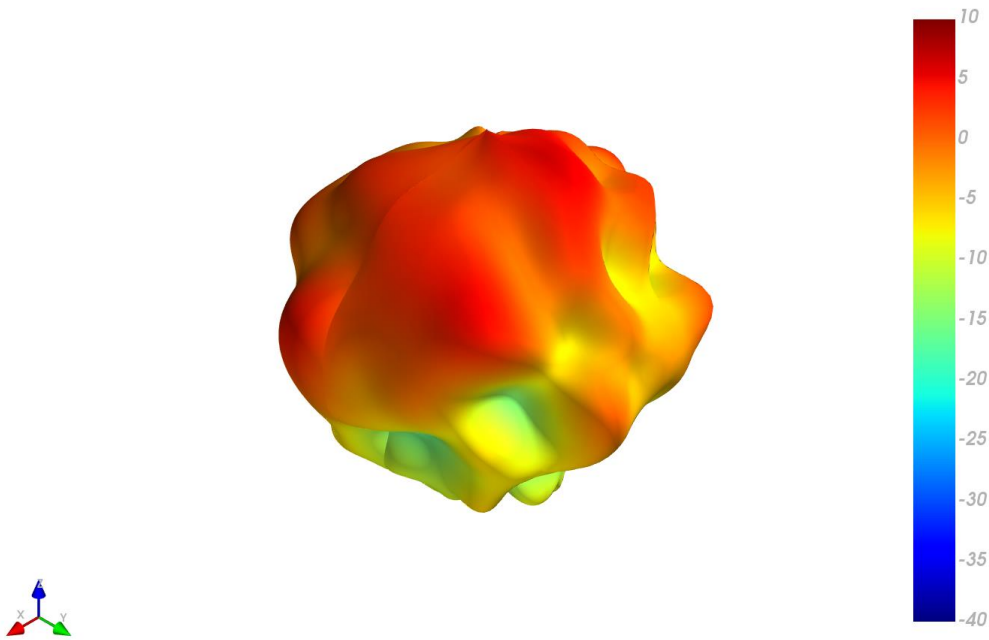

5.3 5G/4G MIMO 2 Radiation Pattern

652MHz

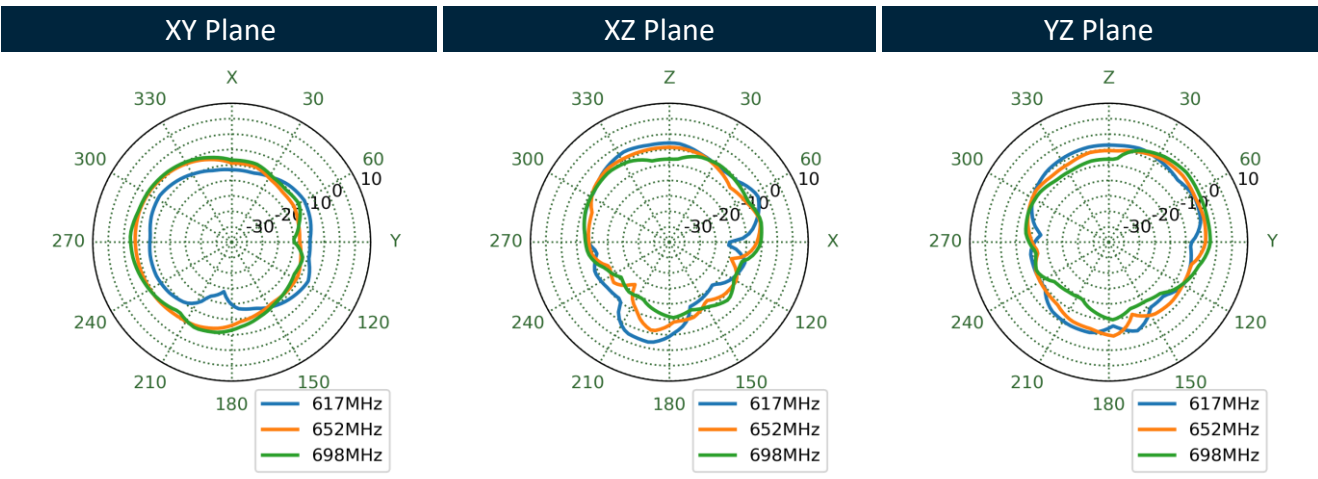
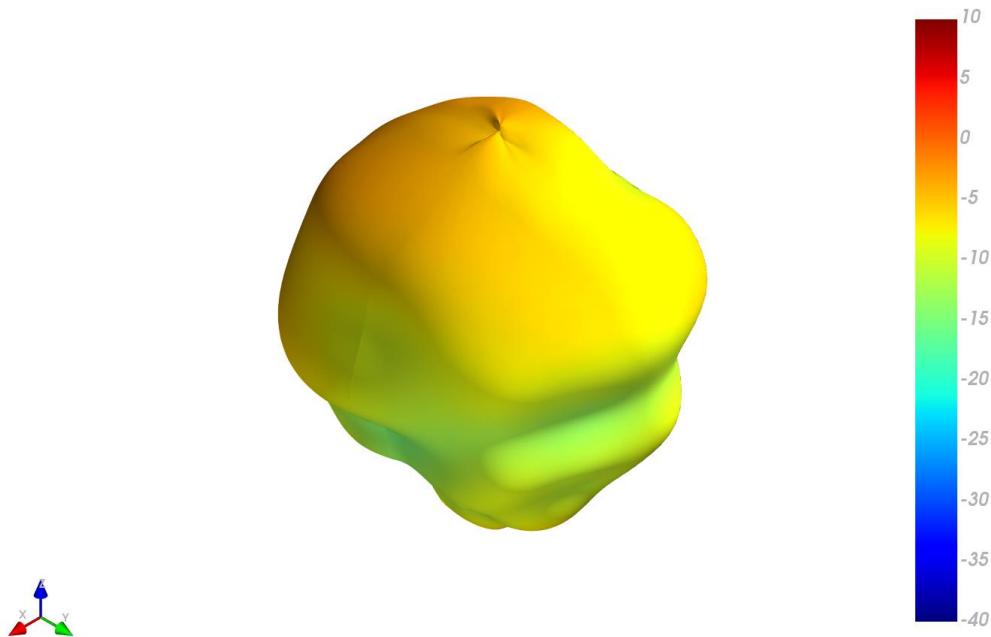

751MHz

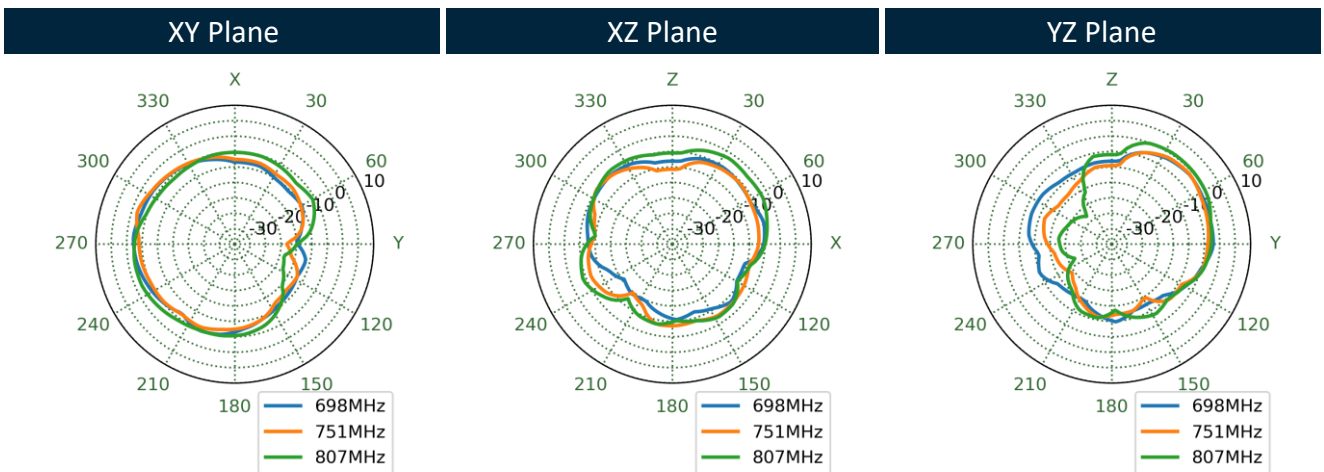
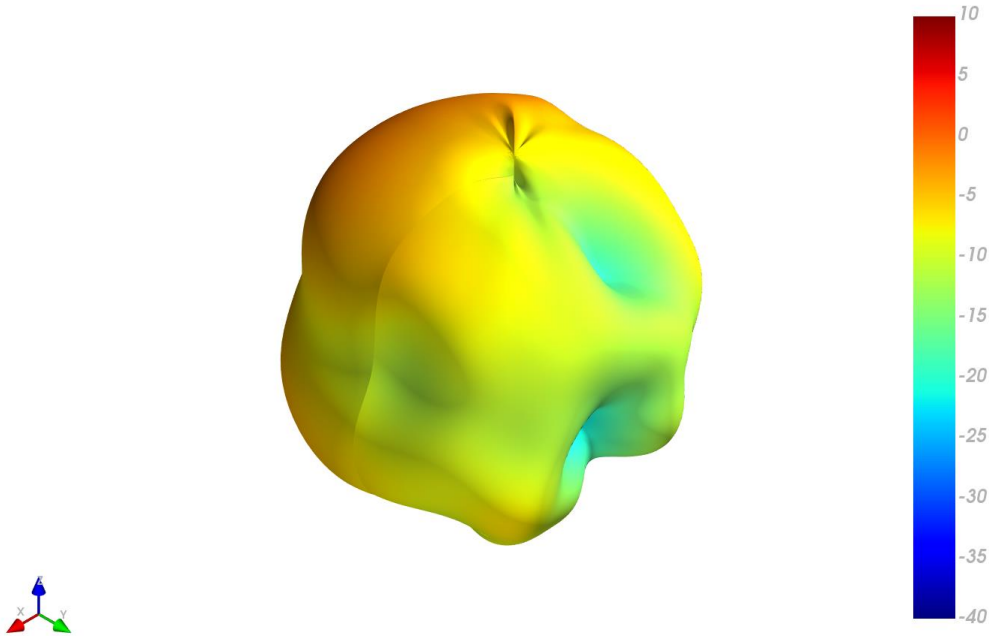

890MHz

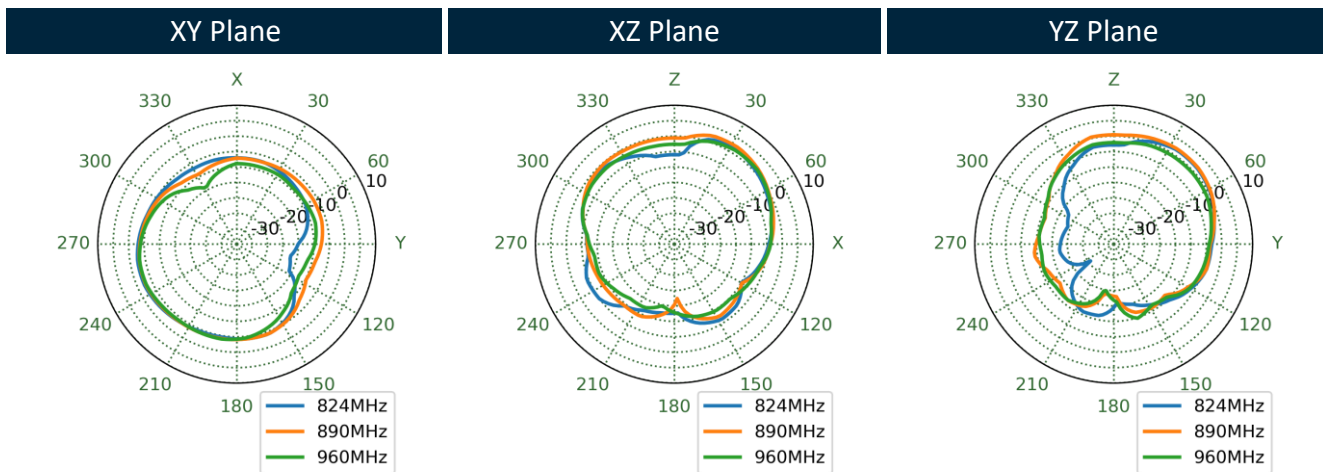
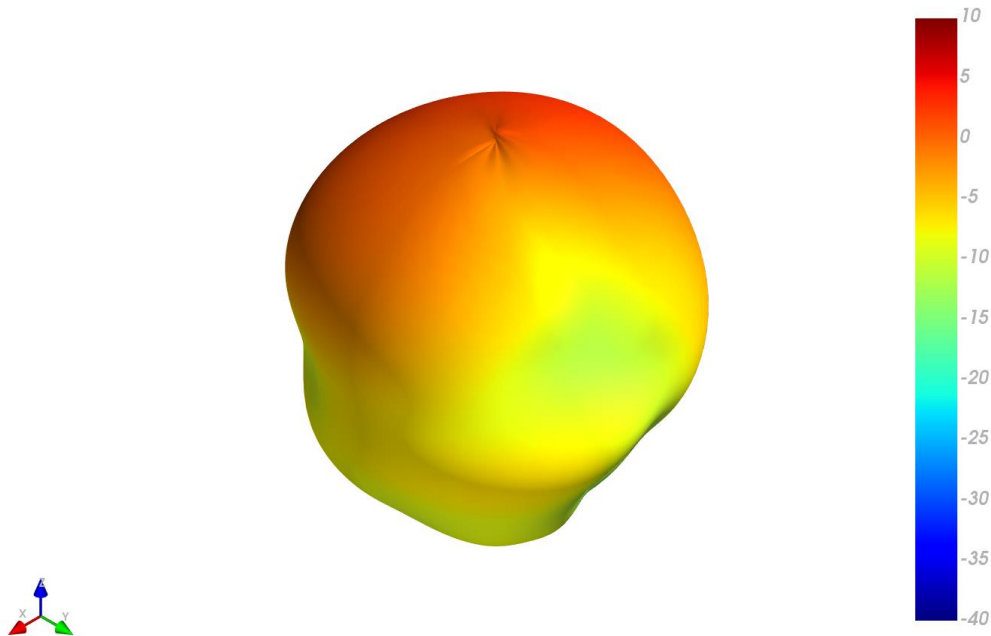

1470MHz

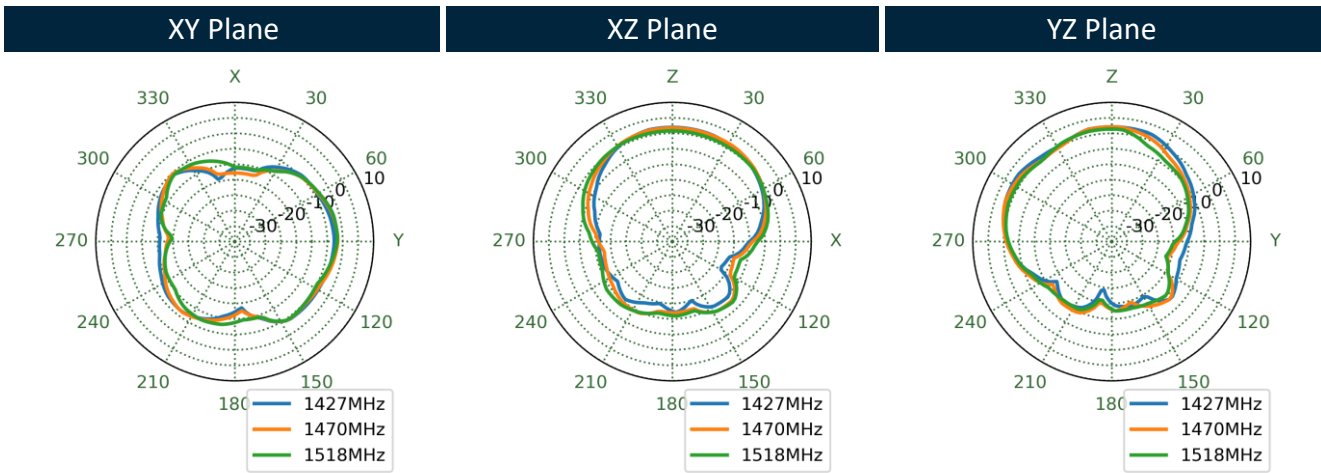
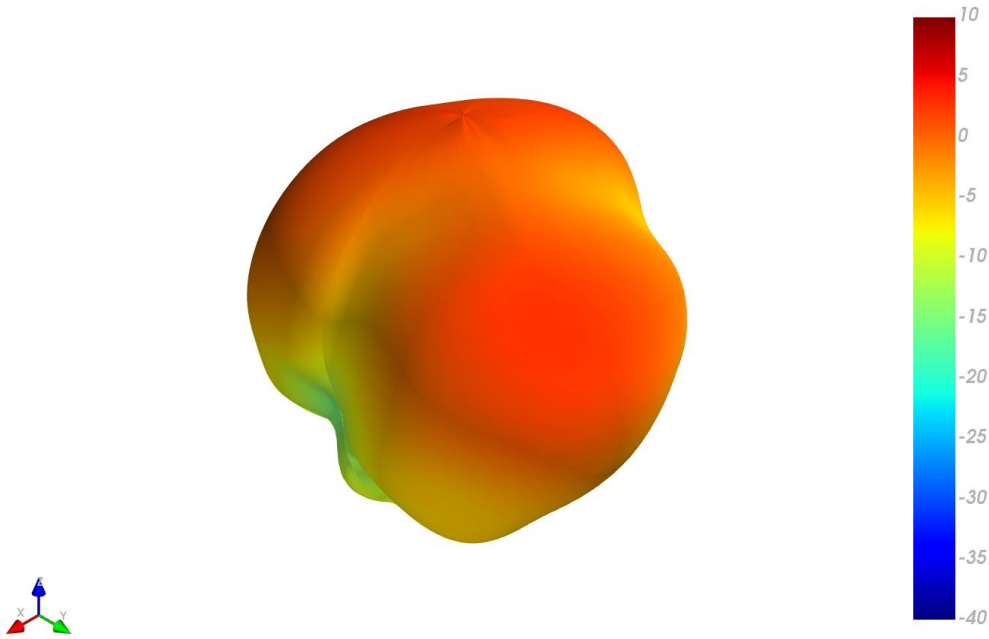

1805MHz

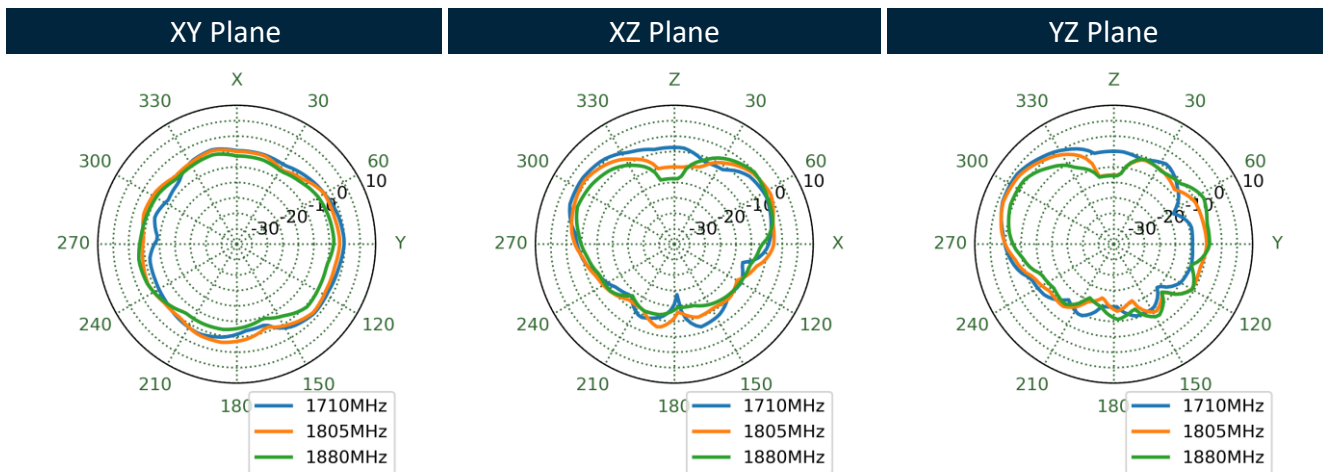
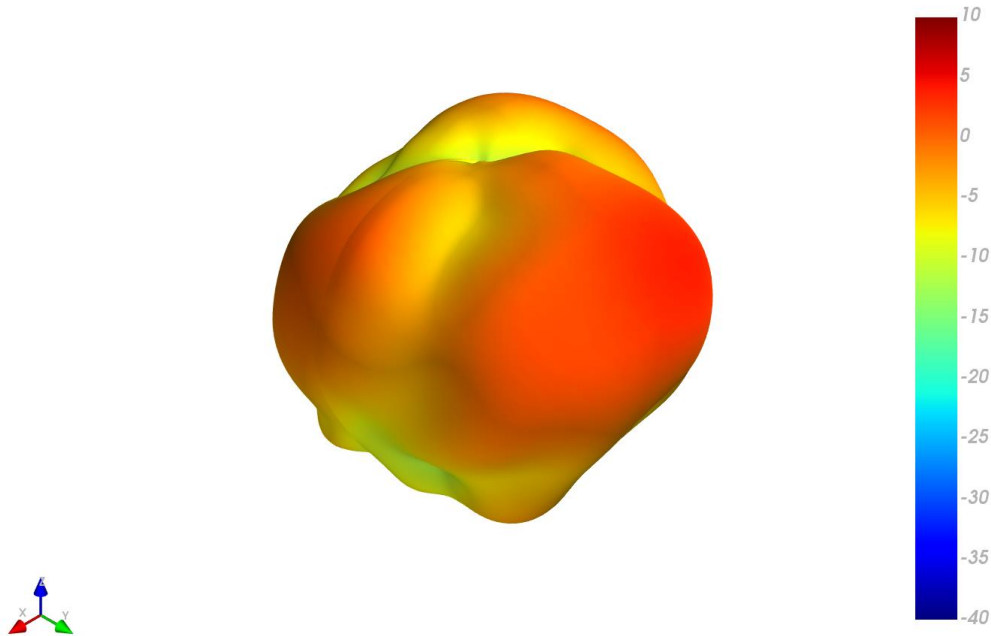

1920MHz

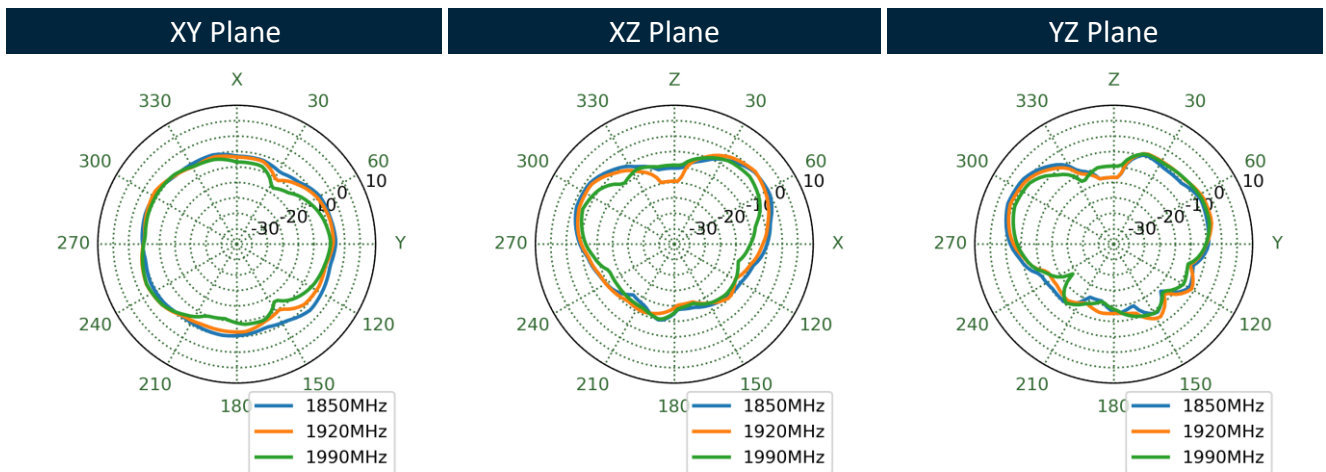
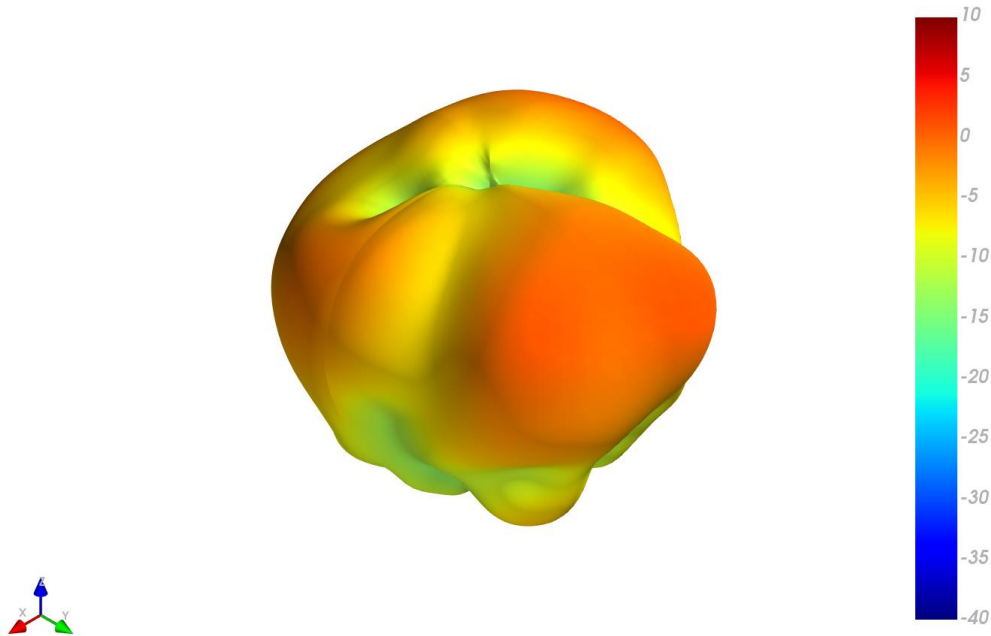

1990MHz

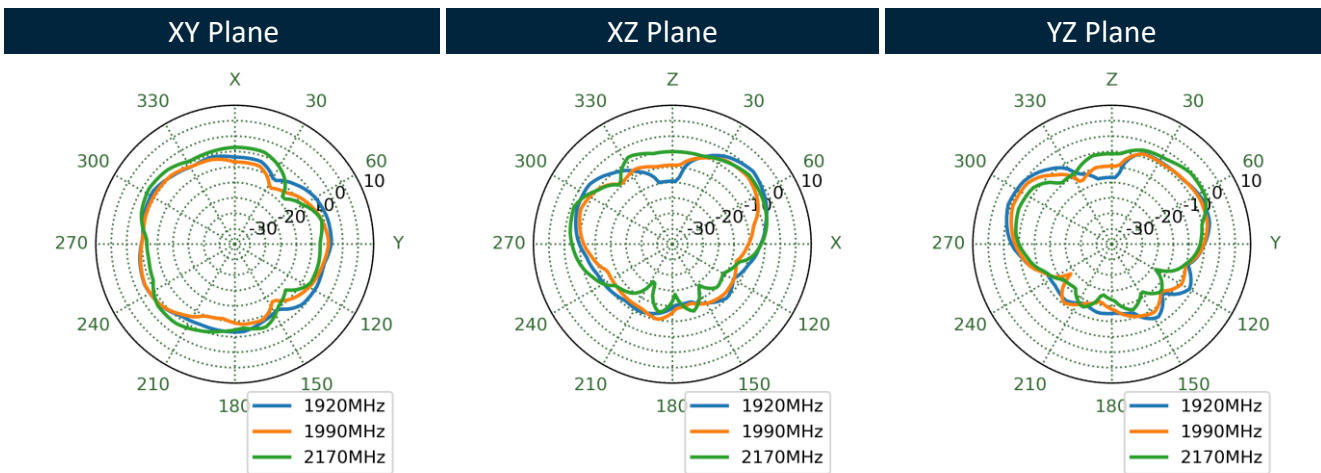
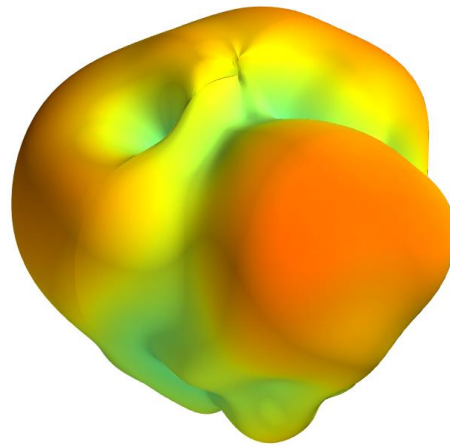

2595MHz

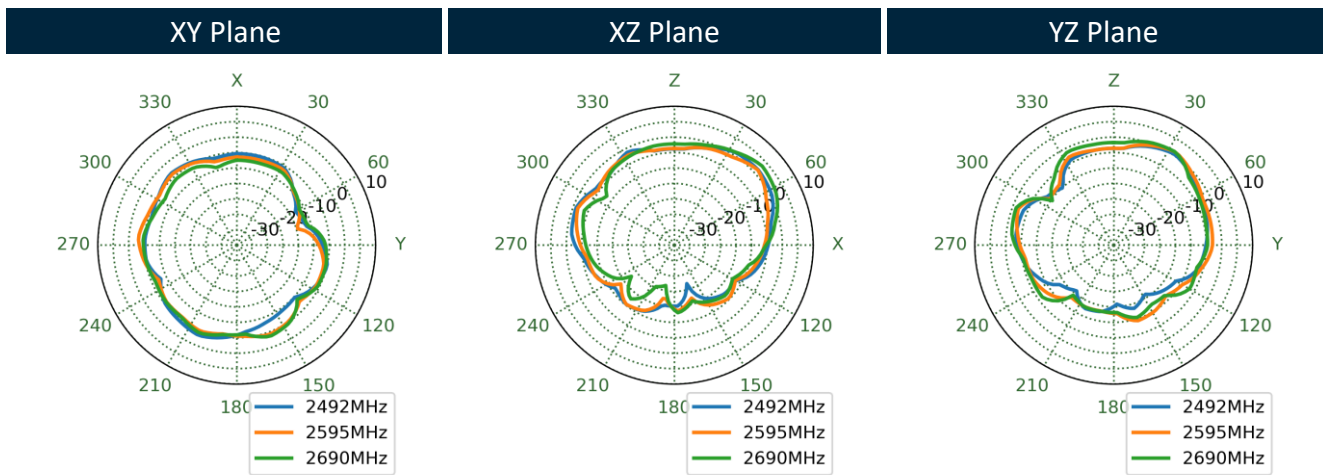
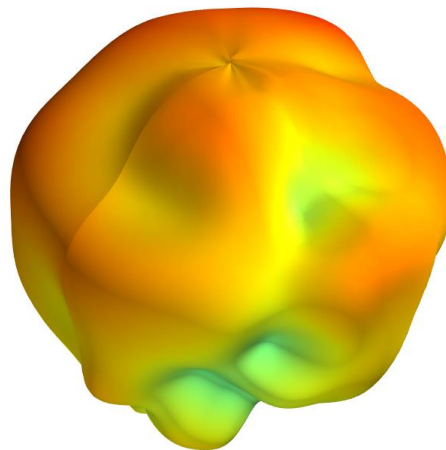

3550MHz

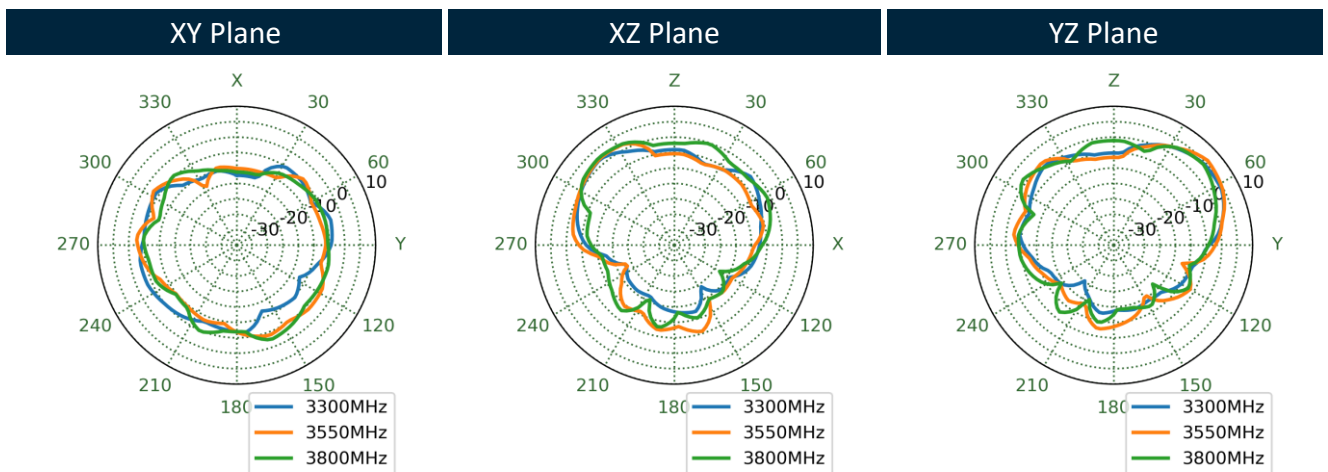
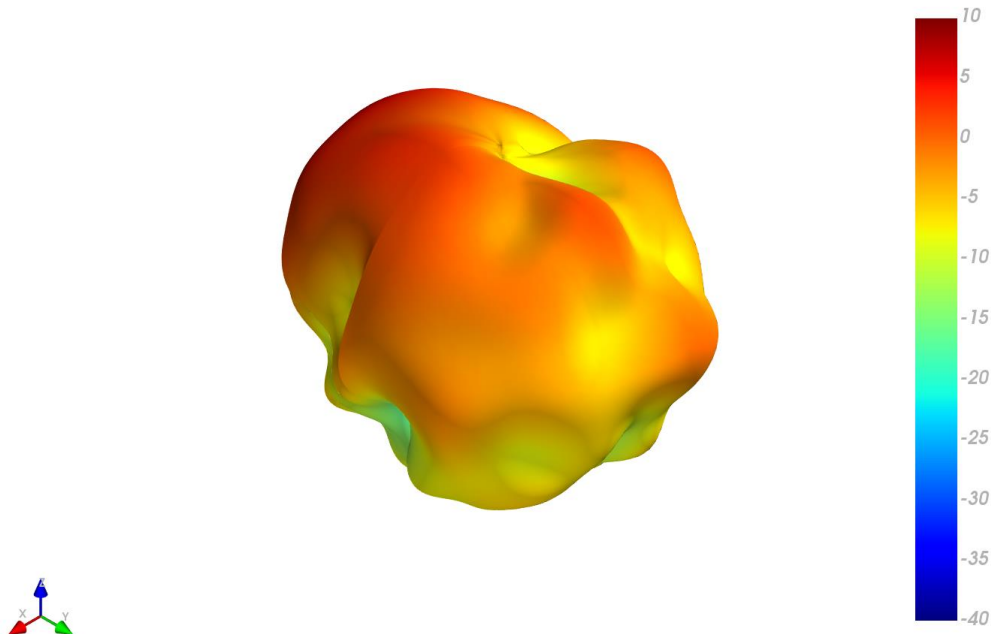

5530MHz

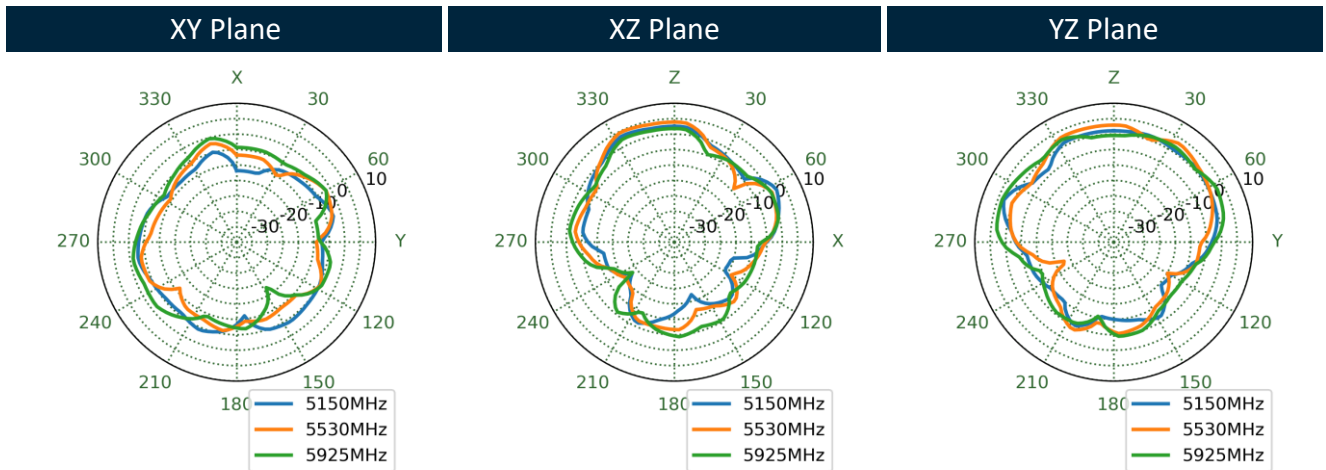
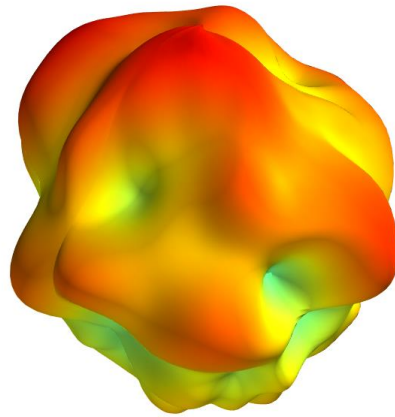

5.4 5G/4G MIMO 3 Radiation Pattern

652MHz

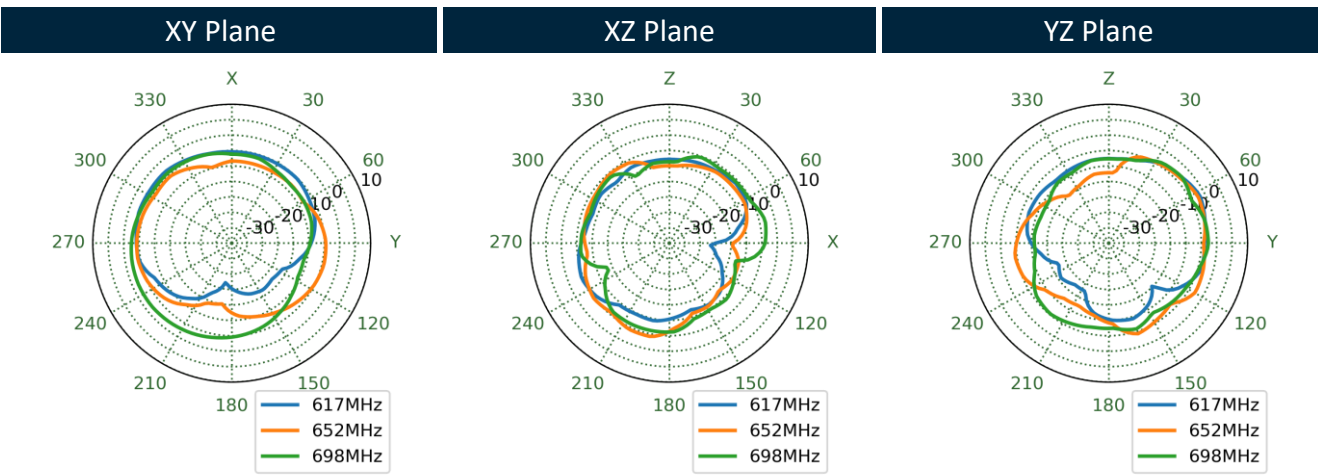
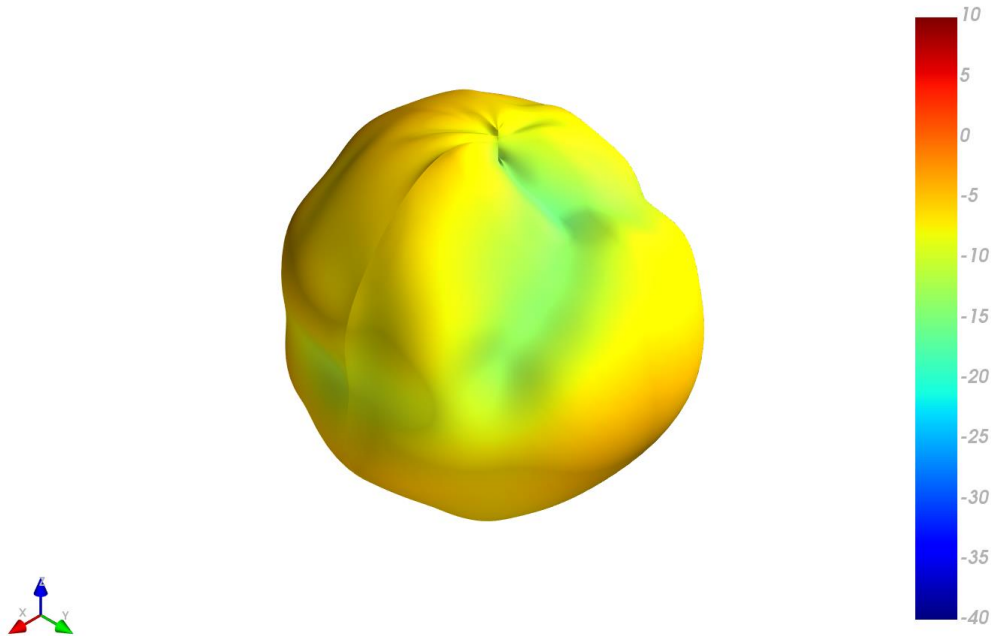

751MHz

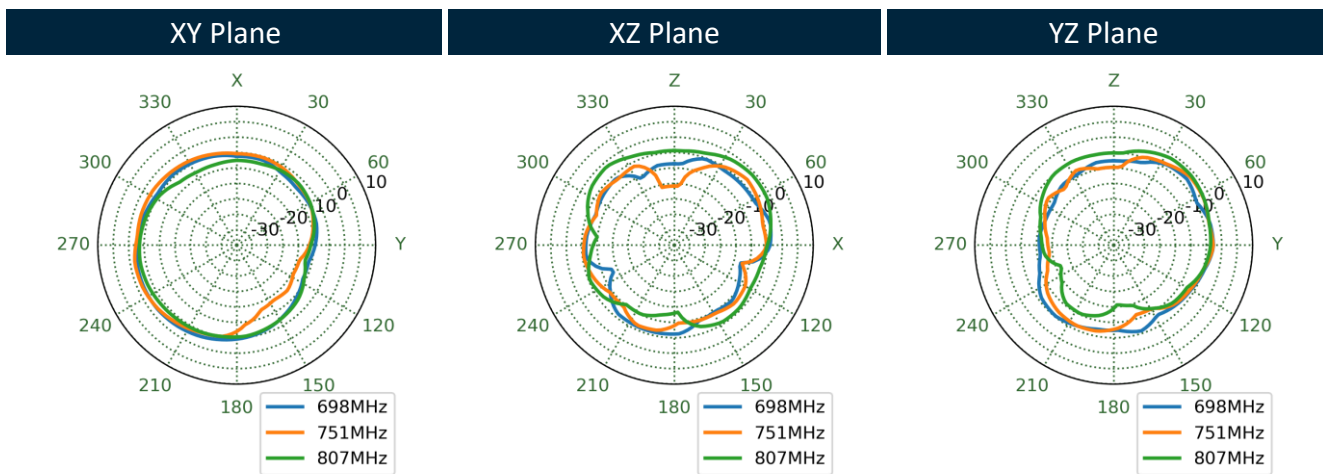
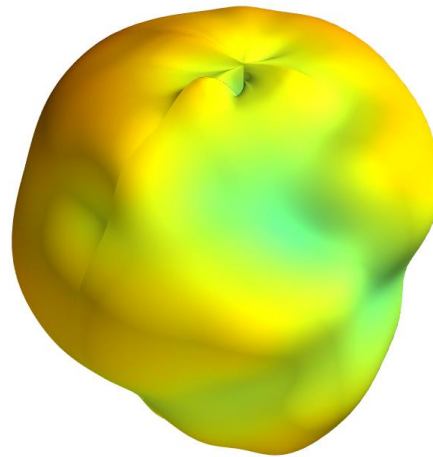

890MHz

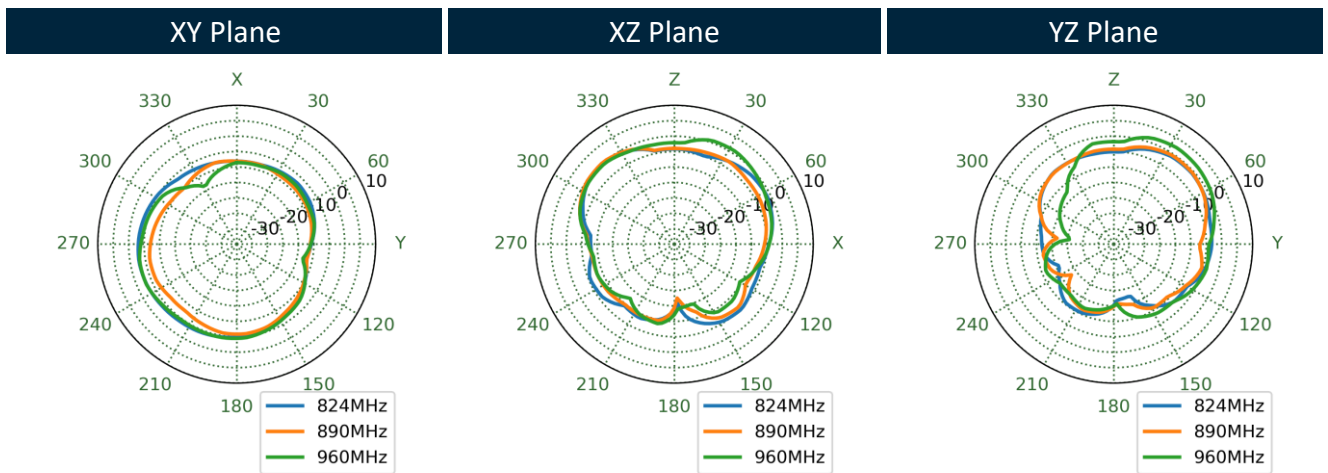
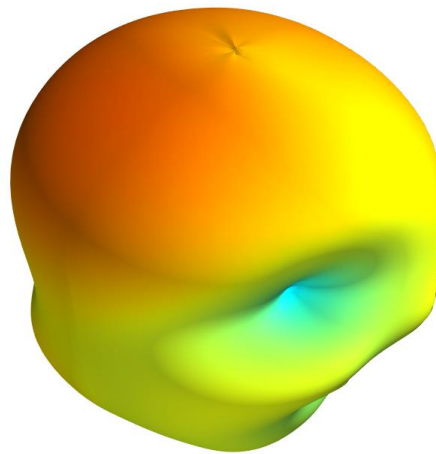

1470MHz

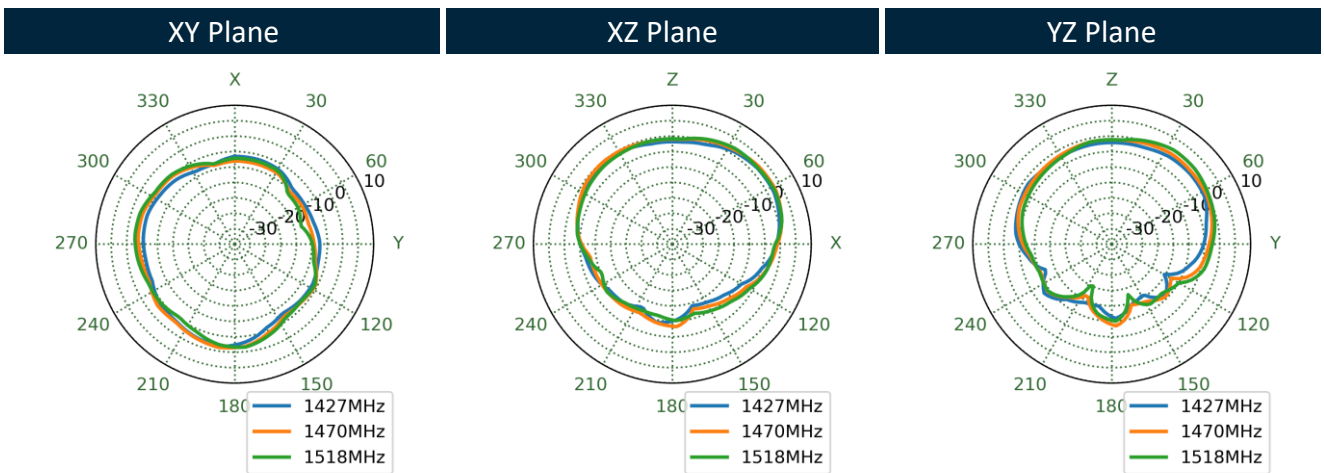
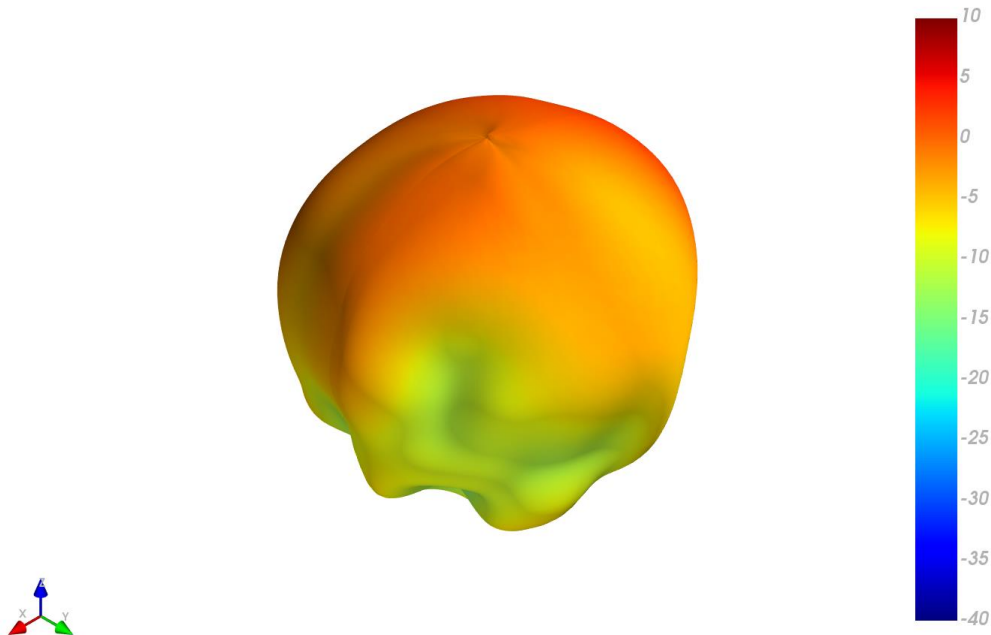

1805MHz

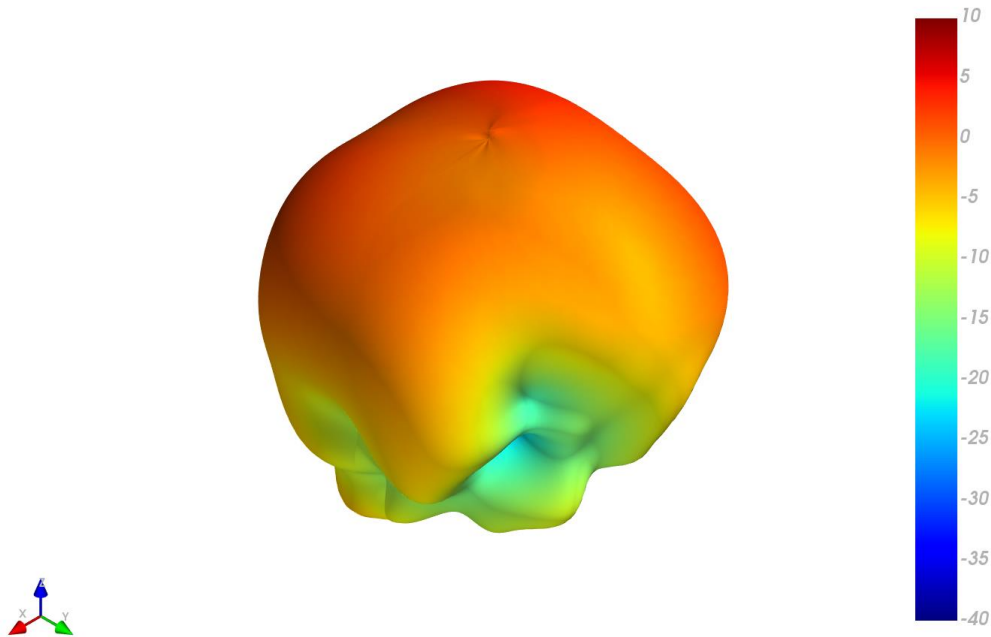

XY Plane XZ Plane YZ Plane

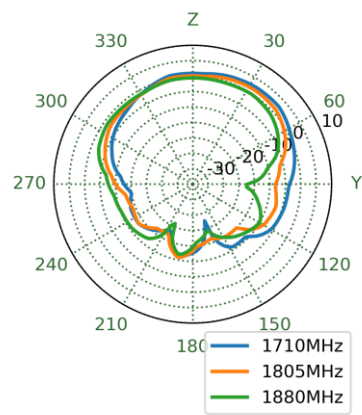
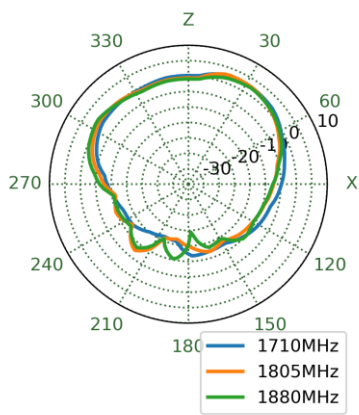
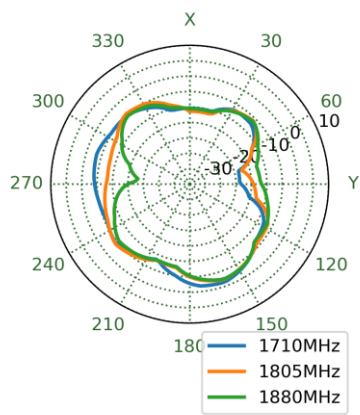

1920MHz

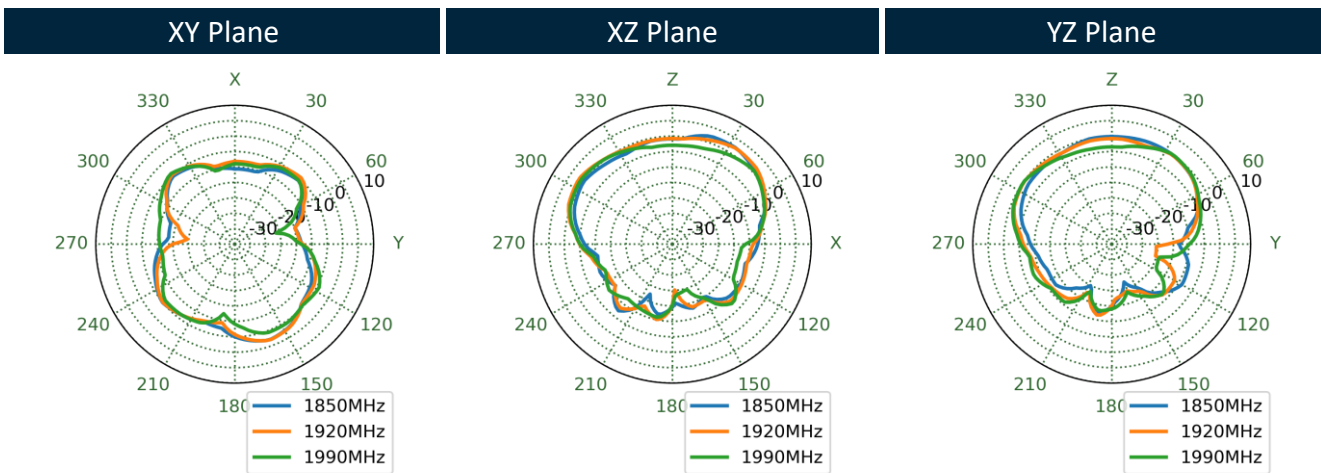
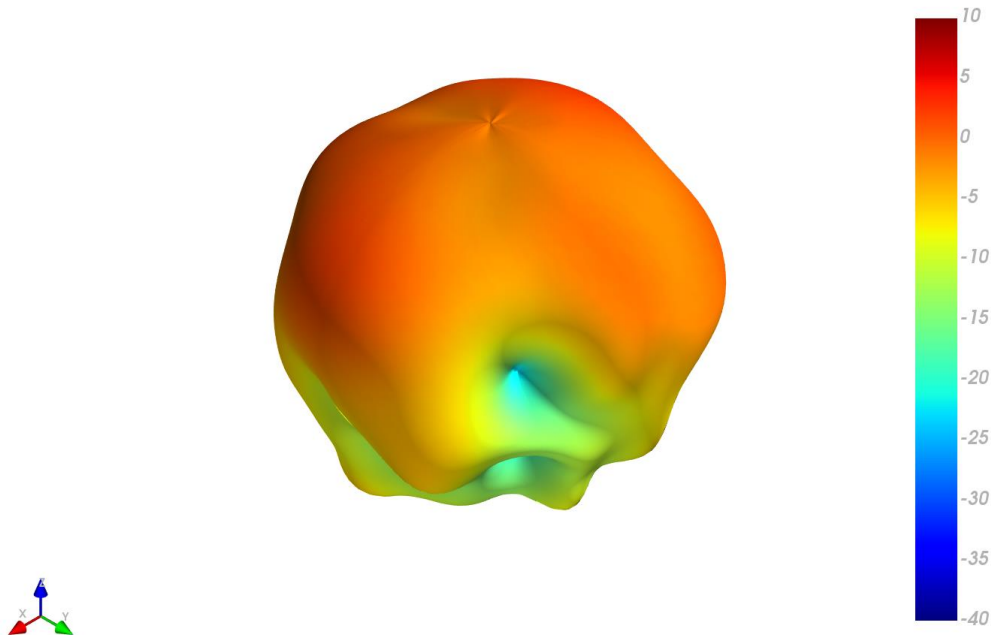

1990MHz

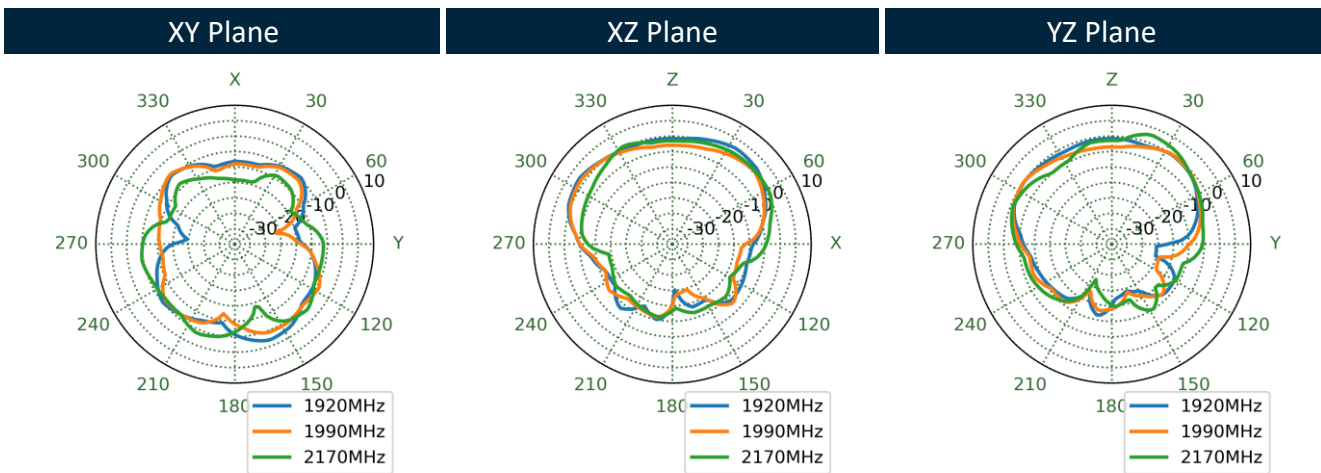
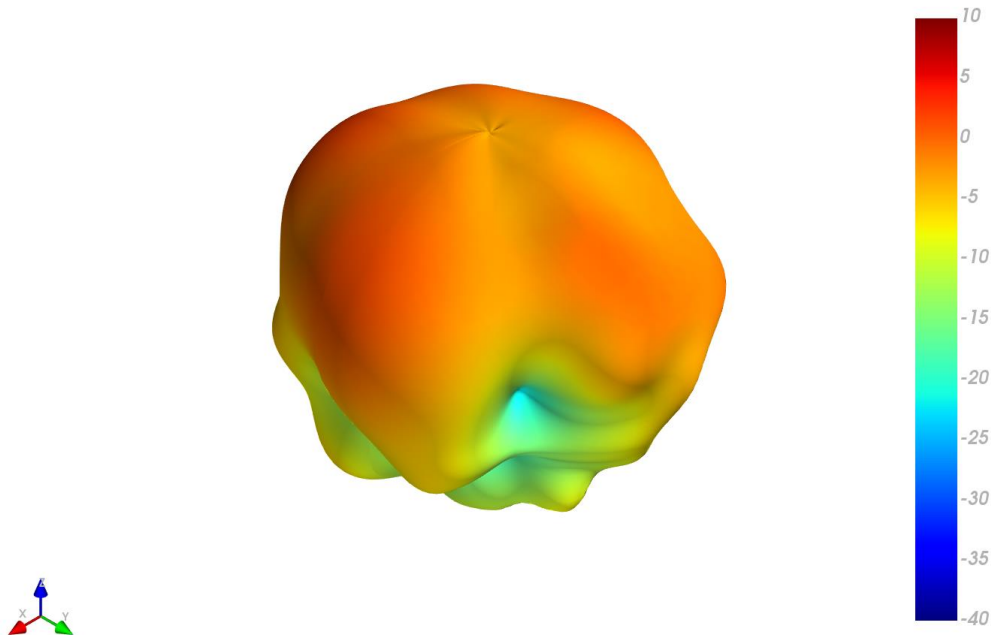

2595MHz

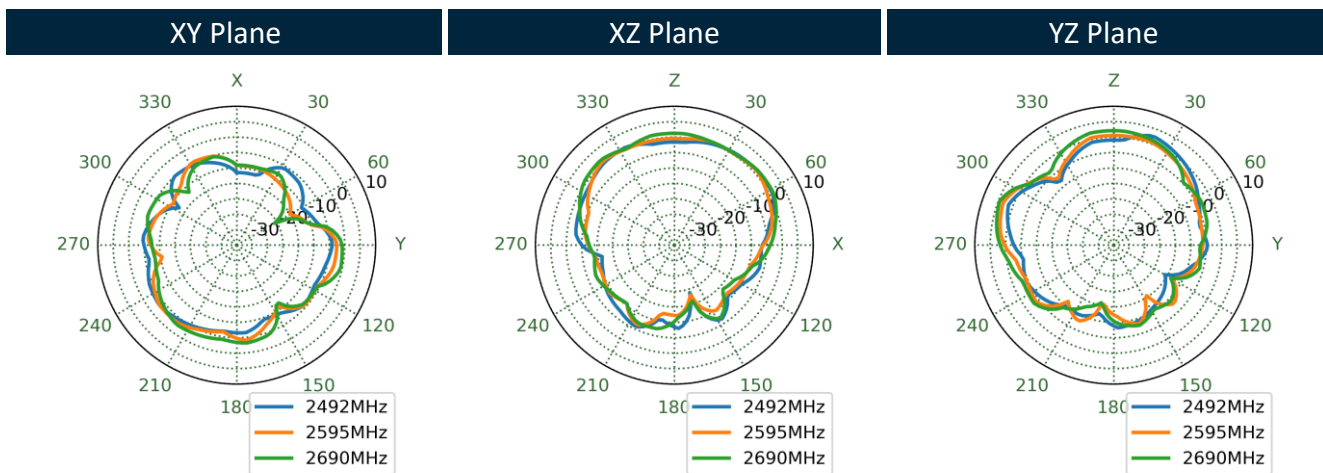
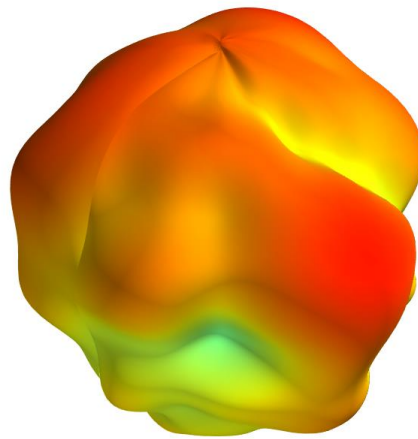

3550MHz

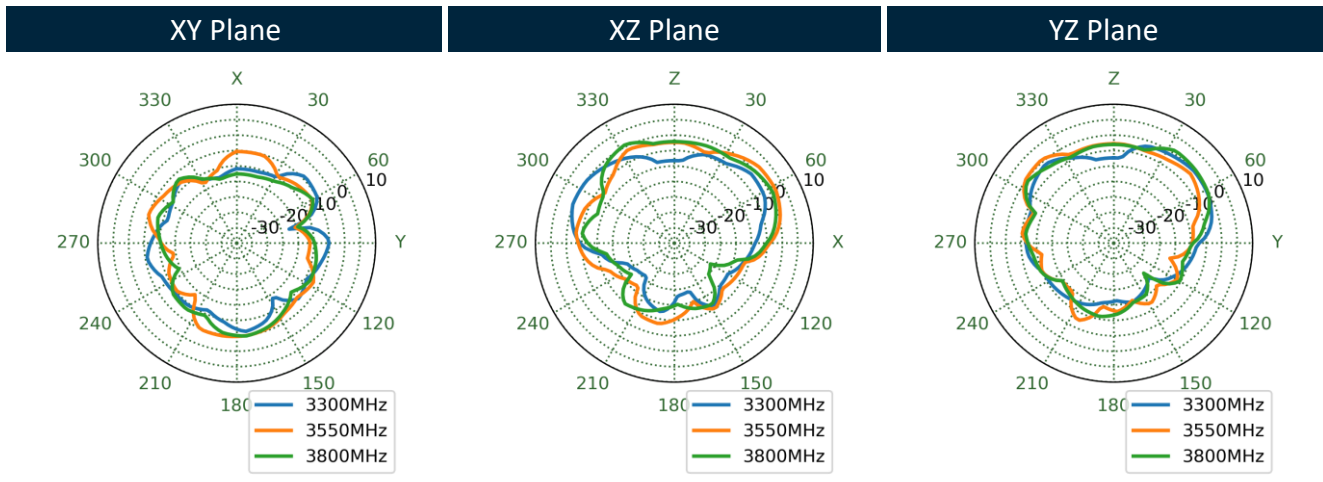
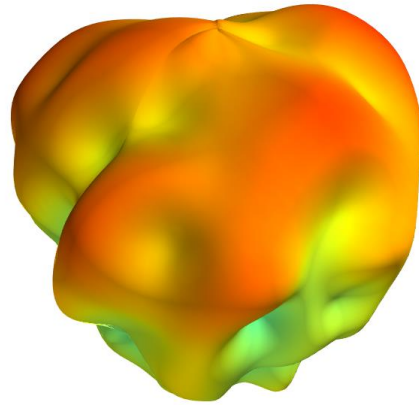

5530MHz

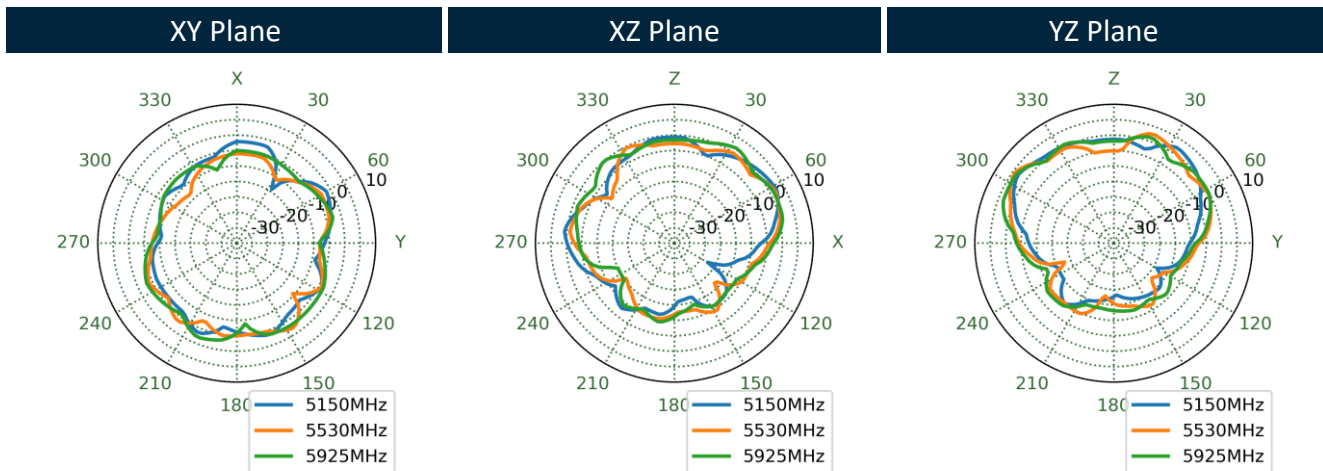
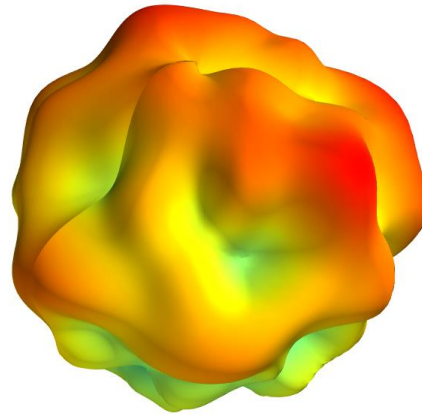

5.5 5G/4G MIMO 4 Radiation Pattern

652MHz

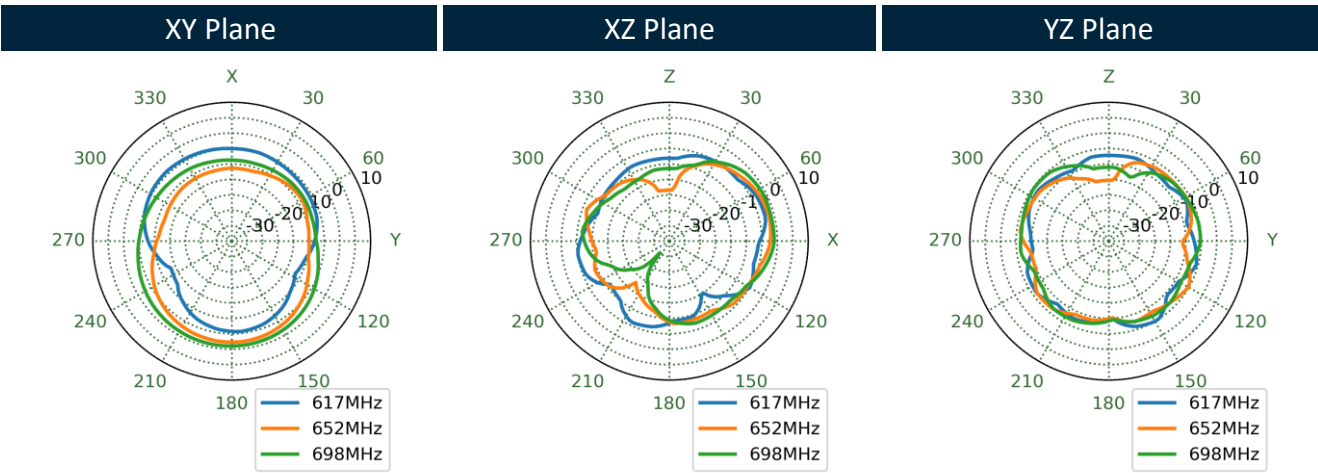
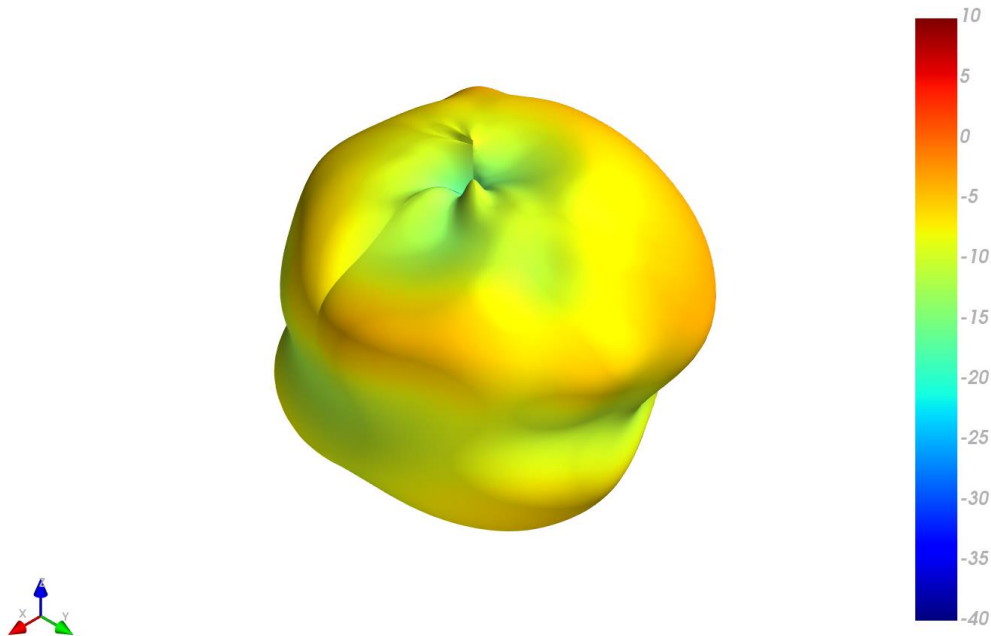

751MHz

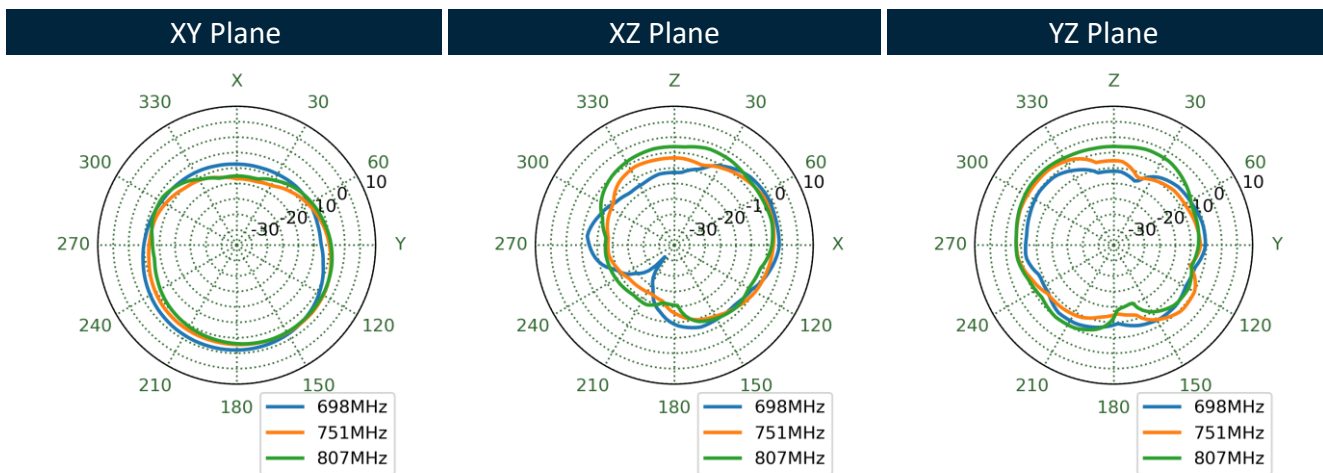
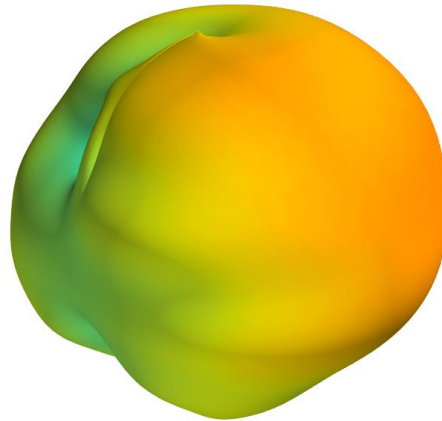

890MHz

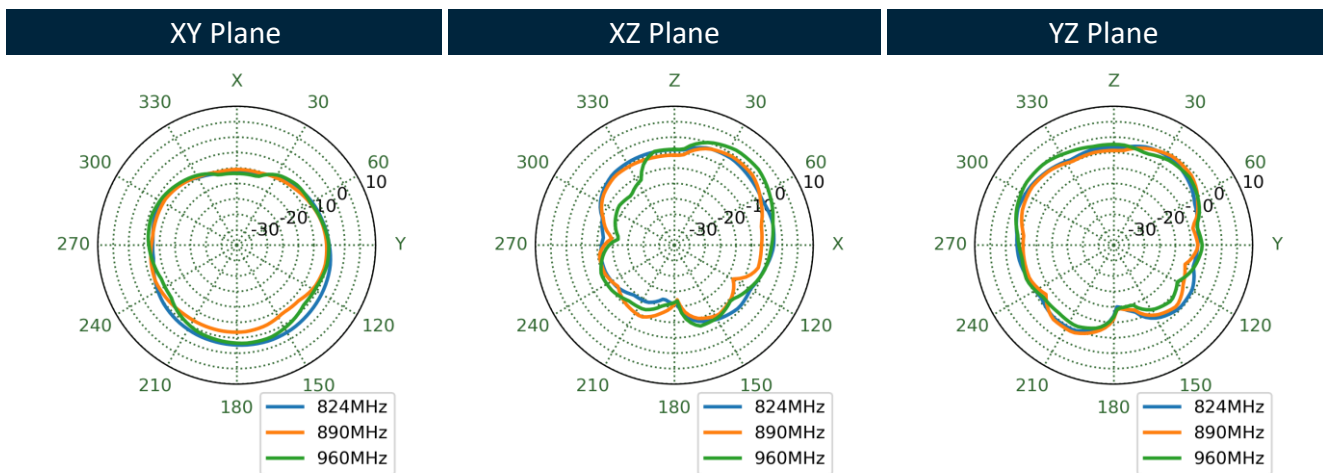
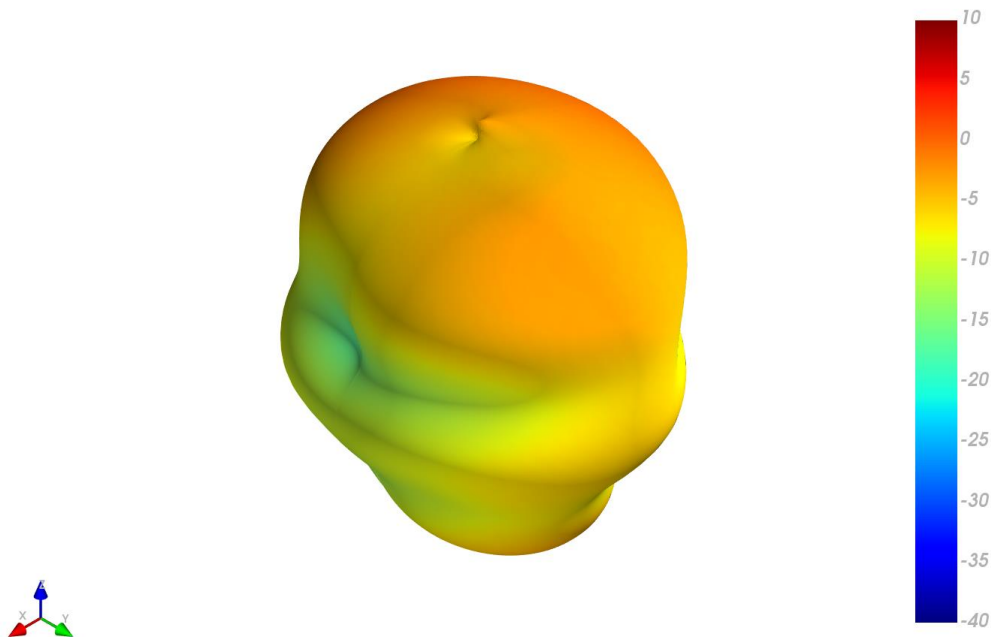

1470MHz

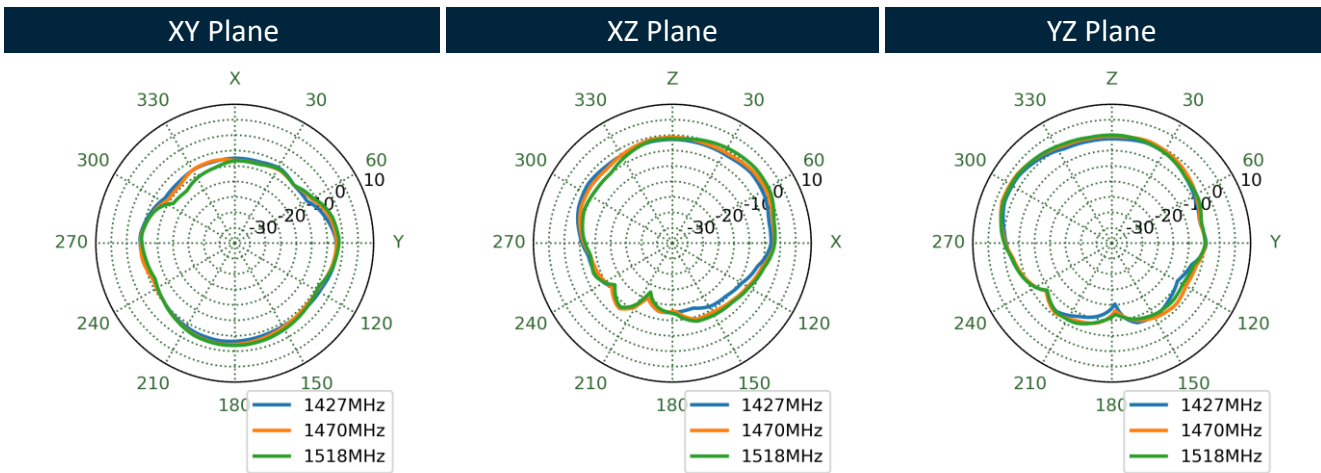
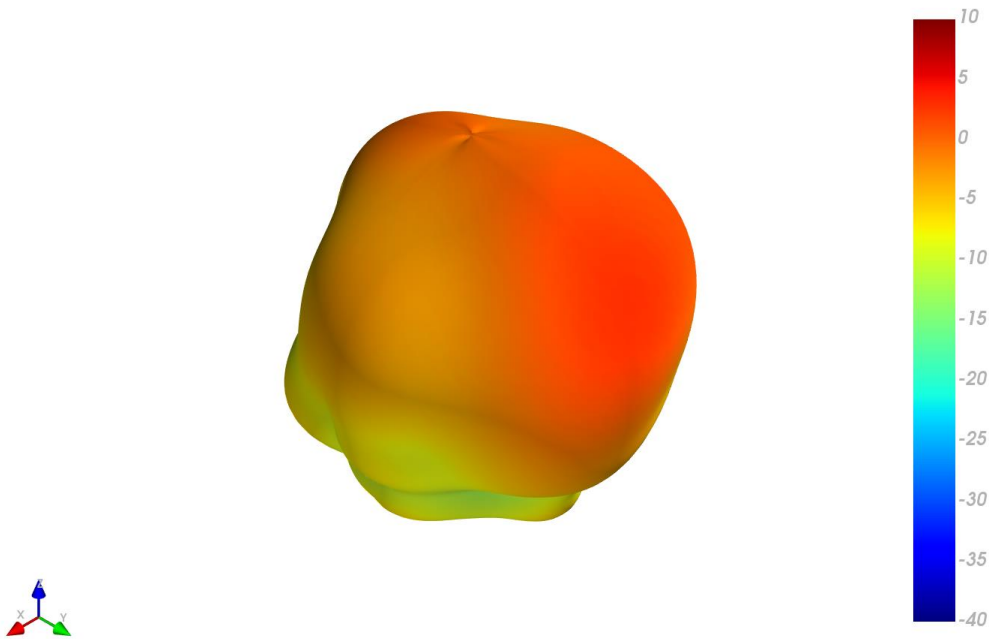

1805MHz

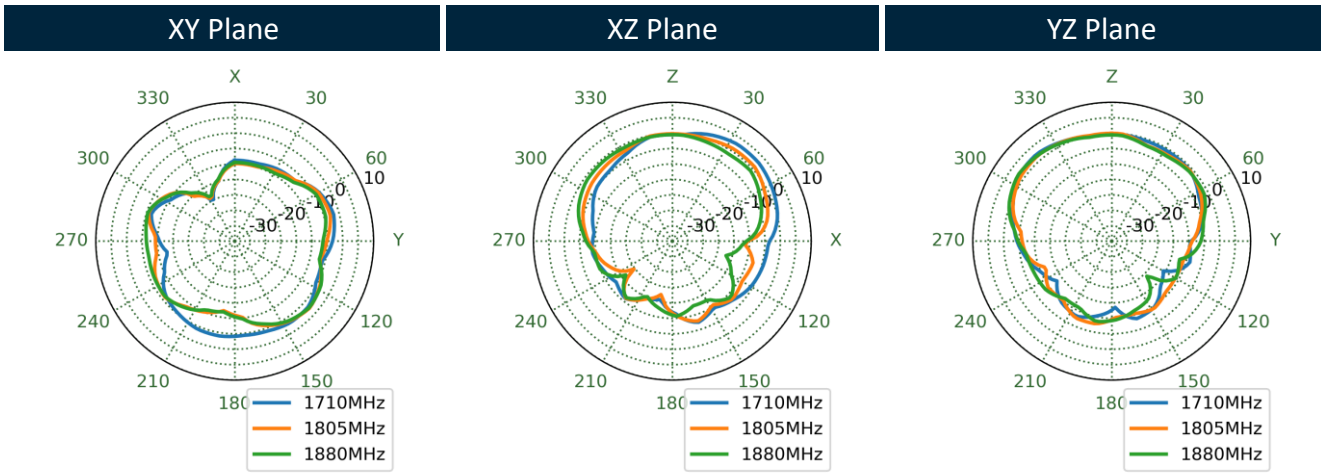
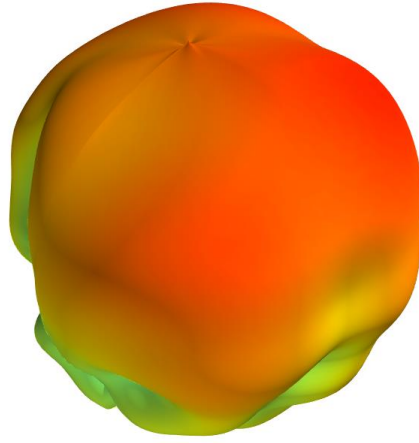

1920MHz

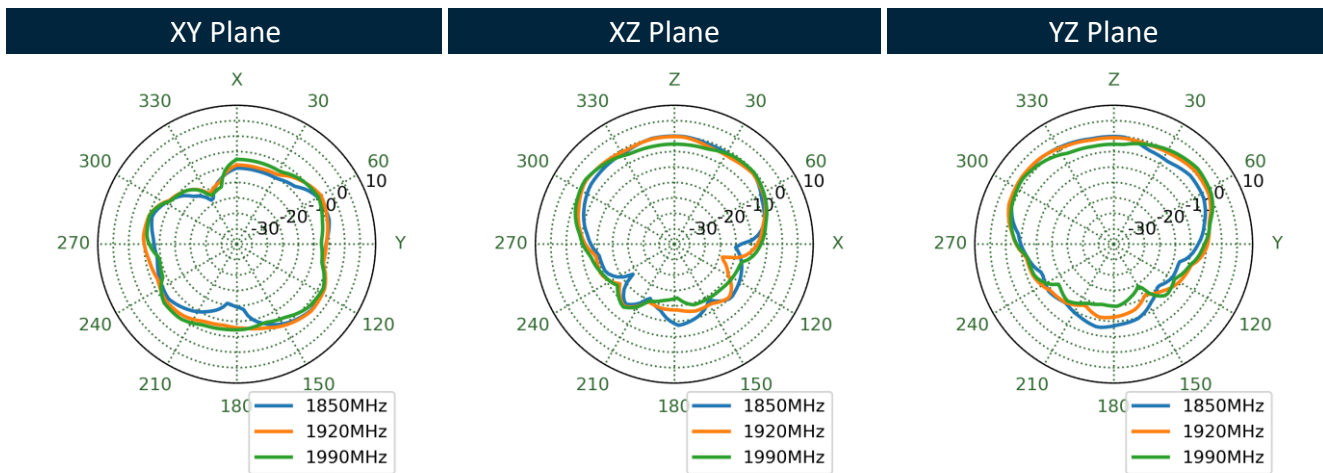
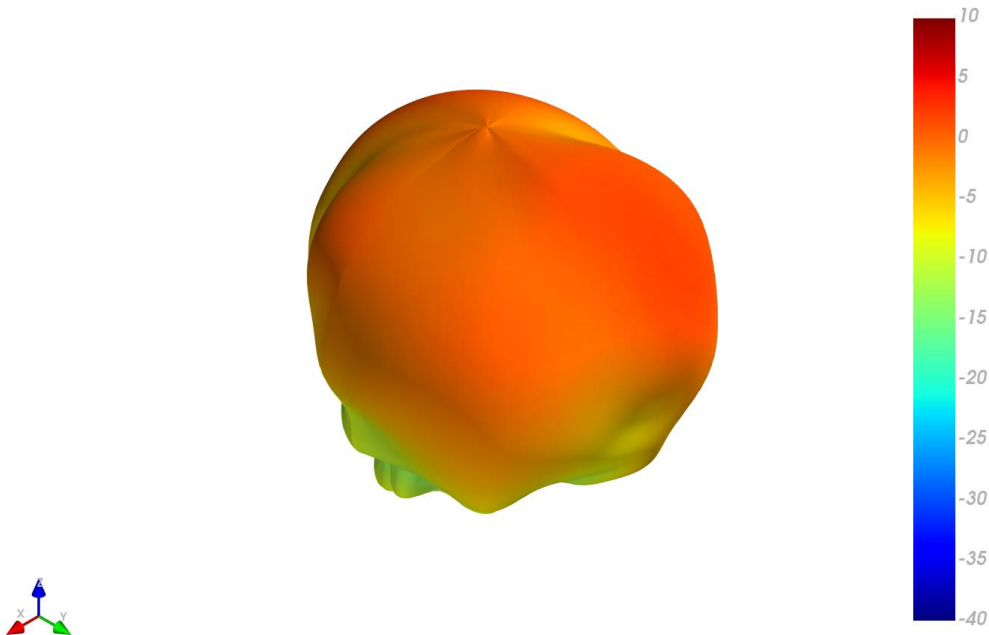

1990MHz

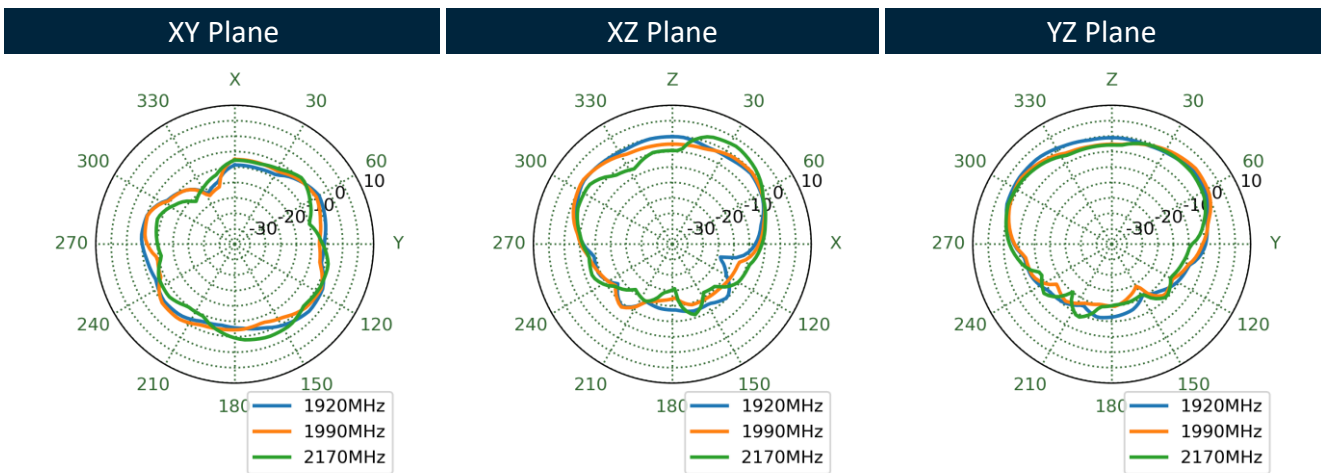
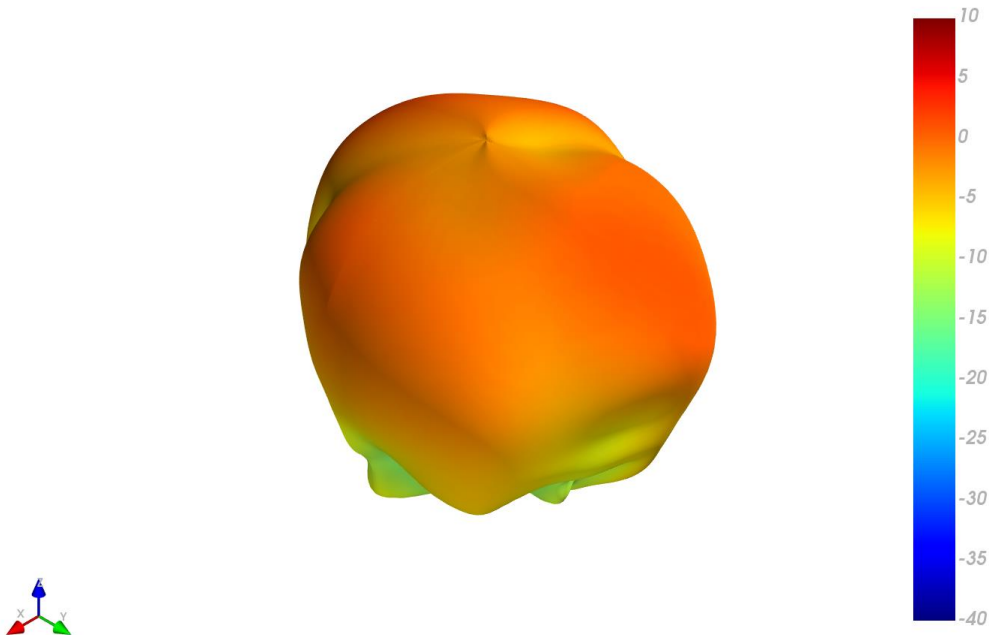

2595MHz

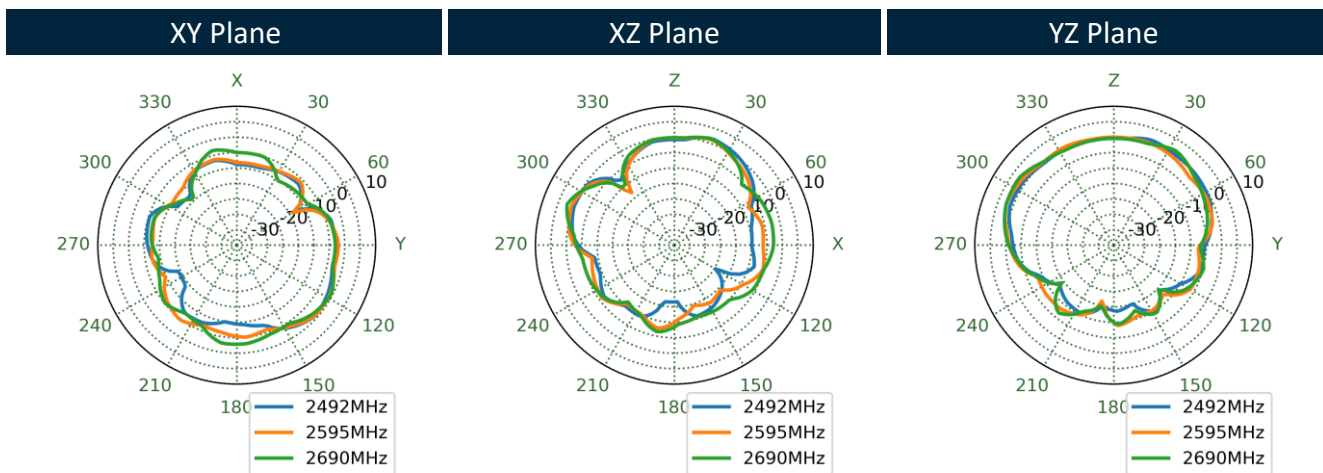
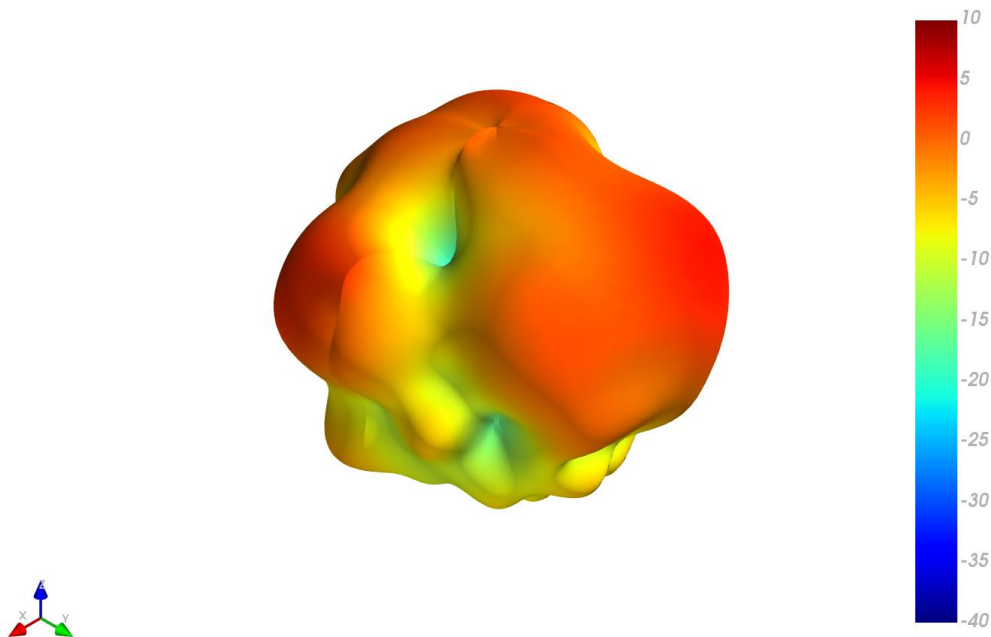

3550MHz

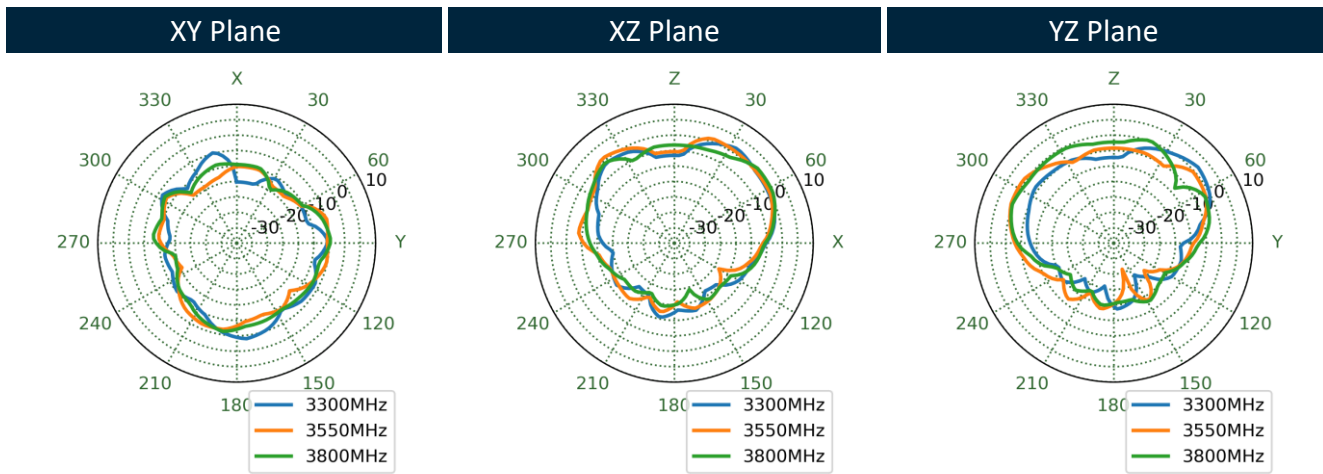
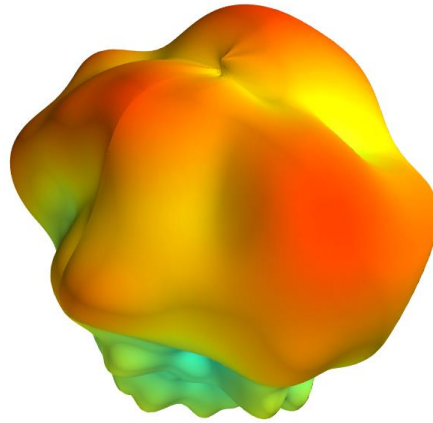

5530MHz

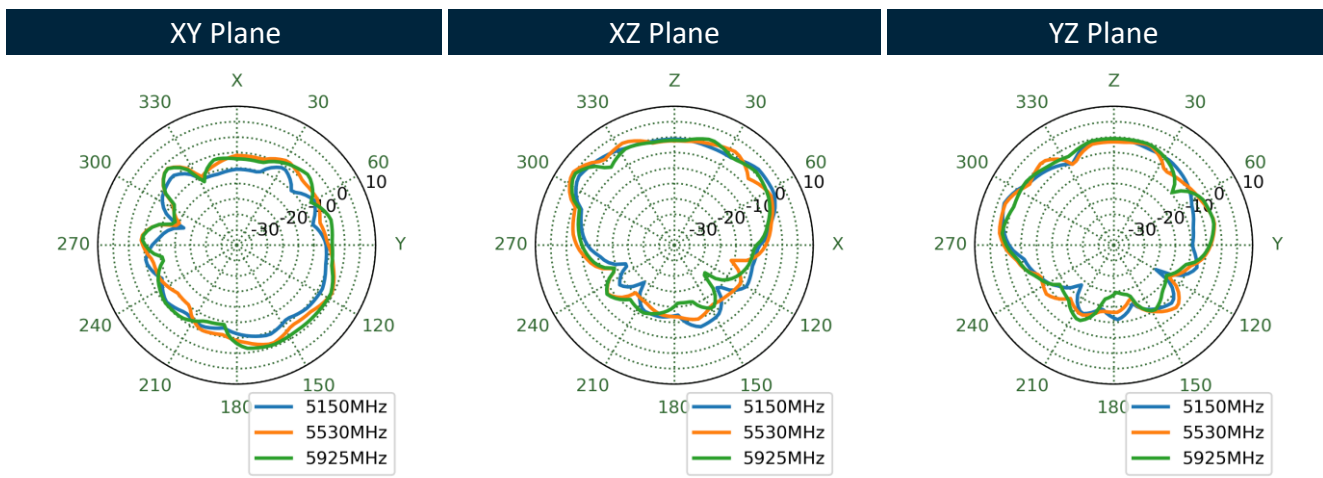
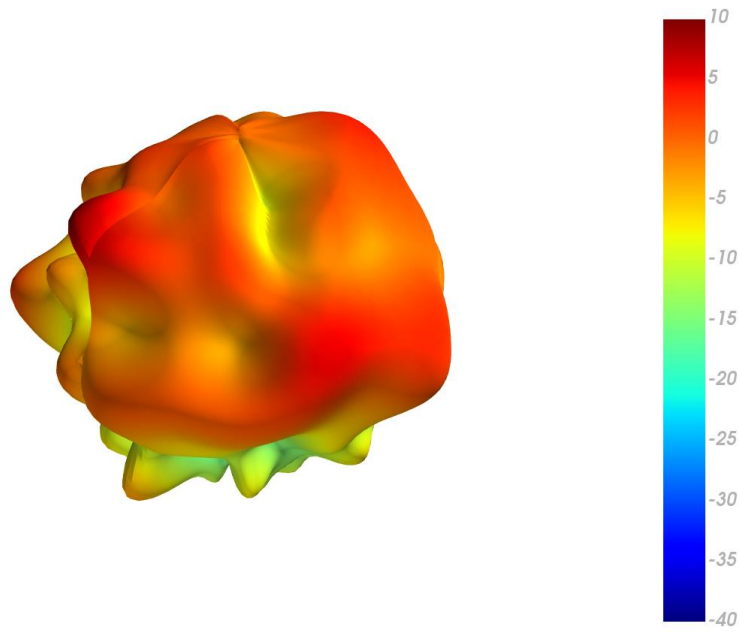

5.6 5G/4G MIMO 4 Radiation Pattern

652MHz

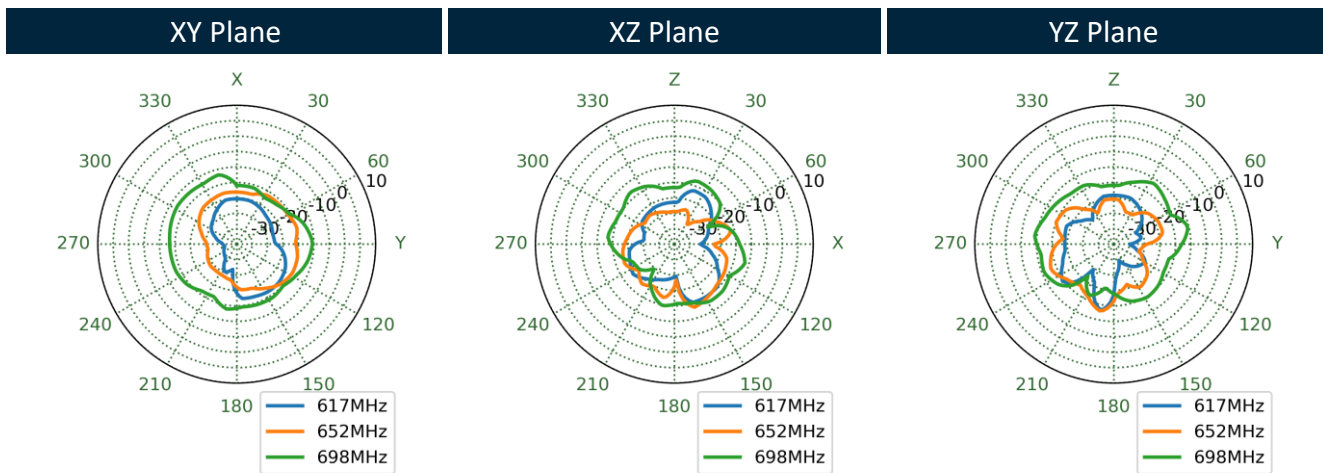
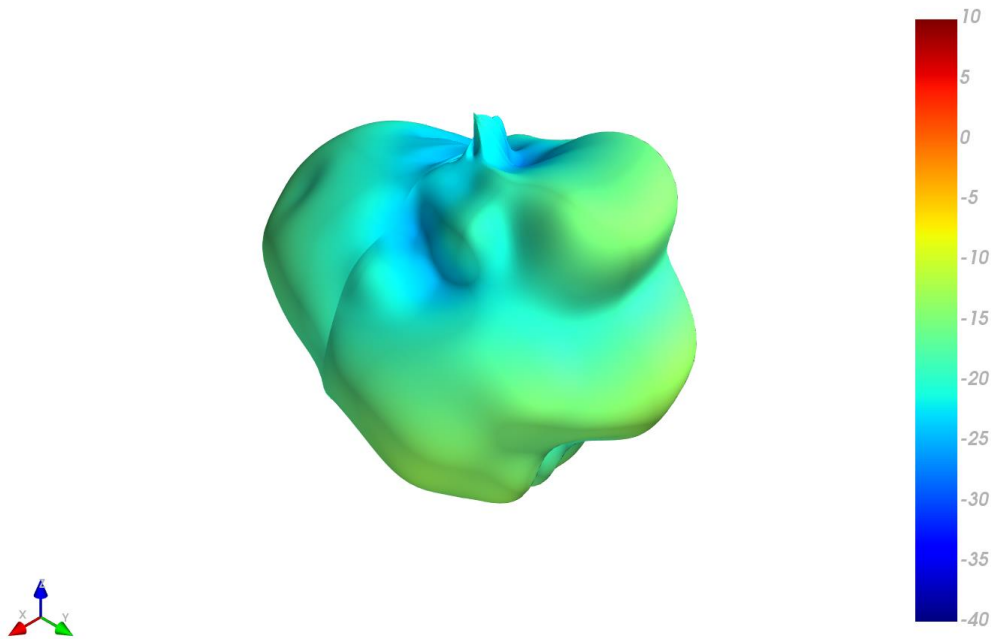

751MHz

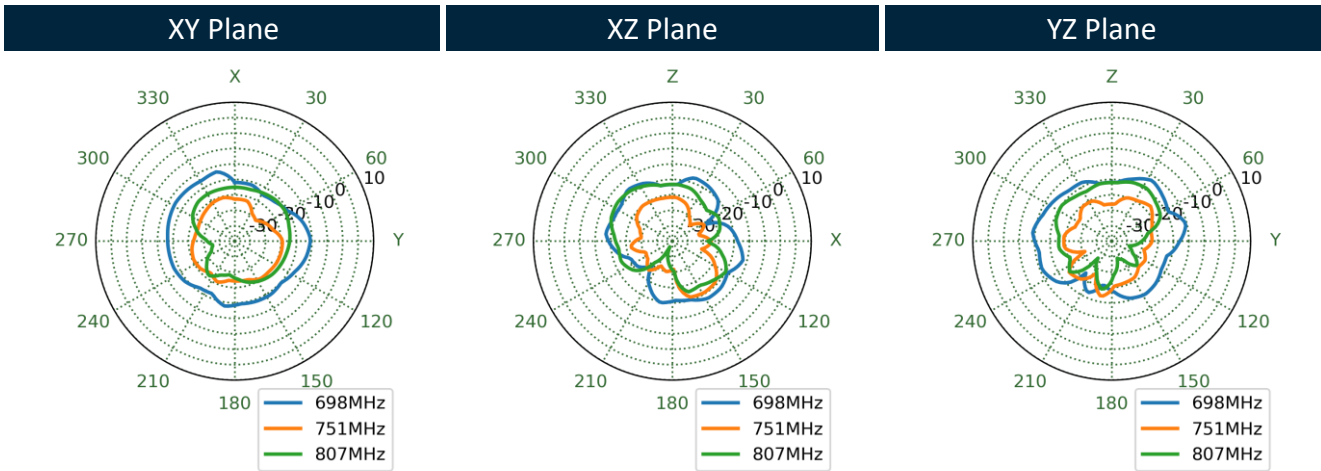
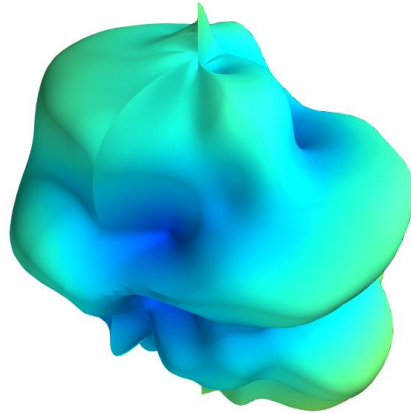

890MHz

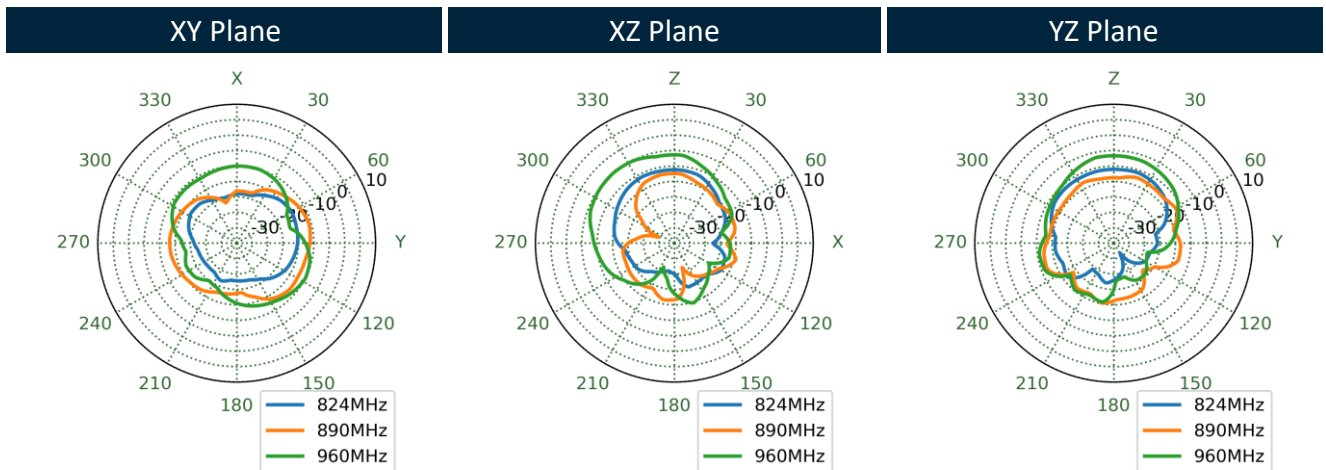
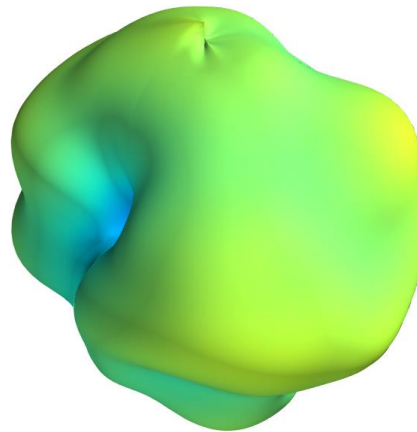

1470MHz

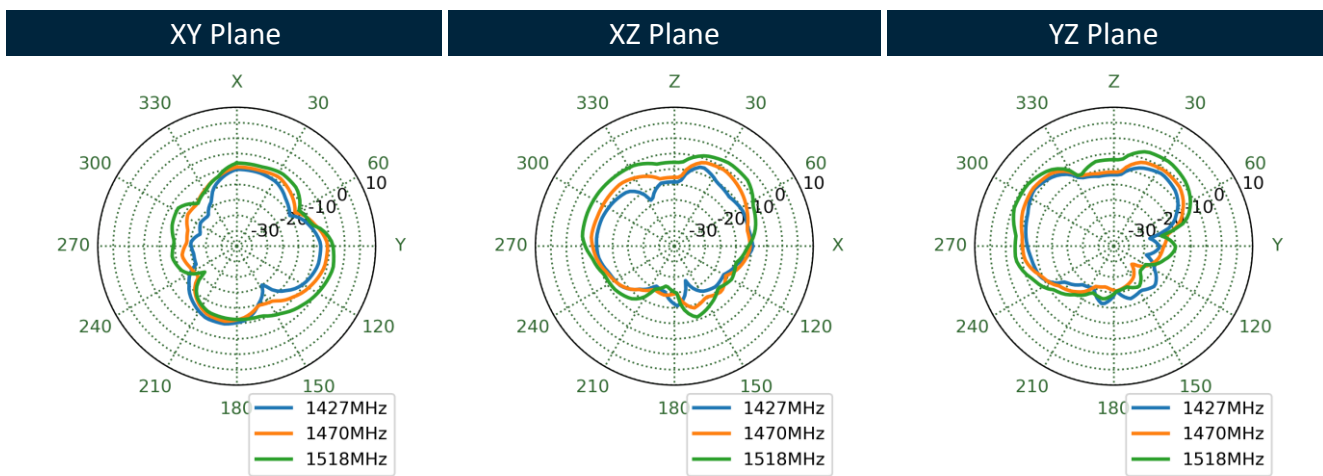
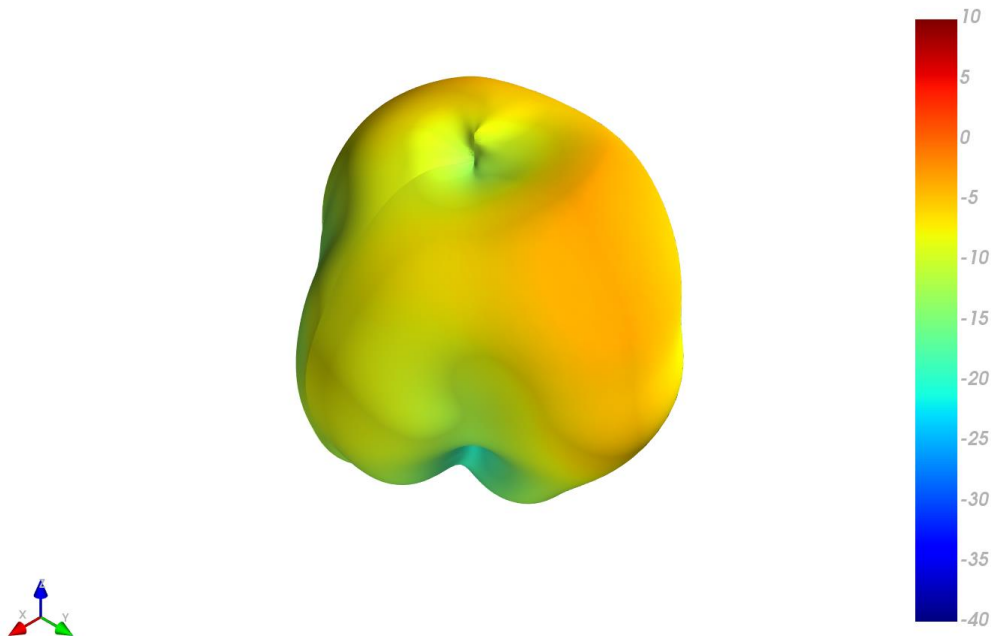

1805MHz

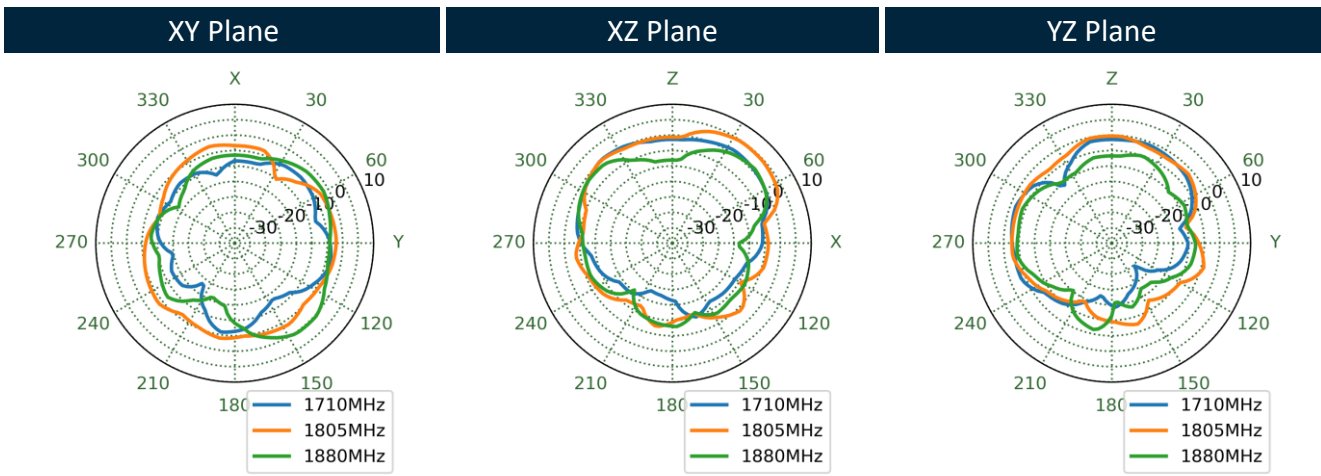
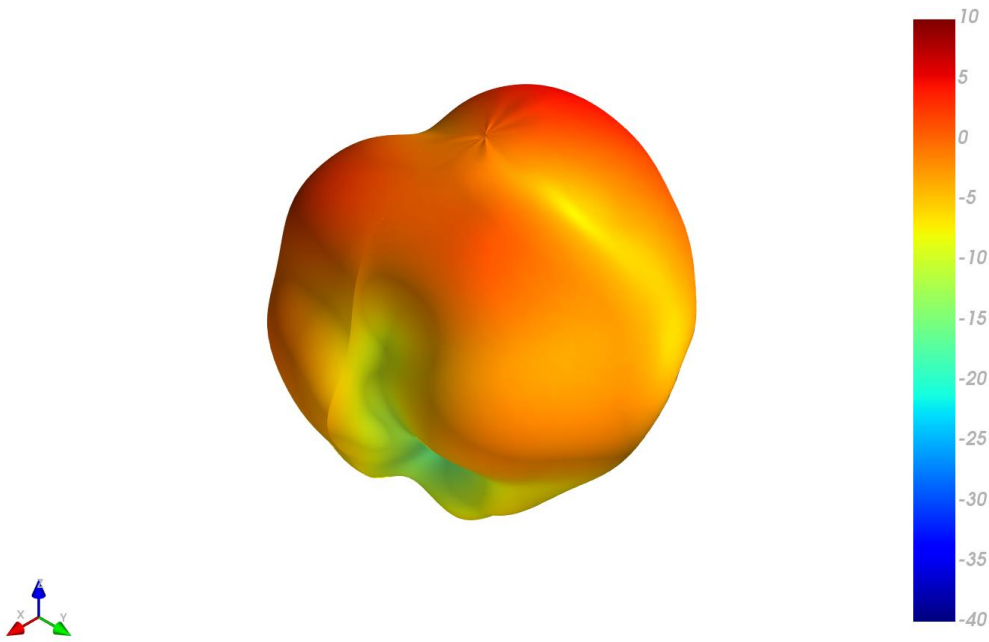

1920MHz

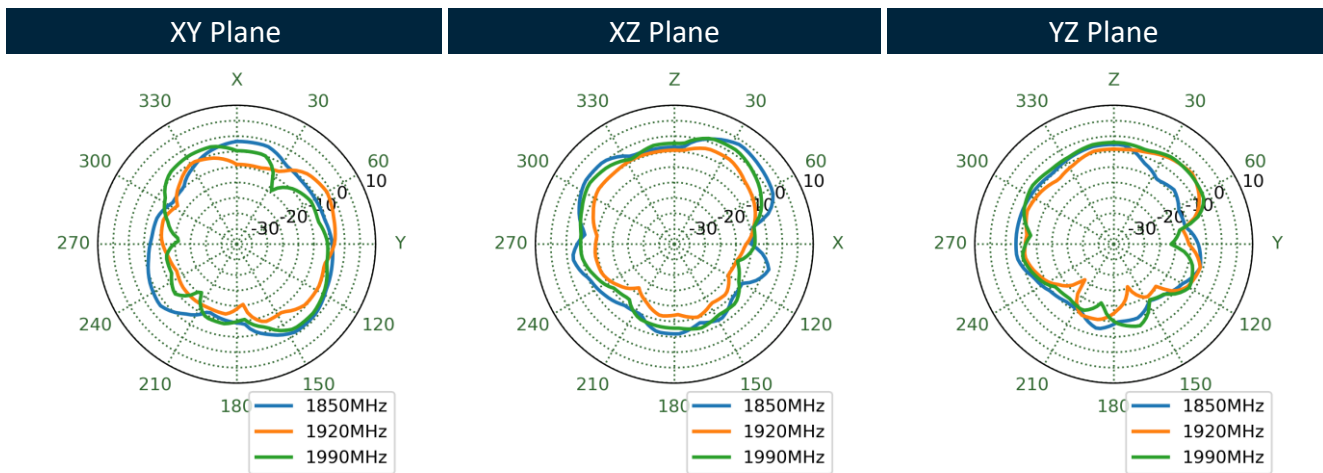
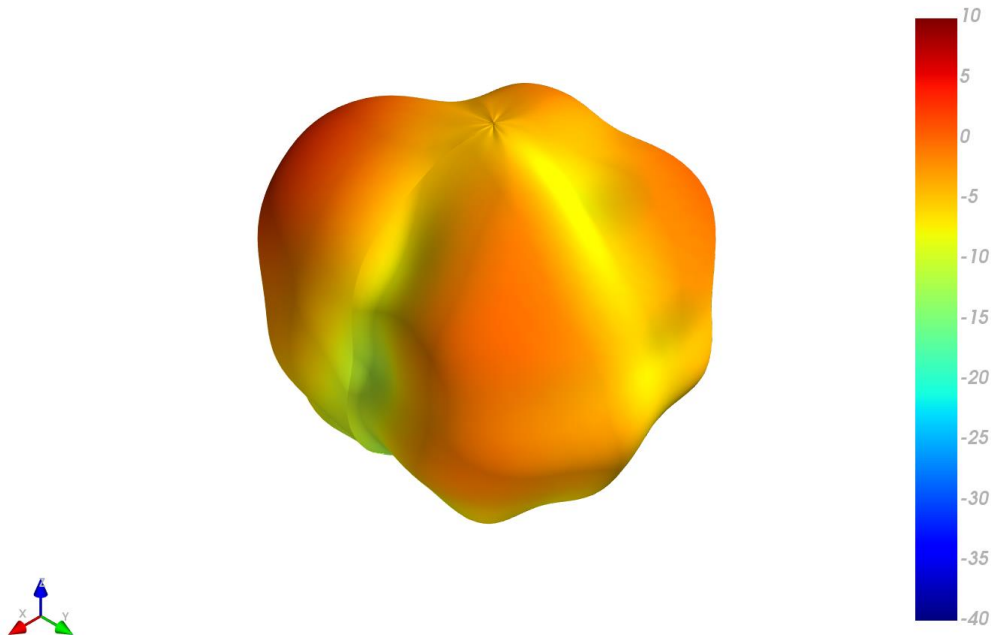

1990MHz

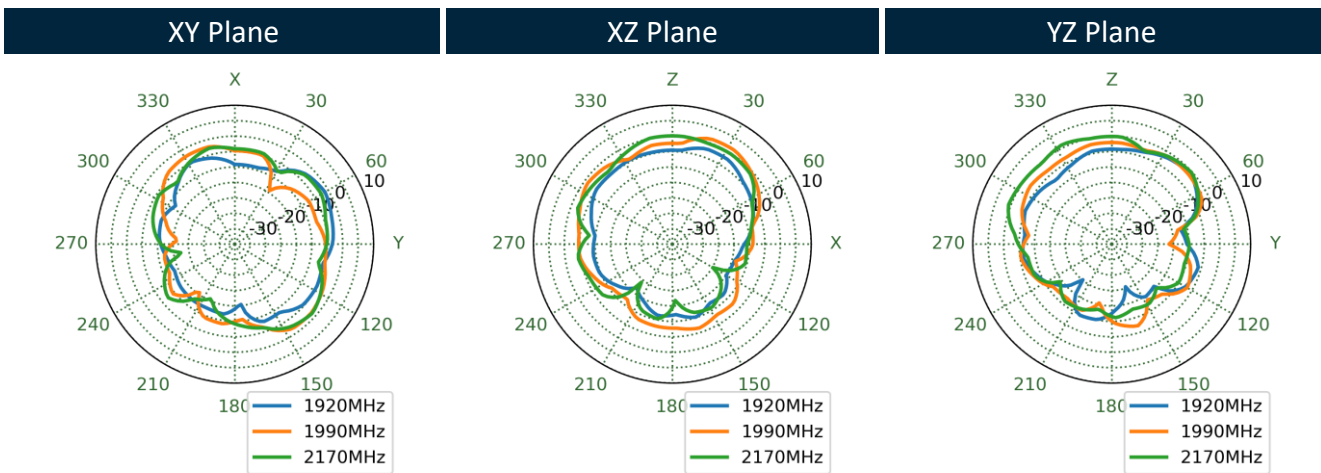
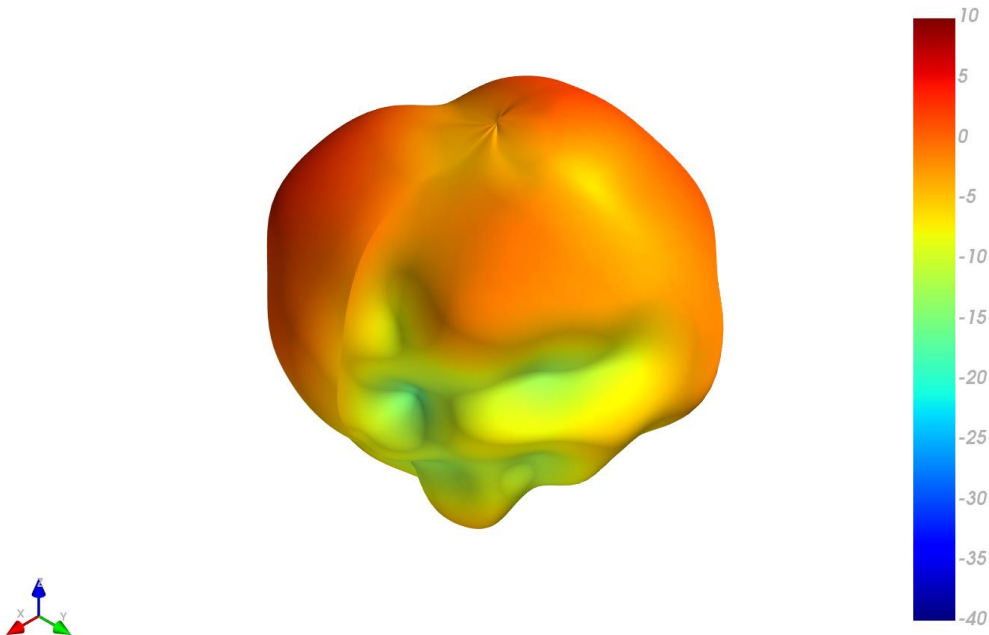

2595MHz

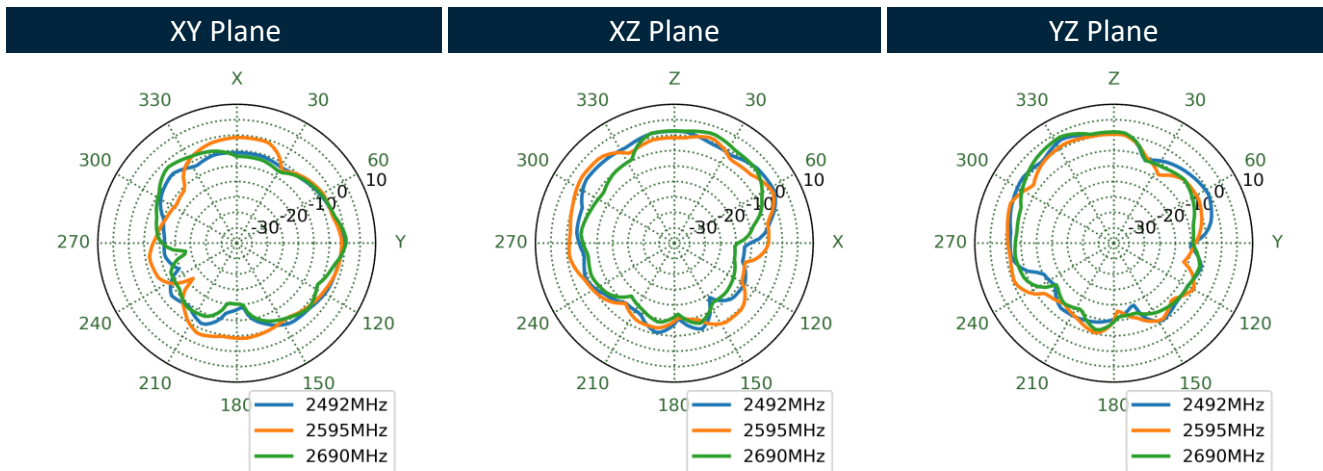
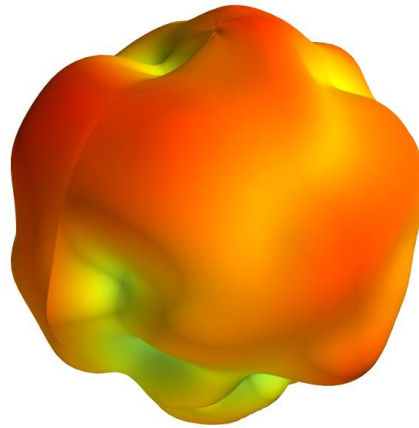

3550MHz

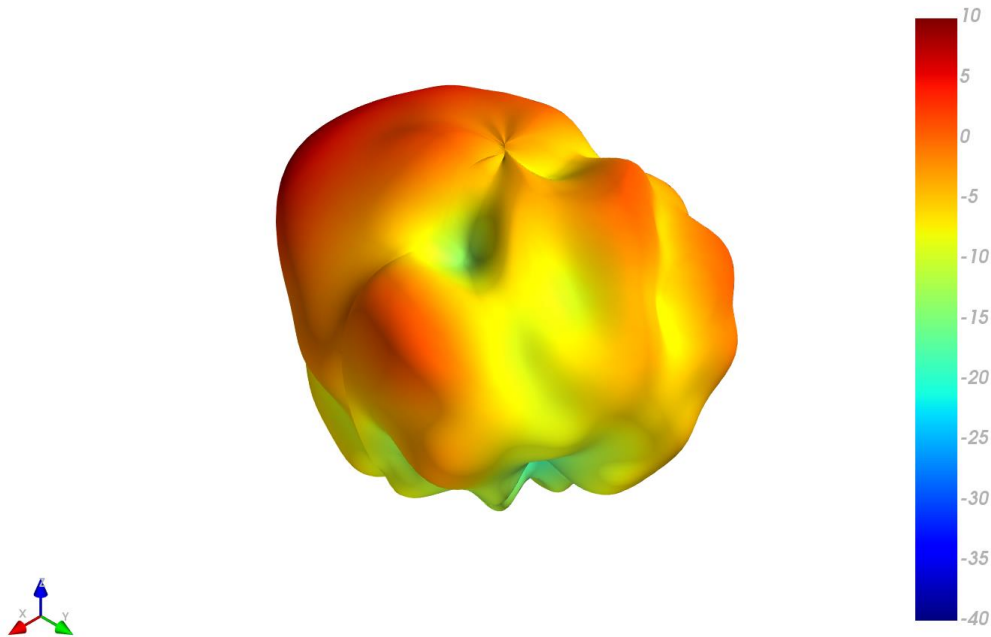

XY Plane XZ Plane YZ Plane

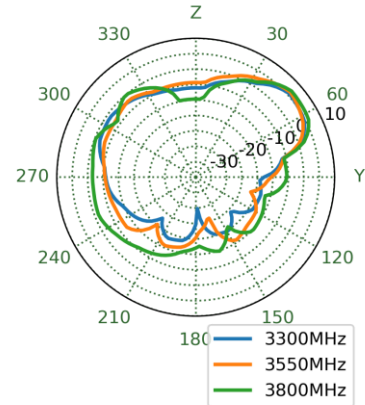
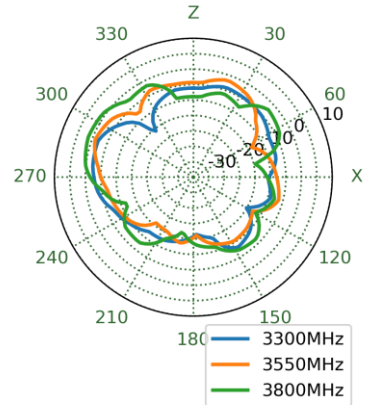
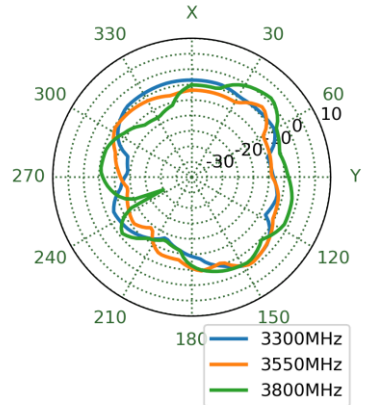

5530MHz

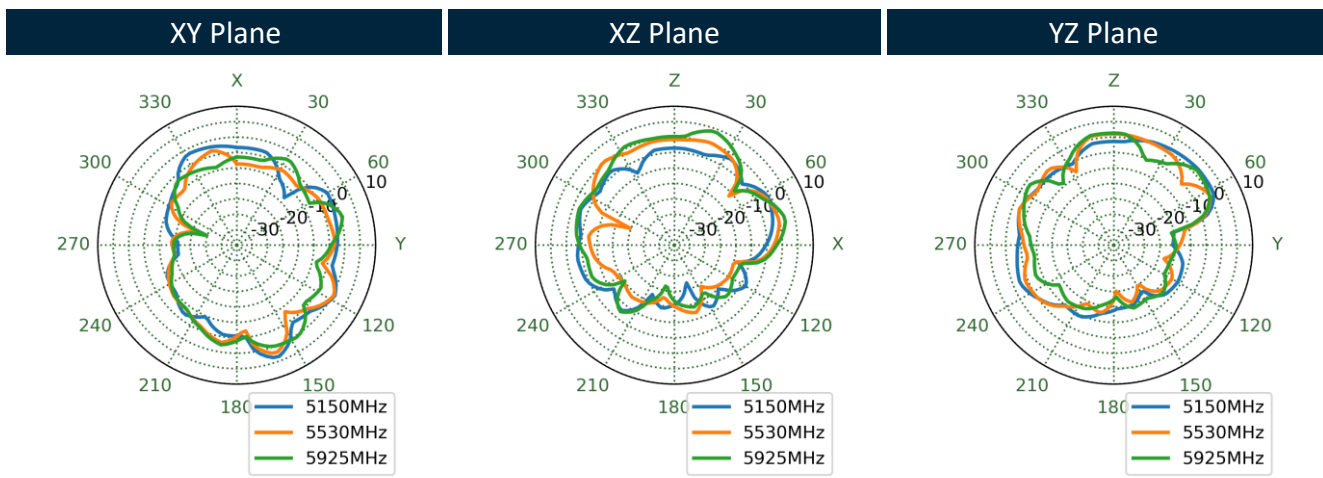
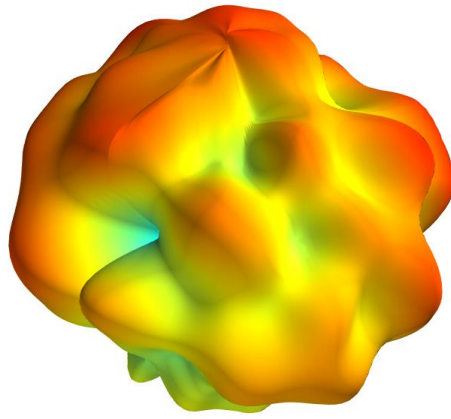

5.7 Wi-Fi MIMO 1 Radiation Pattern

2450MHz

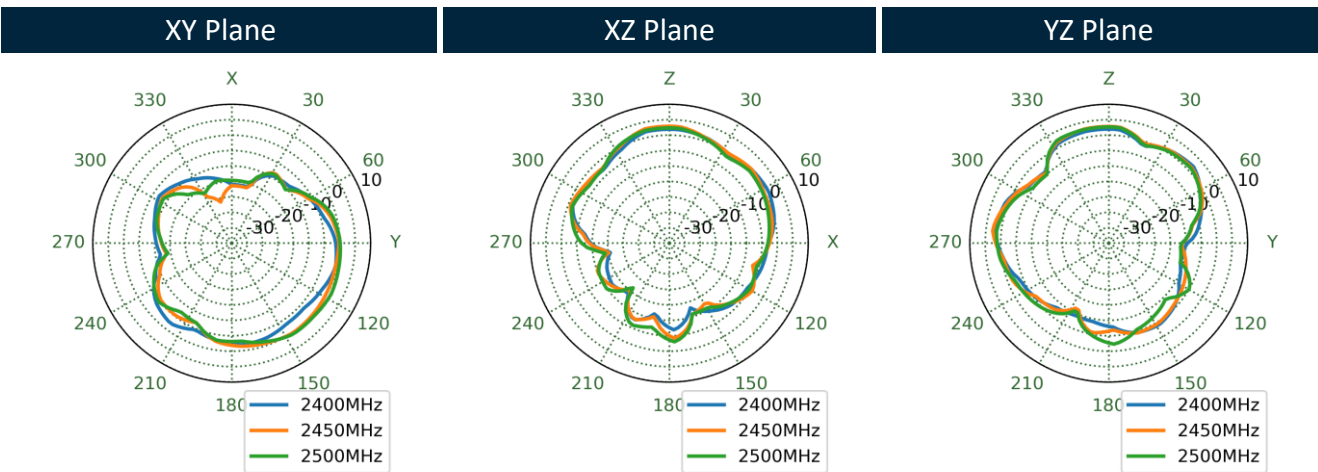
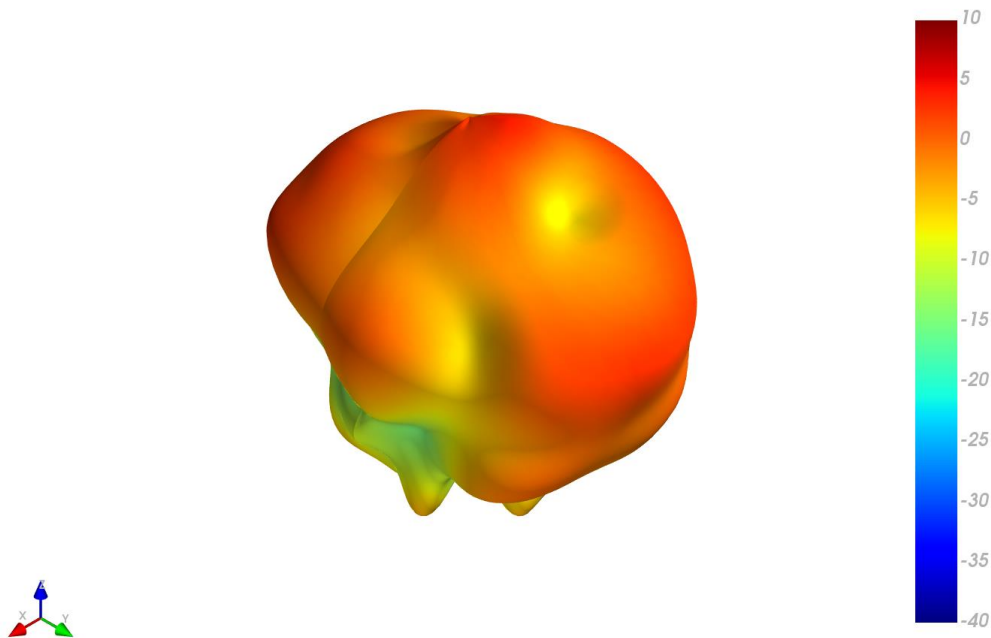

5550MHz

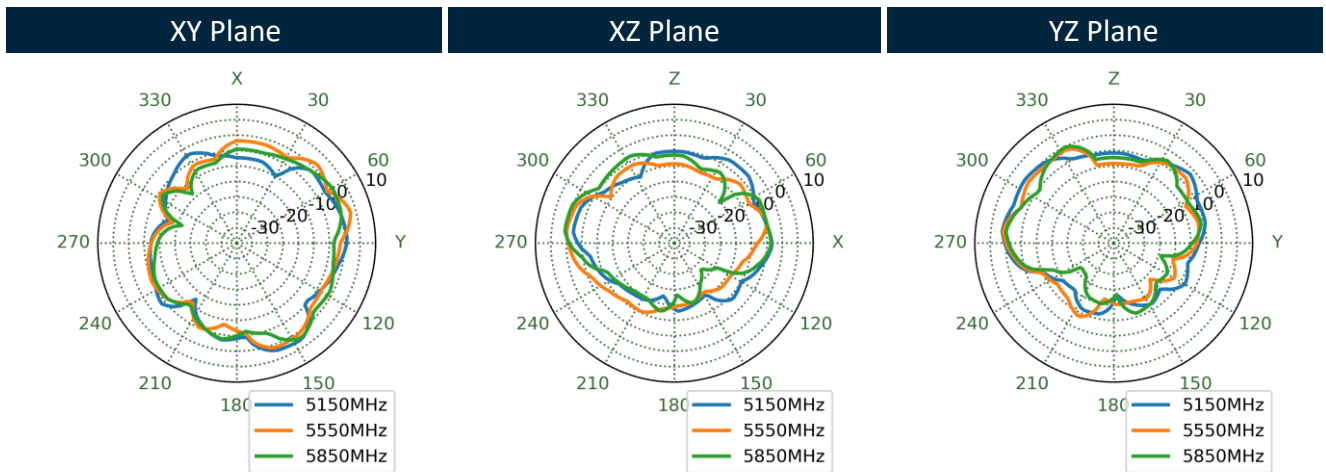
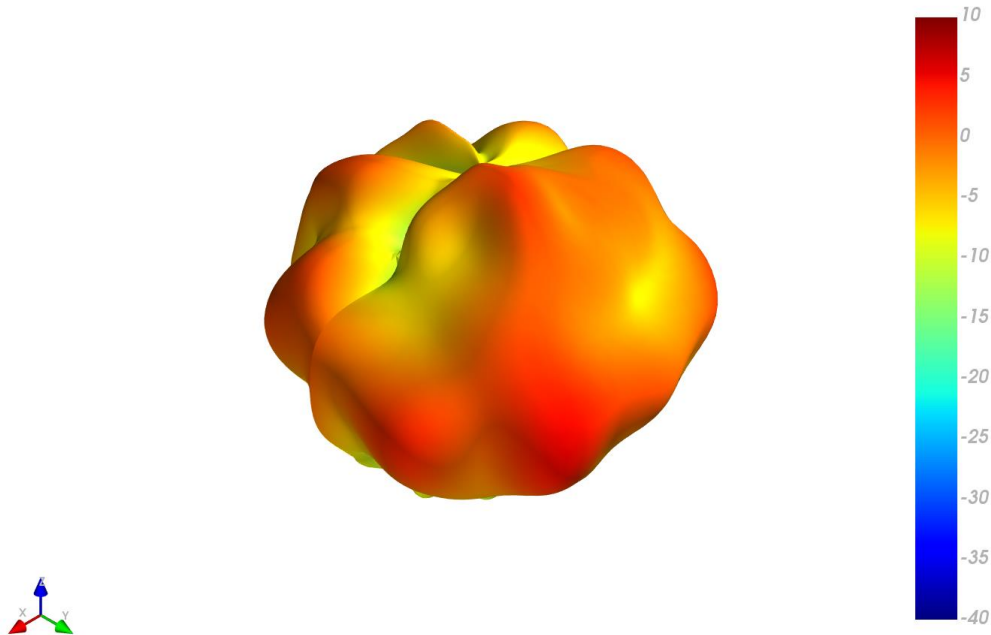

5.8 Wi-Fi MIMO 2 Radiation Pattern

2450MHz

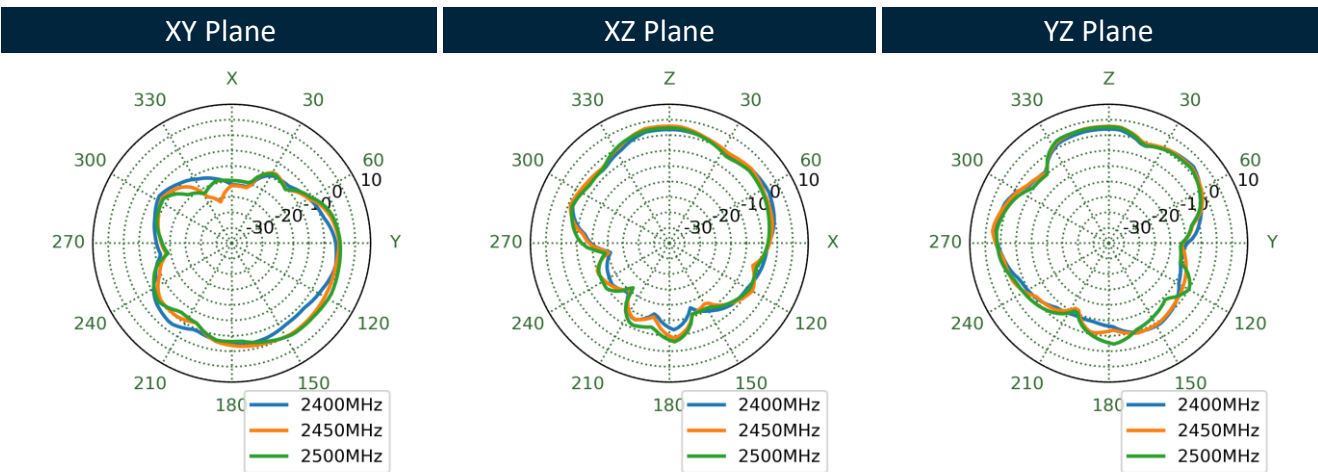
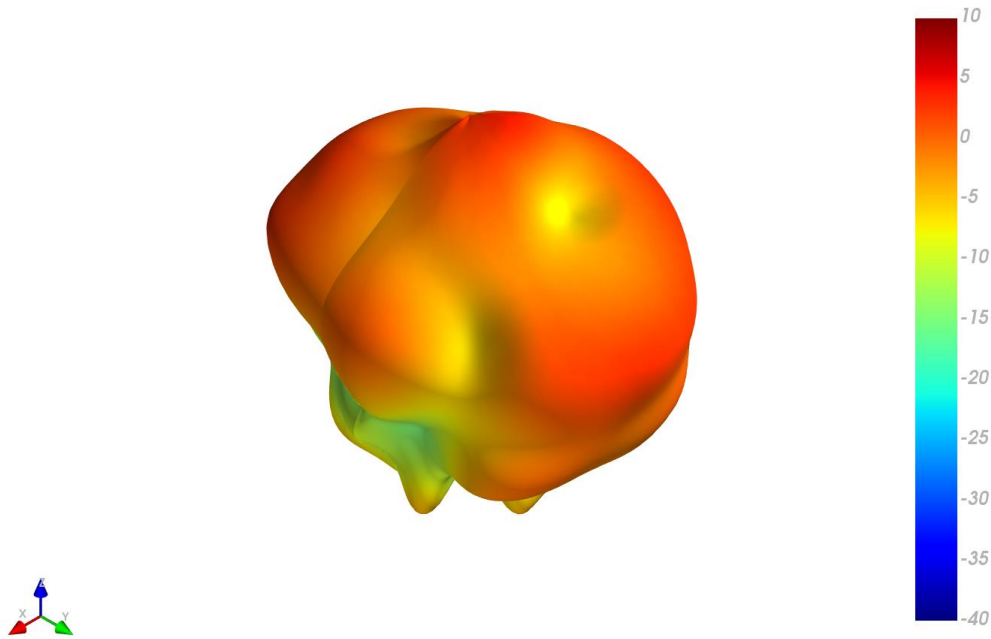

5550MHz

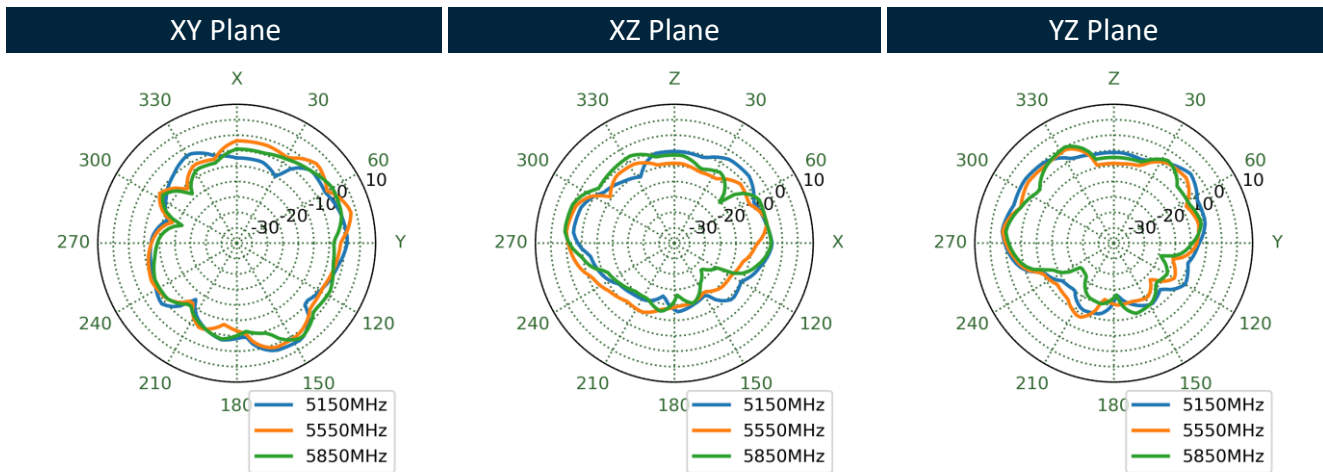
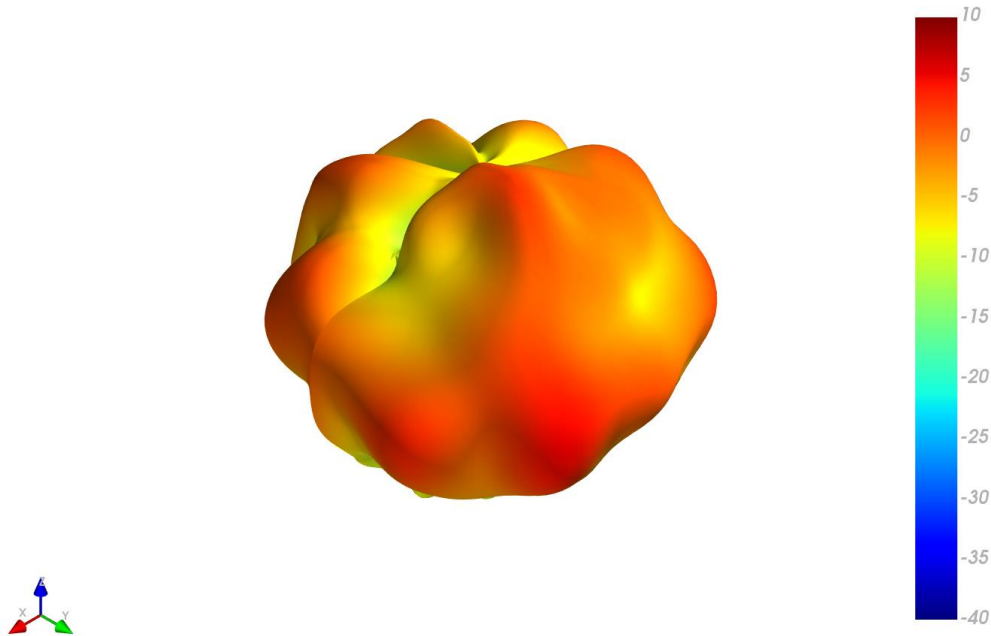

5.9 Wi-Fi MIMO 3 Radiation Pattern

2450MHz

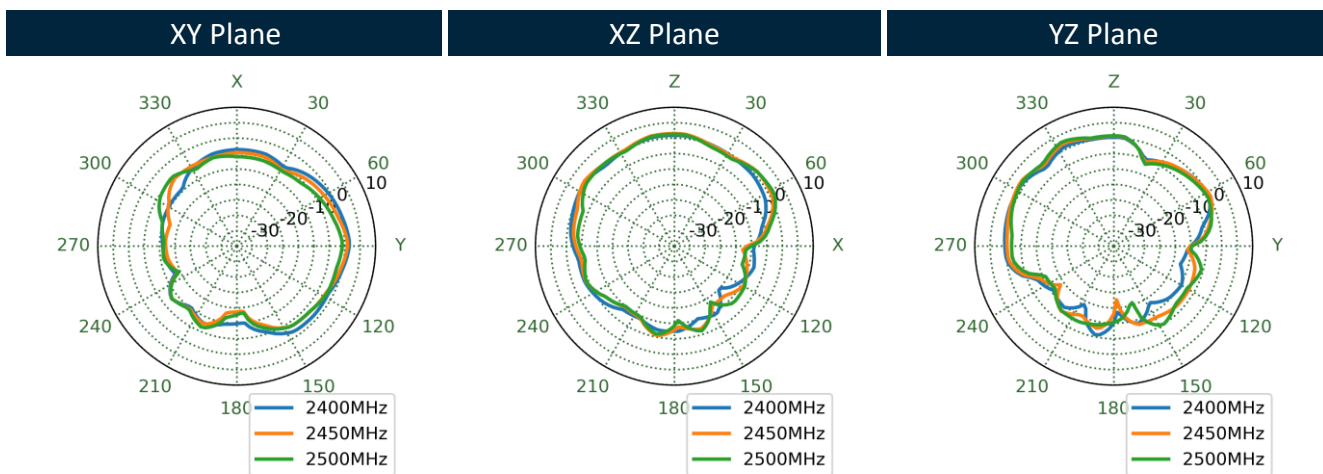
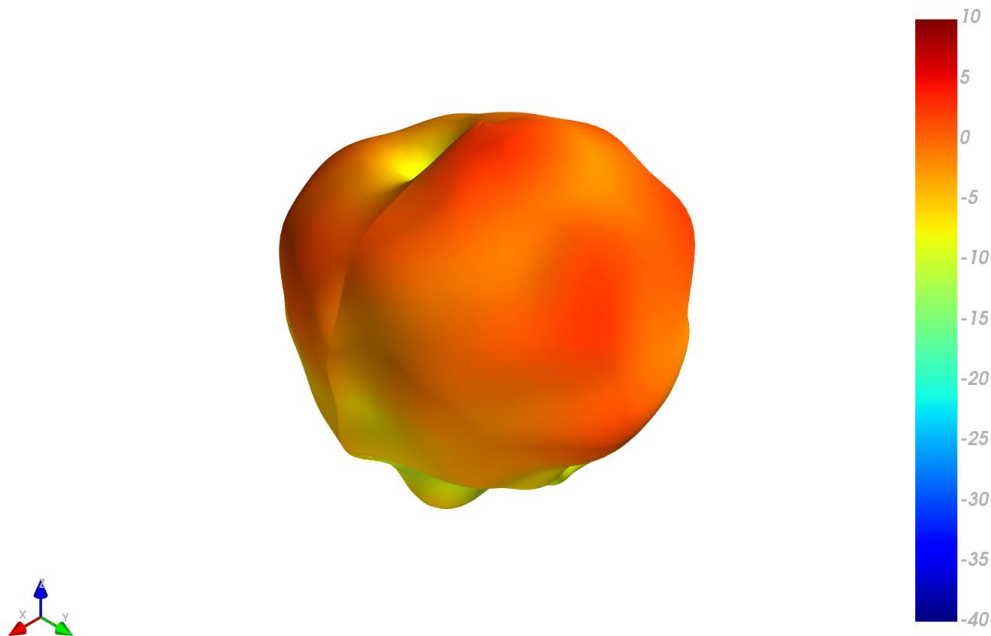

5550MHz

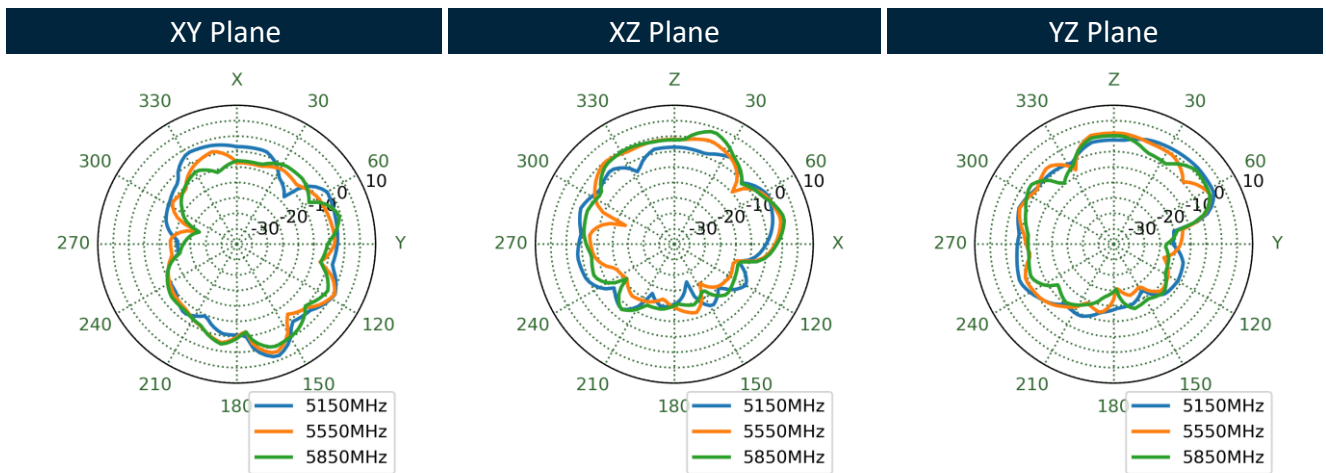
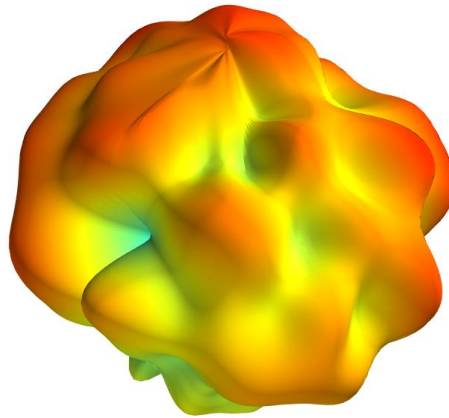

6. Mechanical Drawing (Units: mm)

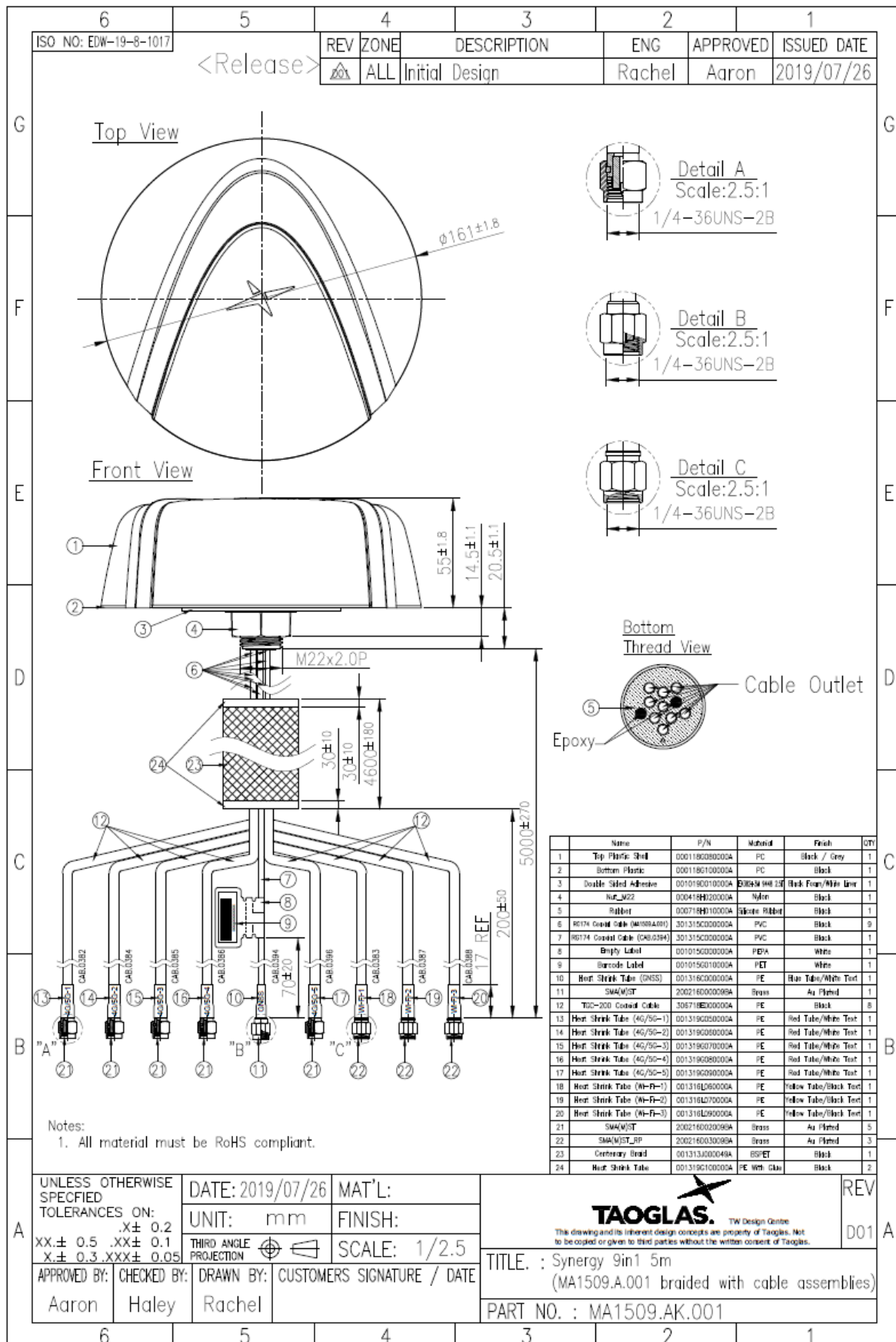

7. Packaging

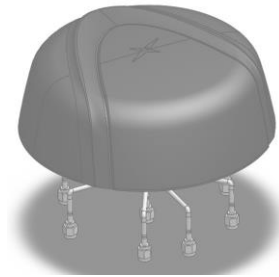

1pc MA1509.AK.001 per PE Bag
Weight: 2.7Kg

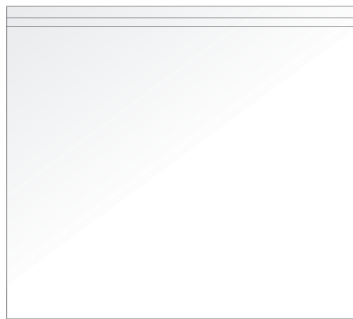

4pcs MA1509.AK.001 per Carton
Carton Dimensions: 740*370*300mm
Weight: 11.6Kg

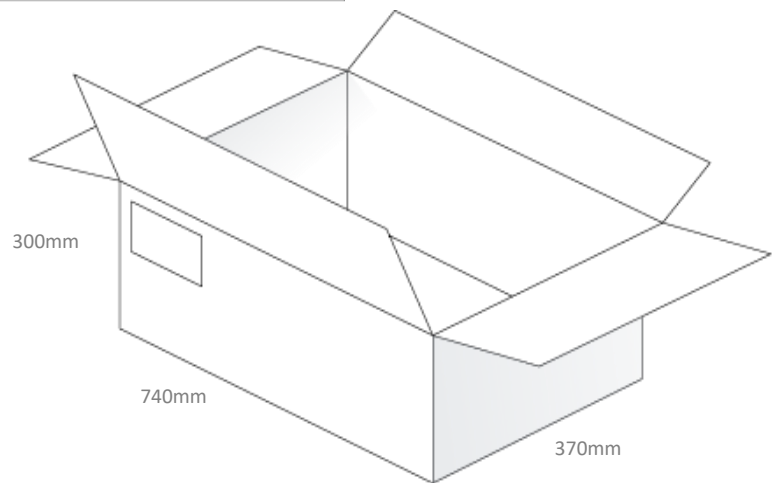

Changelog for the datasheet

SPE-20-8-004 - MA1509.AK.001

Revision: B (Current Version)

Date:	2020-05-15
Changes:	Initial Release
Changes Made by:	Jack Conroy

Previous Revisions

Revision: A (Original First Release)

Date:	2020-01-09
Notes:	Initial Release
Author:	Jack Conroy



TAOGLAS®

www.taoglas.com

