

30x30x15 mm

2.7~6.0 CFM



Specifications

	Bearing	Rating Voltage	Power Current	Power Consumption	Speed	Air Flow	Static Pressure	Noise	Weight	Curve
	• VAPO	(VDC)	(mA)	(WATTS)	(RPM)	(CFM)	(inch-H ₂ O)	(dB(A))	(g)	
MF30150V1-1000U-A99	•	5	140	0.70	9500	6.0	0.17	27.0	9.7	1
MF30150V2-1000U-A99	•	5	80	0.40	7300	4.9	0.12	20.0	9.7	2
MF30150V3-1000U-A99	•	5	45	0.23	5200	2.8	0.05	9.8	9.7	3
MF30151V1-1000U-A99	•	12	65	0.78	9500	6.0	0.17	27.0	9.7	1
MF30151V2-1000U-A99	•	12	35	0.42	7000	4.8	0.12	19.0	9.7	2
MF30151V3-1000U-A99	•	12	20	0.24	4600	2.7	0.05	7.8	9.7	3

Air Flow-Static Pressure Characteristics

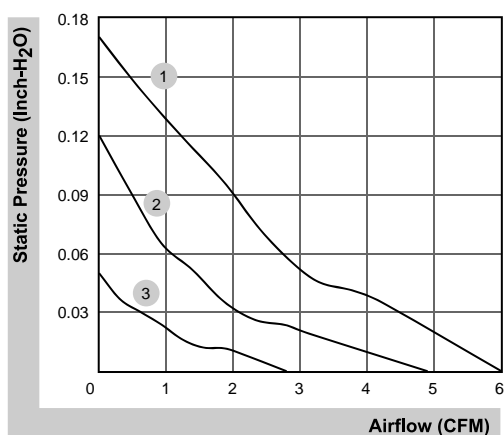

External dimensions(mm)

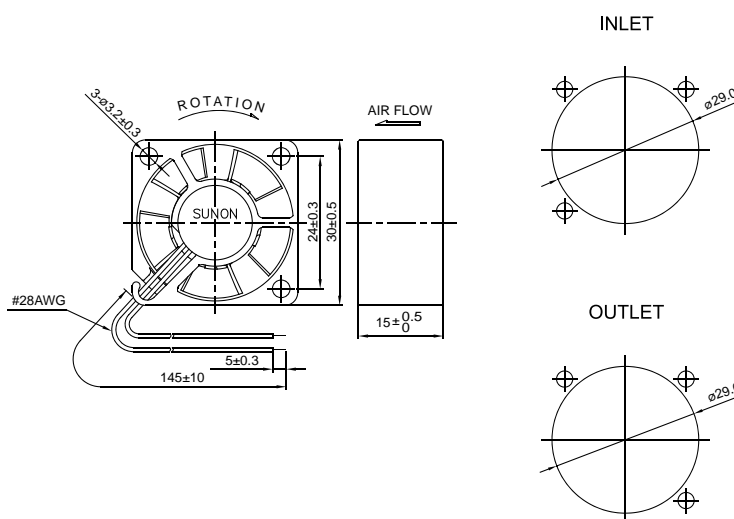

*All model could be customized. Please contact with Sunon Sales.

*Specifications are subject to change without notice. Please Visit SUNON website at www.sunon.com for update information.