

FFLB- 19" RACK MOUNTABLE RESISTIVE LOAD BANKS



- Resistive test loads suitable for 19" rack mounting or table top use
- 1, 3 & 5 KW versions available.
- 230VAC & 110VAC test voltage options available
- 240V & 115V Aux supply options available
- Forced Air cooling
- Built in over current & thermal protection.



Characteristics

Rated Power:	1KW, 3KW, 5KW
Rated Test Voltages	230VAC & 110VAC
Insulation Resistance:	>500MΩ @500V DC
Dielectric Strength :	2500V AC for 1 minute

Dimensions (mm)

Series	W	W"	D	H
FFLB-1KW	482(19")	432(19")	375	178
FFLB-3KW	482(19")	432(19")	375	311
FFLB-5KW	482(19")	432(19")	375	355

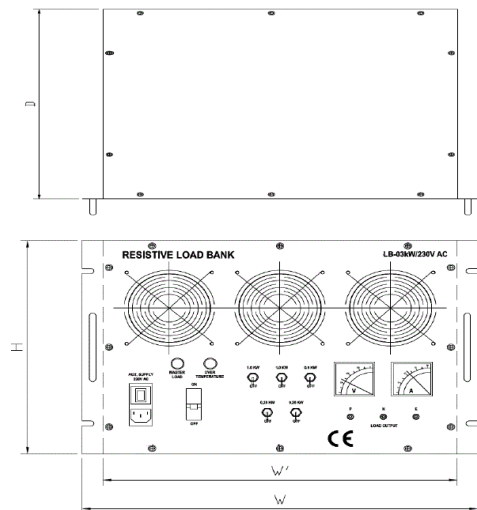
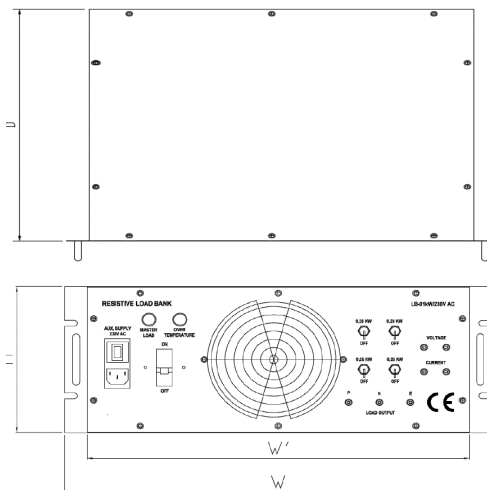

ARCOL UK Limited,
Threemilestone Ind. Estate,
Truro, Cornwall, TR4 9LG, UK.
T +44 (0) 1872 277431
F +44 (0) 1872 222002
E sales@arcolresistors.com

www.arcolresistors.com

The information contained herein does not form part of a contract and is subject to change without notice. ARCOL operate a policy of continual product development, therefore, specifications may change.

It is the responsibility of the customer to ensure that the component selected from our range is suitable for the intended application. If in doubt please ask ARCOL.

FFLB- 19" RACK MOUNTABLE RESISTIVE LOAD BANKS RESISTIVE



Ordering Procedure

Standard Resistor: Series, A to be added for 115V aux models

e.g. FFLB-1KW 230V - For 240V Aux model
FFLB-1KW 230V A - For 115V Aux models

Electrical Specifications

Type	Wattage	Current Range	Load Step Resolution
FFLB-1KW 230V	1KW	1.08A- 4.3A	0.25KW x 4
FLLB-1KW 110V	1KW	2.3A - 9.1A	0.25KW x 4
FFLB-3KW 230V	3KW	1.08A -13A	0.25kw X 2 , 0.5KW X1 , 1KW X2
FFLB-3KW 110V	3KW	2.3A - 27.3A	0.25kw X 2 , 0.5KW X1 , 1KW X2
FFLB-5KW 230V	5KW	1.08A - 21.7A	0.25kw X 2 , 0.5KW X1 , 1KW X2 2KW X 1
FFLB-5KW 110V	5KW	2.3A-45.5A	0.25kw X 2 , 0.5KW X1 , 1KW X2 2KW X 1

Standard Stocked Parts

240V AUX SUPPLY PART No

- FFLB-1KW 230V
- FFLB-1KW 110V
-
- FFLB-3KW 230V
- FFLB-3KW 110V
-
- FFLB-5KW 230V
- FFLB-5KW 110V

115V AUX SUPPLY PART No

- FFLB-1KW 230V A
- FFLB-1KW 110V A
-
- FFLB-3KW 230V A
- FFLB-3KW 110V A
-
- FFLB-5KW 230V A
- FFLB-5KW 110V A

ARCOL UK Limited,
Threemilestone Ind. Estate,
Truro, Cornwall, TR4 9LG, UK.
T +44 (0) 1872 277431
F +44 (0) 1872 222002
E sales@arcolresistors.com

www.arcolresistors.com

The information contained herein does not form part of a contract and is subject to change without notice. Arcol operate a policy of continual product development, therefore, specifications may change.

It is the responsibility of the customer to ensure that the component selected from our range is suitable for the intended application. If in doubt please ask Arcol.