





Features

- Surface mount packaging for automated assembly
- Small footprint size (1206) and low profile for space-constrained mobile applications
- Ultra-low resistance
- RoHS compliant* and halogen free**
- Agency recognition:  

Applications

- Thermal protection for Li-ion & polymer battery packs
- USB port protection - USB 2.0, 3.0 & OTG
- HDMI 1.4 Source protection
- PC motherboards - Plug & Play protection
- Mobile phones - Battery & port protection
- PDAs / digital cameras
- Game console port protection

MF-NSML Series - Low Ohmic PTC Resettable Fuses

Electrical Characteristics

Model	V max. Volts	I max. Amps	I _{hold}	I _{trip}	Resistance		Max. Time To Trip		Tripped Power Dissipation
			Amperes at 23 °C		Ohms at 23 °C		Amperes at 23 °C	Seconds at 23 °C	Watts at 23 °C
			Hold	Trip	R _{Min.}	R _{1Max.}			Typ.
MF-NSML150	6	50	1.50	3.00	0.0100	0.0650	8.00	0.50	0.8
MF-NSML175	6	50	1.75	3.50	0.0050	0.0400	8.00	0.50	0.8
MF-NSML190	6	50	1.90	4.90	0.0050	0.0300	8.00	1.00	0.8
MF-NSML200	6	50	2.00	4.00	0.0050	0.0300	8.00	1.00	0.8
MF-NSML260	6	50	2.60	5.20	0.0030	0.0260	8.00	4.00	0.8
MF-NSML300	6	50	3.00	6.00	0.0025	0.0200	8.00	4.00	0.8
MF-NSML350	6	50	3.50	7.00	0.0020	0.0180	8.00	5.00	0.8
MF-NSML380	6	50	3.80	8.00	0.0015	0.0140	8.00	5.00	0.8
MF-NSML400	6	50	4.00	8.00	0.0015	0.0140	8.00	5.00	0.8
MF-NSML450***	6	50	4.50	9.00	0.0010	0.0140	22.5	2.00	0.8
MF-NSML500***	6	50	5.00	10.0	0.0010	0.0120	25.0	2.00	0.8
MF-NSML550***	6	50	5.50	11.0	0.0010	0.0110	27.5	2.00	0.8
MF-NSML600***	6	50	6.00	12.0	0.0010	0.0100	30.0	2.00	0.8

*** TÜV approval pending.

Environmental Characteristics

Operating Temperature.....	-40 °C to +85 °C
Passive Aging.....	+85 °C, 1000 hours..... ±10 % typical resistance change
Humidity Aging.....	+85 °C, 85 % R.H. 100 hours..... ±15 % typical resistance change
Thermal Shock.....	+85 °C to -40 °C, 20 times..... ±30 % typical resistance change
Solvent Resistance.....	MIL-STD-202, Method 215..... No change
Vibration.....	MIL-STD-883C, Method 2007.1..... No change
	Condition A
Moisture Sensitivity Level (MSL).....	Level 1
ESD Classification - HBM.....	Class 6

Test Procedures And Requirements For Model MF-NSML Series

Test	Test Conditions	Accept/Reject Criteria
Visual/Mech.....	Verify dimensions and materials.....	Per MF physical description
Resistance.....	In still air @ 23 °C.....	$R_{min} \leq R \leq R_{1max}$
Time to Trip.....	At specified current, V _{max} , 23 °C.....	$T \leq \text{max. time to trip (seconds)}$
Hold Current.....	30 min. at I _{hold}	No trip
Trip Cycle Life.....	V _{max} , I _{max} , 100 cycles.....	No arcing or burning
Trip Endurance.....	V _{max} , 48 hours.....	No arcing or burning
Solderability.....	ANSI/J-STD-002.....	95 % min. coverage

cUL File Number..... E174545
<http://www.ul.com/> Follow link to Online Certificates Directory, then enter cUL File No. E174545, or [click here](#)

TÜV Certificate Number..... R 02057213
<http://www.tuvdotcom.com/> Follow link to "other certificates", enter File No. 2057213, or [click here](#)

* RoHS Directive 2002/95/EC Jan. 27, 2003 including annex and RoHS Recast 2011/65/EU June 8, 2011.

**Bourns considers a product to be "halogen free" if (a) the Bromine (Br) content is 900 ppm or less; (b) the Chlorine (Cl) content is 900 ppm or less; and (c) the total Bromine (Br) and Chlorine (Cl) content is 1500 ppm or less.

Specifications are subject to change without notice.

The device characteristics and parameters in this data sheet can and do vary in different applications and actual device performance may vary over time.

Users should verify actual device performance in their specific applications.

MF-NSML Series - Low Ohmic PTC Resettable Fuses

BOURNS®

Product Dimensions

Model	A		B		C		D	E	
	Min.	Max.	Min.	Max.	Min.	Max.	Min.	Min.	Max.
MF-NSML150	3.00 (0.118)	3.50 (0.138)	1.40 (0.055)	1.80 (0.071)	0.30 (0.012)	0.60 (0.024)	0.25 (0.010)	0.05 (0.002)	0.45 (0.018)
MF-NSML175									
MF-NSML190									
MF-NSML200									
MF-NSML260									
MF-NSML300									
MF-NSML350									
MF-NSML380									
MF-NSML400	3.00 (0.118)	3.50 (0.138)	1.40 (0.055)	1.80 (0.071)	0.60 (0.024)	1.20 (0.047)	0.25 (0.010)	0.05 (0.002)	0.45 (0.018)
MF-NSML450									
MF-NSML500									
MF-NSML550									
MF-NSML600									

Packaging:

MF-NSML150~MF-NSML400 = 5000 pcs. per reel

MF-NSML450~MF-NSML600 = 3500 pcs. per reel

DIMENSIONS: $\frac{\text{MM}}{\text{(INCHES)}}$

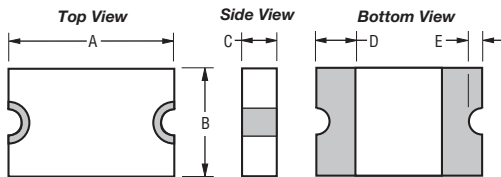

Recommended Pad Layout

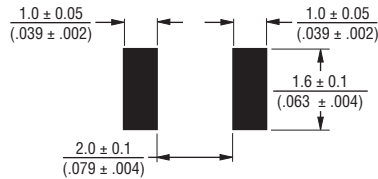

Terminal material:

ENIG-plated terminals
(Tin-plated terminals available upon request).

Termination pad solderability:

Meets ANSI/J-STD-002 Category 2.

Recommended Storage:

40 °C max./70 % RH max.

Thermal Derating Chart - I_{hold} (Amps)

Model	Ambient Operating Temperature								
	-40 °C	-20 °C	0 °C	23 °C	40 °C	50 °C	60 °C	70 °C	85 °C
MF-NSML150	2.67	2.32	1.95	1.50	1.15	0.96	0.78	0.64	0.52
MF-NSML175	2.57	2.33	2.07	1.75	1.49	1.34	1.24	1.00	0.91
MF-NSML190	2.89	2.58	2.25	1.90	1.54	1.36	1.21	0.94	0.77
MF-NSML200	3.30	2.90	2.50	2.00	1.62	1.39	1.16	0.90	0.52
MF-NSML260	3.71	3.42	3.01	2.60	2.08	1.72	1.49	1.30	0.89
MF-NSML300	4.41	3.99	3.54	3.00	2.55	2.32	2.13	1.71	1.56
MF-NSML350	5.51	4.66	4.13	3.50	2.98	2.71	2.49	2.00	1.82
MF-NSML380	5.59	5.05	4.48	3.80	3.23	2.95	2.70	2.17	1.98
MF-NSML400	5.71	5.26	4.63	4.00	3.20	2.70	2.29	2.00	1.37
MF-NSML450	6.62	5.99	5.31	4.50	3.83	3.50	3.20	2.57	2.34
MF-NSML500	7.35	6.66	5.90	5.00	4.25	3.88	3.55	2.85	2.60
MF-NSML550	8.09	7.32	6.49	5.50	4.68	4.27	3.91	3.41	2.86
MF-NSML600	8.82	7.98	7.08	6.00	5.10	4.66	4.26	3.43	3.12

Specifications are subject to change without notice.

The device characteristics and parameters in this data sheet can and do vary in different applications and actual device performance may vary over time.

Users should verify actual device performance in their specific applications.

MF-NSML Series - Low Ohmic PTC Resettable Fuses



Solder Reflow Recommendations

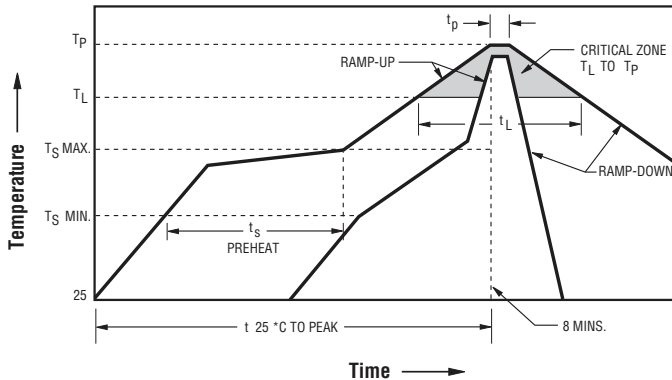

Notes:

- MF-NSML models cannot be wave soldered or hand soldered. Please contact Bourns for soldering recommendations.
- All temperatures refer to topside of the package, measured on the package body surface.
- If reflow temperatures exceed the recommended profile, devices may not meet the published specifications.
- Compatible with Pb and Pb-free solder reflow profiles.
- Excess solder may cause a short circuit, especially during hand soldering. Please refer to the Multifuse® Polymer PTC Soldering Recommendation guidelines.
- Designed for single solder reflow operations.

Profile Feature	Pb-Free Assembly
Average Ramp-Up Rate ($T_{S_{max}}$ to T_p)	3 °C / second max.
PREHEAT: Temperature Min. ($T_{S_{min}}$) Temperature Max. ($T_{S_{max}}$) Time ($t_{s_{min}}$ to $t_{s_{max}}$)	150 °C 200 °C 60~180 seconds
TIME MAINTAINED ABOVE: Temperature (T_L) Time (t_L)	217 °C 60~150 seconds
Peak / Classification Temperature (T_p)	260 °C
Time within 5 °C of Actual Peak Temperature (t_p)	20~40 seconds
Ramp-Down Rate	6 °C / second max.
Time within 25 °C to Peak Temperature	8 minutes max.

How to Order

MF - NSML 200 - 2

Multifuse® Product Designator _____
 Series _____
 NSML = 1206 Low Ohmic Surface Mount Component
 Hold Current, I_{hold} _____
 150 - 600 (1.50 Amps - 6.00 Amps)
 Packaging _____
 Packaged per EIA 481-1
 -2 = Tape and Reel

Typical Part Marking

Represents total content. Layout may vary.

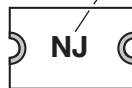

PART IDENTIFICATION:
 MF-NSML150 = NG
 MF-NSML175 = NH
 MF-NSML190 = NI
 MF-NSML200 = NJ
 MF-NSML260 = NN
 MF-NSML300 = NP
 MF-NSML350 = NS
 MF-NSML380 = NV
 MF-NSML400 = NU
 MF-NSML450 = NX
 MF-NSML500 = NY
 MF-NSML550 = N5
 MF-NSML600 = NZ

MANUFACTURING DATE CODE IS LOCATED ON PACKING LABEL.



Asia-Pacific:

Tel: +886-2 2562-4117
 Email: asiacus@bourns.com

Europe:

Tel: +36 88 520 390
 Email: eurocus@bourns.com

The Americas:

Tel: +1-951 781-5500
 Email: americus@bourns.com

www.bourns.com

MF-NSML SERIES, REV. G, 08/17

Specifications are subject to change without notice.

The device characteristics and parameters in this data sheet can and do vary in different applications and actual device performance may vary over time. Users should verify actual device performance in their specific applications.

MF-NSML Series - Low Ohmic PTC Resettable Fuses

BOURNS®

Tape Dimensions	MF-NSML Series per EIA 481-2
W	12.0 ± 0.30 (0.472 ± 0.012)
P ₀	4.0 ± 0.10 (0.157 ± 0.004)
P ₁	4.0 ± 0.10 (0.157 ± 0.004)
P ₂	2.0 ± 0.05 (0.079 ± 0.002)
A ₀	1.90 ± 0.10 (0.075 ± 0.004)
B ₀	3.50 ± 0.10 (0.138 ± 0.004)
B ₁ max.	4.5 (0.177)
D ₀	$1.5 + 0.10/-0.0$ (0.059 + 0.004/-0)
F	5.5 ± 0.05 (0.216 + 0.002)
E ₁	1.75 ± 0.10 (0.069 ± 0.004)
E ₂ typ.	10.25 (0.404)
T max.	0.6 (0.024)
T ₁ max.	0.1 (0.004)
K ₀ (MF-NSML150~MF-NSML400)	0.65 ± 0.10 (0.026 ± 0.004)
K ₀ (MF-NSML450~MF-NSML600)	1.10 ± 0.10 (0.043 ± 0.004)
Leader min.	390 (15.35)
Trailer min.	160 (6.30)
Reel Dimensions	
A max.	185 (7.283)
N min.	50 (1.97)
W ₁	$12.4 + 1/-0$ (0.488 + 0.039/-0)
W ₂ max.	15.4 (0.606)

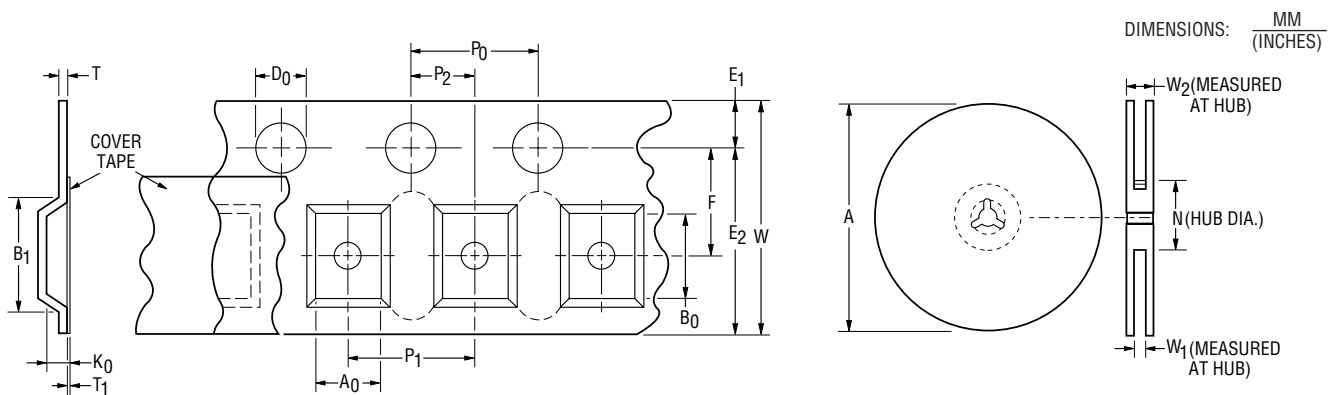

Specifications are subject to change without notice.
 The device characteristics and parameters in this data sheet can and do vary in different applications and actual device performance may vary over time.
 Users should verify actual device performance in their specific applications.