

Screening Grid Retainer for PNBC

ZNBS005

Part Number



Technical Data

Mechanical Data

Material	Aluminum
Weight	30 g
Packaging unit	1 Piece

● Captive mounting kit

Complementary Products

ZNBE002, ZNBE004 Protective Screen

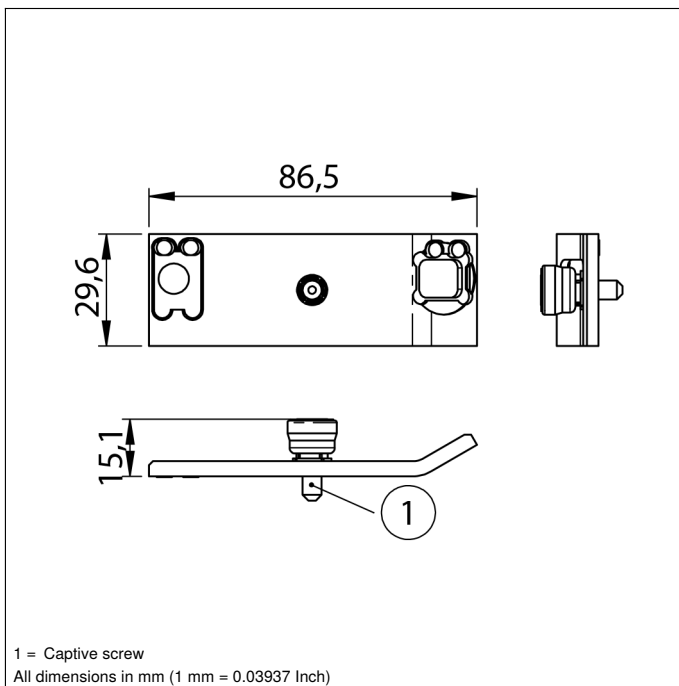

Protective discs must be ordered separately (not included in scope of delivery)