

Part No. M830120

GPS Savvi™ Ceramic Antennas

1.575GHz



Ethertronics' Savvi series of Isolated Magnetic Dipole™ (IMD) antennas deliver on the key needs of device designers for higher functionality and performance in smaller/thinner designs. These innovative antennas provide compelling advantages for a GPS enabled handheld devices, media players and other mobile devices.

Real-World Performance and Implementation

Ceramic antennas may look alike on the outside, but the important difference is inside. Other antennas may contain simple PiFA or monopole designs that interact with their surroundings, complicating layout or changing performance with use position. Ethertronics' antennas utilize patented IMD technology to deliver a unique size and performance combination.

Savvi™ Ceramic Antennas

GPS

1.575 GHz

Greater Flexibility

Ethertronics' first-in-class IMD technology enables you to develop concept designs that are more advanced and that deliver superior performance in reception critical applications.

KEY BENEFITS

Stay-in-Tune

IMD antenna technology provides superior RF field containment, resulting in less interaction with surrounding components.

Quicker Time-to-Market

By optimizing antenna size, performance and emissions, customer and regulatory specifications are more easily met.

Reliability

Fully compliant with the European RoHS Directive 2011/65/EU.

APPLICATIONS

- Embedded design
- Cellular, Headsets, Tablets
- Gateway, Access Point
- M2M, Industrial devices
- Handheld

Electrical Specifications

Typical Characteristics, on 40x80mm PCB

Frequency	1.575GHz
Peak Gain	1.78 dBi
Average Efficiency	75%
VSWR Match	1.7:1 max
Feed Point Impedance	50 ohms unbalanced
Polarization	Linear
Power Handling	0.5 Watt CW

Mechanical Specifications

Size	8.0x3.0x1.3mm
Mounting	Surface mount
Weight	0.2 g
Packaging	Tape & Reel, M830120 – 1,000 pieces per reel M830120-4.5K – 4,500 pieces per reel
Demo Board	M830120-01

1.575GHz Ethertronics' Savvi™ Embedded Antenna Specifications
 Ethertronics produces a wide variety of standard and custom antennas to meet user needs.
 Below are the typical performances.

Typical Return Loss and Efficiency Plots

Measured on 40x80mm demo board

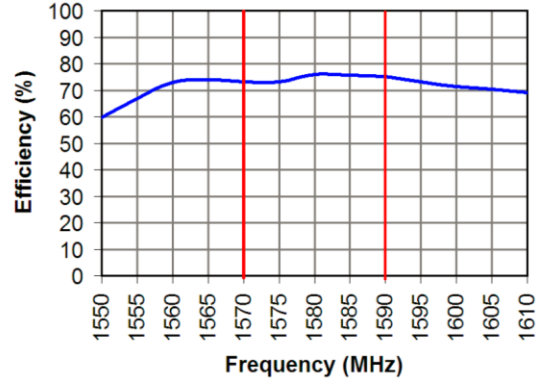
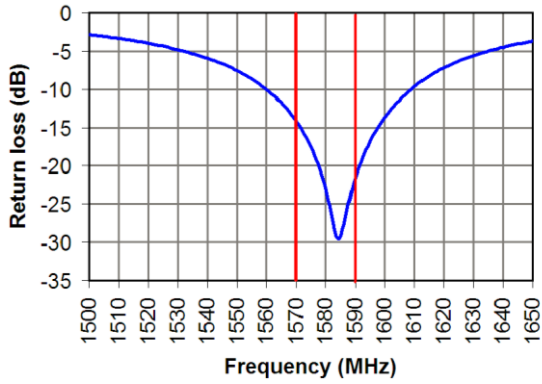

Antenna Radiation Patterns

Typical Performances on Ethertronics' 40x80 PCB Test Board

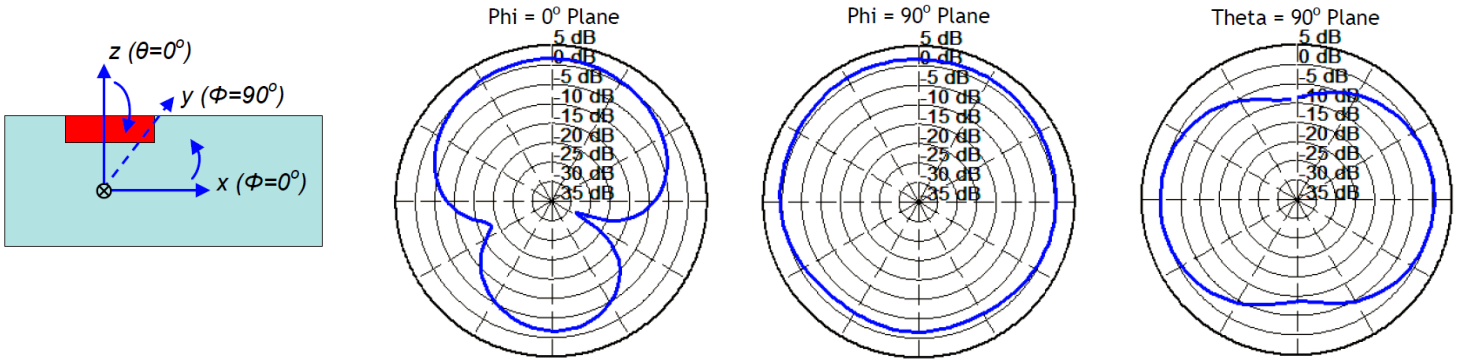

Antenna Layout

For references only, tunina varies based on application

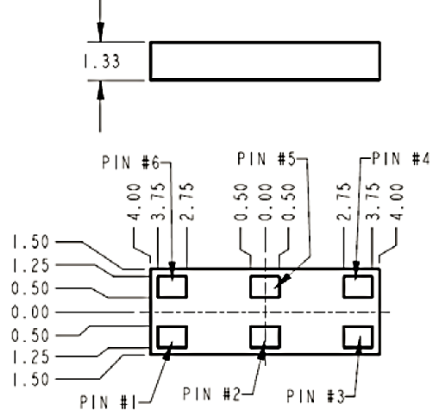
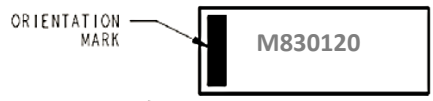
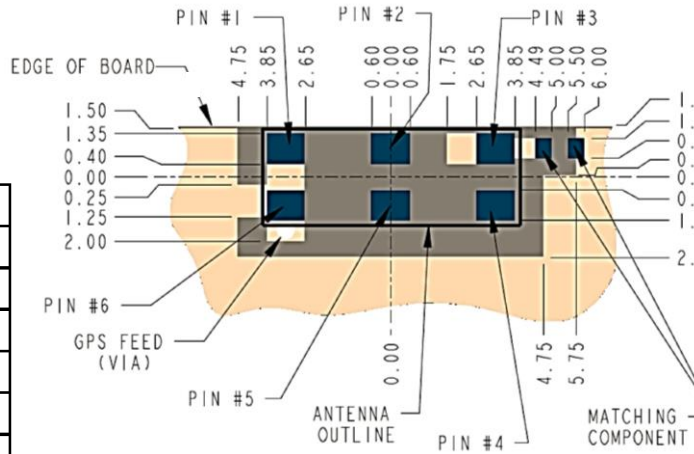
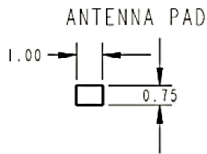

Pin	Description
1	Ground
2	Dummy Pad
3	Matching Circuit Connection
4	Dummy Pad
5	Dummy Pad
6	Ground/GPS Feed*

*All dimensions provided in this document are for informational purposes only.