

Shims for thread-turning tool holder

For inserting into thread-turning tool holder no. 17745-17747

ATORN[®]

Application

For inserting into thread-turning tool holder no. 17745-17747. Sets the thread-turning insert at the correct angle.

Version

- Shims for thread-turning tool holder

Advantage

- Precision-ground for a high degree of dimensional accuracy

Delivery

Shim

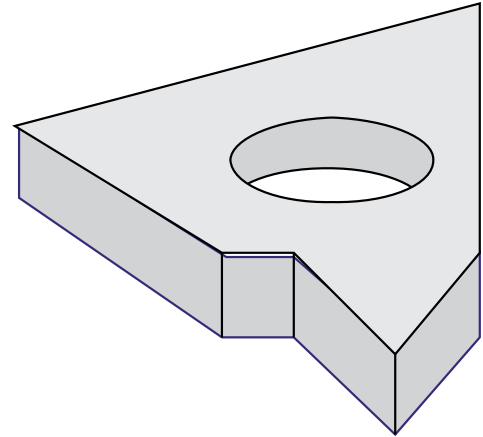

Art. no.	17749 758
Base plate code	AI 22 -1.5
Resulting pitch angle	-1.5°
Suitable for indexable insert size	22
Suitable for holder	EL/IR

EAN-Code

4050293204872