

# ST-4

## SURFACE MOUNT CERMET TRIMMERS (SINGLE TURN)

### RoHS compliant

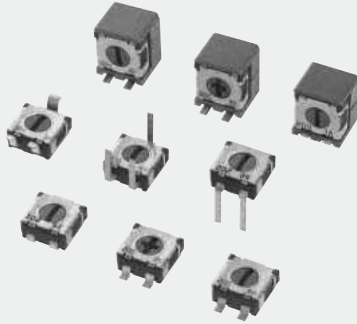

### FEATURES

- RoHS compliant
- Wide variety (7 types) to choose from
- Automatic mounting is possible (Taping)
- Flow/reflow soldering is possible
- Sealed construction (Washable)
- Stopper structure prevents terminal pin from being open.
- Cross slot rotor suitable for automatic adjustment

### INTERNAL STRUCTURE

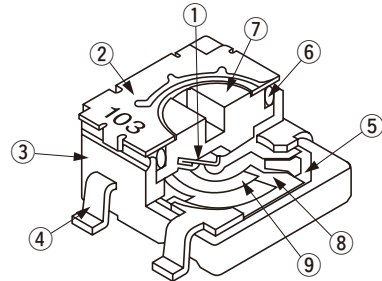

	Part name	Material	Flammability
①	Wiper	Multi metal alloy	—
②	Cover	Stainless steel (SUS 304)	
③	Housing	Epoxy	UL-94V-0
④	Terminal pin	Copper alloy, Sn-Cu-plated	—
⑤	Base element	Ceramic	
⑥	“O” ring	Silicone rubber	UL-94HB
⑦	Rotor	Polyphenylenesulphide	UL-94V-0
⑧	Electrode	Ag-Pd cermet	—
⑨	Resistive element	RuO <sub>2</sub> cermet	

CFCs, Halon, Carbon tetrachloride and designated bromic flame retardant PBBOs and PBBs are not used in our products.

### PART NUMBER DESIGNATION

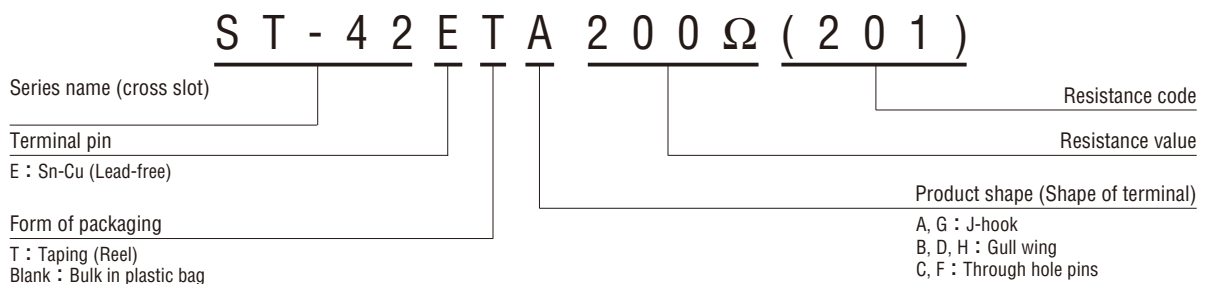
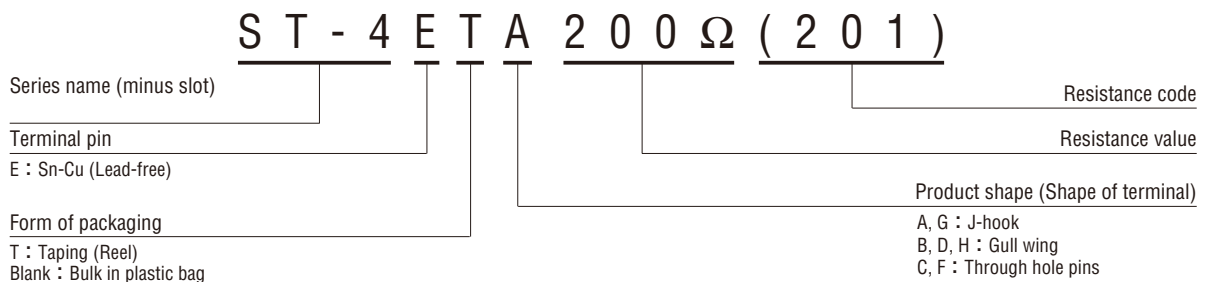

※ Please refer to the LIST OF PART NUMBERS when placing orders.

# ST-4 SURFACE MOUNT TRIMMERS

## LIST OF PART NUMBERS

Adjustment position	Shape of terminal	Form of packaging	
		Taping (reel)	Plastic bag
Top adjustment	A ( J-hook )	ST-4/42ETA	ST-4/42EA
	B ( Gull wing )	ST-4/42ETB	ST-4/42EB
	C ( Through hole pins )		ST-4/42EC
Rear adjustment	D ( Gull wing )	ST-4/42ETD	ST-4/42ED
	F ( Through hole pins )		ST-4/42EF
Side adjustment	G ( J-hook )	ST-4/42ETG	ST-4/42EG
	H ( Gull wing )	ST-4/42ETH	ST-4/42EH
Pieces in package		500 pcs./reel	100 pcs./pack

The products indicated by  $\rightarrow$  mark are manufactured upon receipt of order basis.  
 ※  $\ominus$  slot : ST-4E $\square$ ,  $\oplus$  slot : ST-42E $\square$

## ELECTRICAL CHARACTERISTICS

Nominal resistance range	10 $\Omega$ ~ 2 M $\Omega$
Resistance tolerance	$\pm$ 20 %
Power ratings	0.25 W (70 °C) 0 W (125 °C)
Resistance law	Linear law (B)
Maximum input voltage	DC200 V or power rating, whichever is smaller
Maximum wiper current	100 mA or power rating, whichever is smaller
Effective electrical angle	210° (1 turn)
End resistance	1 % or 2 $\Omega$ , whichever is greater
C.R.V.	1 % or 3 $\Omega$ , whichever is greater
Operating temp. range	-55 ~ 125 °C
Temp. coefficient	10 $\Omega$ ~ 50 $\Omega$ : $\pm$ 250 10 <sup>-6</sup> /°C maximum 100 $\Omega$ ~ 2 M $\Omega$ : $\pm$ 100 10 <sup>-6</sup> /°C maximum
Insulation resistance	1000 M $\Omega$ minimum (DC500 V)
Dielectric strength	AC500 V, 60 s
Net weight	Approx. 0.12 g (ST-4EA, EB, EC, ED, EF) Approx. 0.22 g (ST-4EG, EH)

### <Reflow profile for soldering heat evaluation>

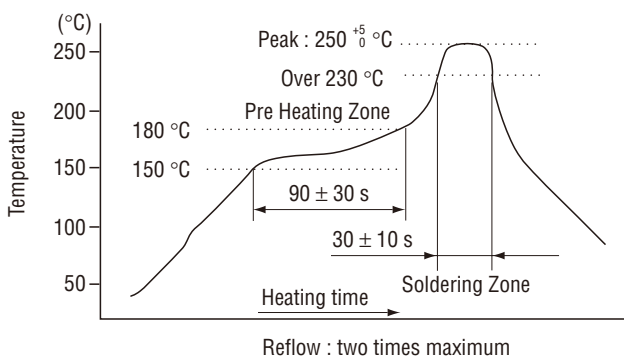

### <Nominal resistance values>

$\rightarrow$ 10 $\Omega$	$\rightarrow$ 20 $\Omega$	50 $\Omega$	100 $\Omega$	200 $\Omega$	500 $\Omega$	1 k $\Omega$	2 k $\Omega$	5 k $\Omega$
10 k $\Omega$	20 k $\Omega$	50 k $\Omega$	100 k $\Omega$	200 k $\Omega$	500 k $\Omega$	1 M $\Omega$	2 M $\Omega$	

Fig. 1

$\square$  : Not manufactured

※ The above part numbers are all available with the respective combination of <Nominal resistance values> (Fig. 1).

※ Verify the above part numbers when placing orders.

※ Taping specification is not sold separately and must be purchased in reel units.

※ Cross slot available : ST-42E $\square$

## MECHANICAL CHARACTERISTICS

Mechanical angle	240° (1 turn)
Operating torque	10 mN·m {102 gf·cm} maximum
Stop strength	30 mN·m {306 gf·cm} minimum
Rotational life	100 cycles [ $\Delta$ R/R $\leq$ $\pm$ (2 $\Omega$ + 3 %) ]
Thrust to rotor	5 N {0.51 kgf} minimum
Solderability	245 $\pm$ 3 °C, 2 ~ 3 s
Shear (Adhesion)	5 N {0.51 kgf} 10 s
Substrate bending	Width 90 mm, bend 3 mm, 5 s, 1 time
Pull-off strength	5 N {0.51 kgf} 10 s

{ } : Reference only

## ENVIRONMENTAL CHARACTERISTICS

Test item	Test conditions	Specifications
Thermal shock	-65 ~ 125 °C (0.5 h), 5 cycles	[ $\Delta$ R/R $\leq$ 2 % ] [ S.S. $\leq$ 1 % ]
Humidity	-10 ~ 65 °C (80 ~ 98 %), 10 cycles, 240 h	[ $\Delta$ R/R $\leq$ 2 % ]
Shock	981 m/s <sup>2</sup> , 6 ms 6 directions for 3 times each	[ $\Delta$ R/R $\leq$ 1 % ] [ S.S. $\leq$ 1 % ]
Vibration	Amplitude 1.52 mm or Acceleration 196 m/s <sup>2</sup> , 10 ~ 2000 Hz, 3 directions, 12 times each	[ $\Delta$ R/R $\leq$ 1 % ] [ S.S. $\leq$ 1 % ]
Load life	70 °C, 0.25 W 1000 h	[ $\Delta$ R/R $\leq$ 3 % ] [ S.S. $\leq$ 1 % ]
Low temp. operation	-55 °C, 2 h	[ $\Delta$ R/R $\leq$ 2 % ] [ S.S. $\leq$ 2 % ]
High temp. exposure	125 °C, 250 h	[ $\Delta$ R/R $\leq$ 3 % ] [ S.S. $\leq$ 2 % ]
Immersion seal	85 °C, 60 s	No leaks (No continuous bubbles)
Soldering heat	Flow : 260 $\pm$ 3 °C as the temperature in a pot of molten solder, immersion from head of terminal to backside of board, 5 ~ 6 s, two times maximum Reflow : Peak temperature 255 °C (Please refer to the profile below.) Manual soldering : 350 $\pm$ 10 °C, 3 ~ 4 s	[ $\Delta$ R/R $\leq$ 1 % ]

$\Delta$ R/R : Change in total resistance  
S.S. : Setting stability

# ST-4 SURFACE MOUNT TRIMMERS

## ■ MAXIMUM INPUT RATINGS

Nominal resistance values ( $\Omega$ )	Resistance code	Maximum input voltage (V)	Maximum wiper current (mA)
↻ 10 ↻ 20 50 100 200 500	100 200 500 101 201 501	1.00 2.00 3.53 5.00 7.07 11.2	100 100 70.7 50.0 35.4 22.4
1 k 2 k 5 k 10 k 20 k 50 k	102 202 502 103 203 503	15.8 22.4 35.4 50.0 70.7 112	15.8 11.2 7.07 5.00 3.54 2.24
100 k 200 k 500 k 1 M 2 M	104 204 504 105 205	158 200 200 200 200	1.58 1.00 0.40 0.20 0.10

The products indicated by ↻ mark are manufactured upon receipt of order basis.

## ■ RECOMMENDED P.C.B. PAD OUTLINE DIMENSIONS

● ST-4EA

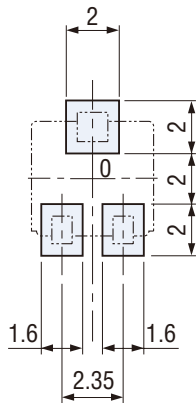

● ST-4EB

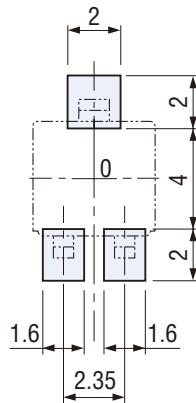

● ST-4ED

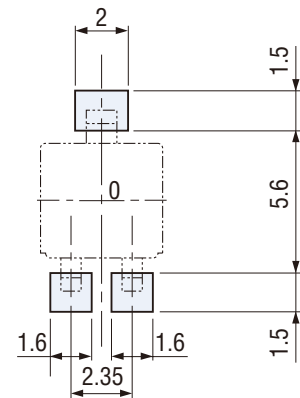

(Unit: mm)

● ST-4EG

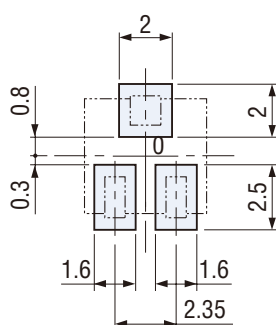

● ST-4EH

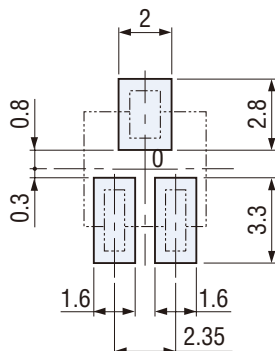

Note) The zero point is the center of mounting.

# ST-4 SURFACE MOUNT TRIMMERS

## OUTLINE DIMENSIONS

Unless otherwise specified, tolerance :  $\pm 0.3$  (Unit: mm)

### ST-4EA Top adjustment

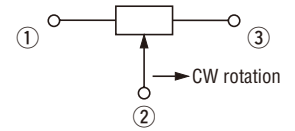
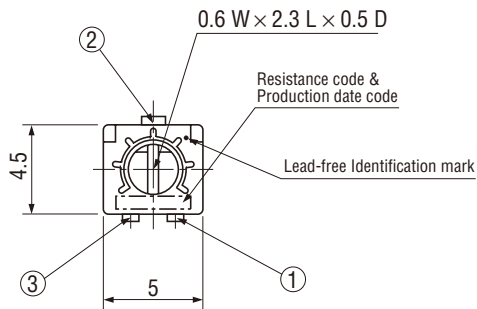

※Note the terminal position.

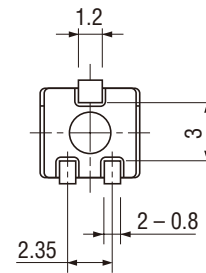

### ST-4EB Top adjustment

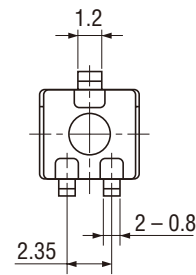
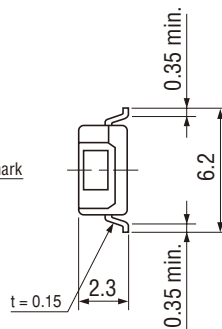
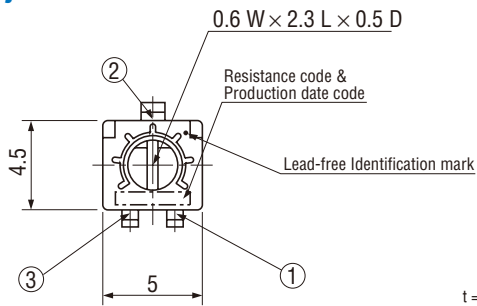

### ST-4EC Top adjustment

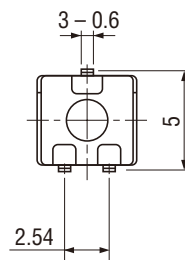
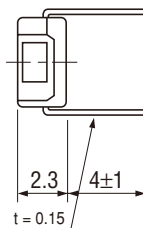
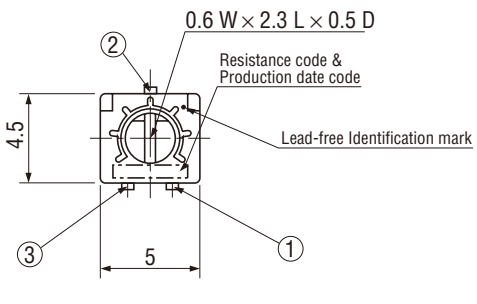

### ST-4EG Side adjustment

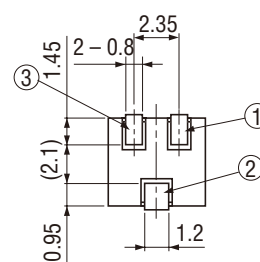
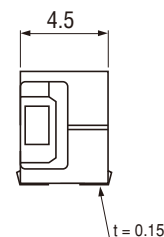
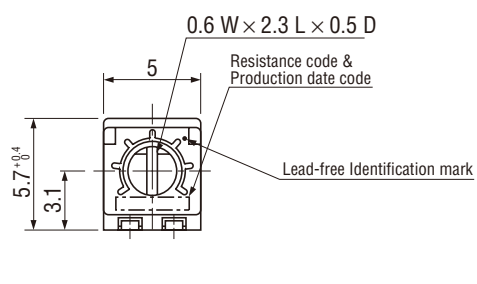

## ST-4 SURFACE MOUNT TRIMMERS

### OUTLINE DIMENSIONS

Unless otherwise specified, tolerance :  $\pm 0.3$  (Unit: mm)

#### ST-4EH Side adjustment

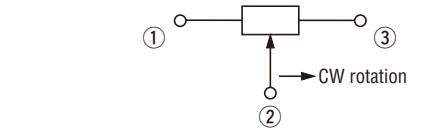
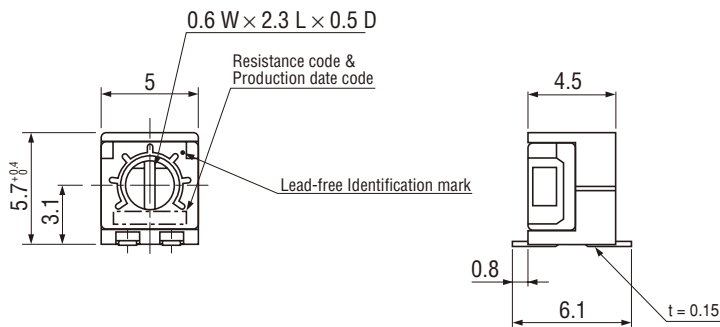

※Note the terminal position.

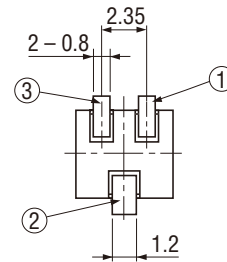

#### ST-4ED Rear adjustment

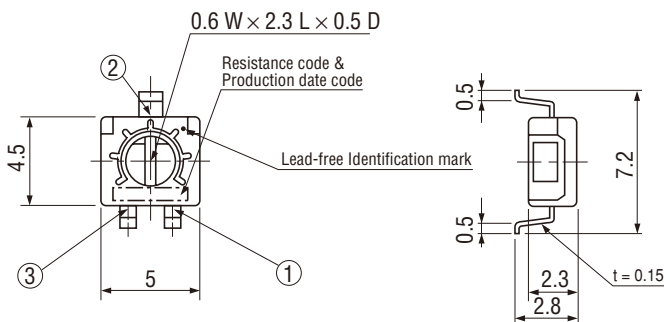

< Semi-standard products >

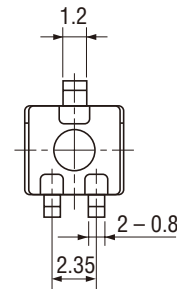

#### ST-4EF Rear adjustment

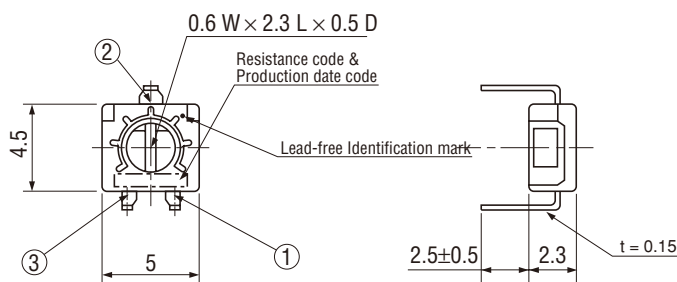

< Semi-standard products >

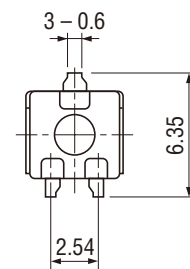

#### ST-42E CROSS SLOT DIMENSION

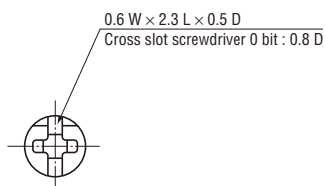

# ST-4 SURFACE MOUNT TRIMMERS

## ■ PACKAGING SPECIFICATIONS

### <Taping packaging specifications>

- Taping version is packaged in 500 pcs. per reel.  
Orders will be accepted for units of 500 pcs., i.e., 500, 1000, 1500 pcs., etc.
- ST-4ETA, ETB and ETD versions are boxed with 4 reels (2000 pcs.).  
ST-4ETG and ETH versions are boxed with one reel (500 pcs.).

Maximum number of consecutive missing pieces = 2  
Leader length and reel dimension are shown in the dia-diagrams below.

## ● EMBOSSED TAPE DIMENSIONS

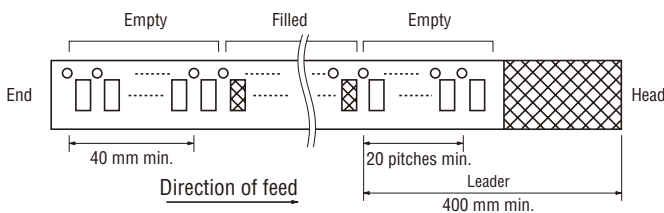

## ● REEL DIMENSIONS

(Conforms to JIS C 0806-3)

(In accordance with EIAJ ET-7200A)

(Unit: mm)

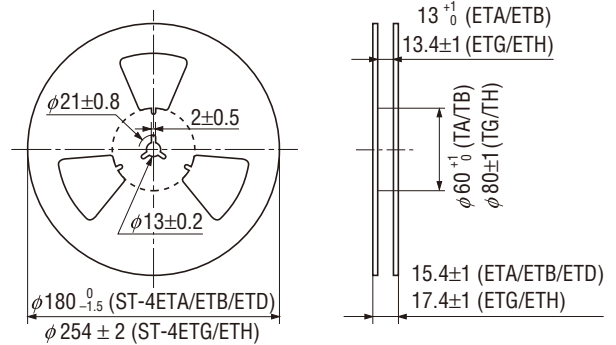

## ● ST-4ETA/ETB/ETD

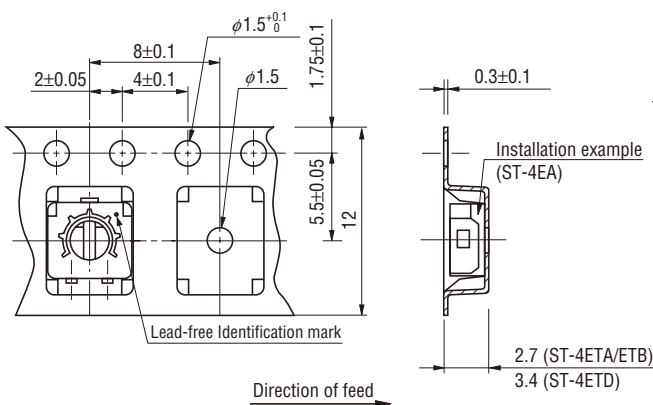

## ● ST-4ETG/ETH

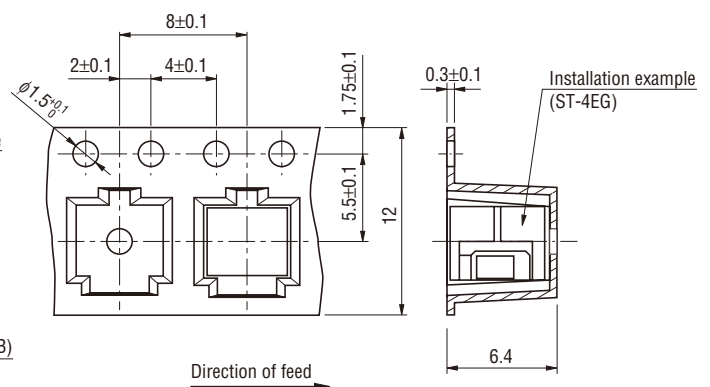

### <Bulk pack specifications>

- Unit of bulk in a plastic bag is 100 pcs. per pack.
- Boxing of bulk in a plastic bag is performed with 500 pcs. per box.