

- Ground
- Power
- LED
- Internal Pin
- Microcontroller's Port
- High Density Connector

GND is common through the board



TEMPERATURE PROBES

TERMOUCOUPLE SUPPORTED **J** **K**

Connection diagram:



CONNECT THE THERMOUCOUPLE NEGATIVE TO TN, NOT TO GND

RTD SUPPORTED **PT100** **PT1000**

Connection diagram, with 2 wires RTD:



ADD JUMPER BETWEEN TP* AND RTD* PINS

Connection diagram, with 3 wires RTD:

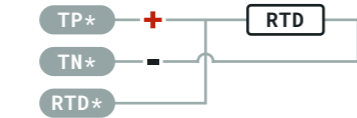

⚠️ TEMPERATURE PROBES PINS CAN BE CONNECTED ONLY WITH COMPATIBLES THERMOUCOUPLES OR RTDs, NO DIRECT VIN SHOULD BE CONNECTED TO THE PINS

ANALOG INPUTS

THE 3 ANALOG INPUT PINS CAN MEASURE VOLTAGE IN 3 WAYS:

0-10V function (DEFAULT):



4-20mA function:



NTC function:



All +24V OUT ANALOG INPUT pins are connected and protected by a single PTC.



PTC MAXIMUM CURRENT IS 500mA

⚠️ DO NOT CONNECT DIRECTLY +24V IN OR +24V OUT TO AI*

⚠️ BE CAREFUL BEFORE CHANGING THE FUNCTION THAT THE WIRING IS CORRECTLY DONE, HIGH RISK OF BOARD DAMAGE!

ANALOG OUTPUTS

Each pin can be independently set up to 10V and can source up to 20mA.

HMI - COMM PROTOCOLS

+24V OUT is protected with a PTC.



PTC MAXIMUM CURRENT IS 500mA

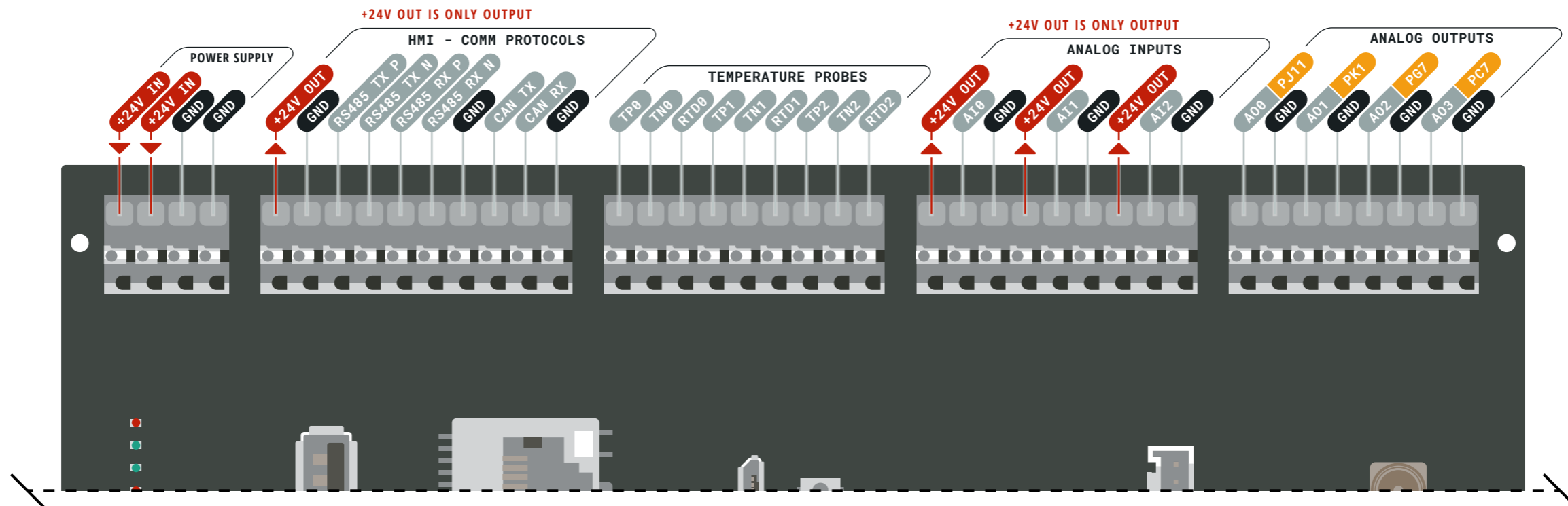

- Ground
- Power
- LED
- Internal Pin
- Microcontroller's Port
- High Density Connector

GND is common through the board



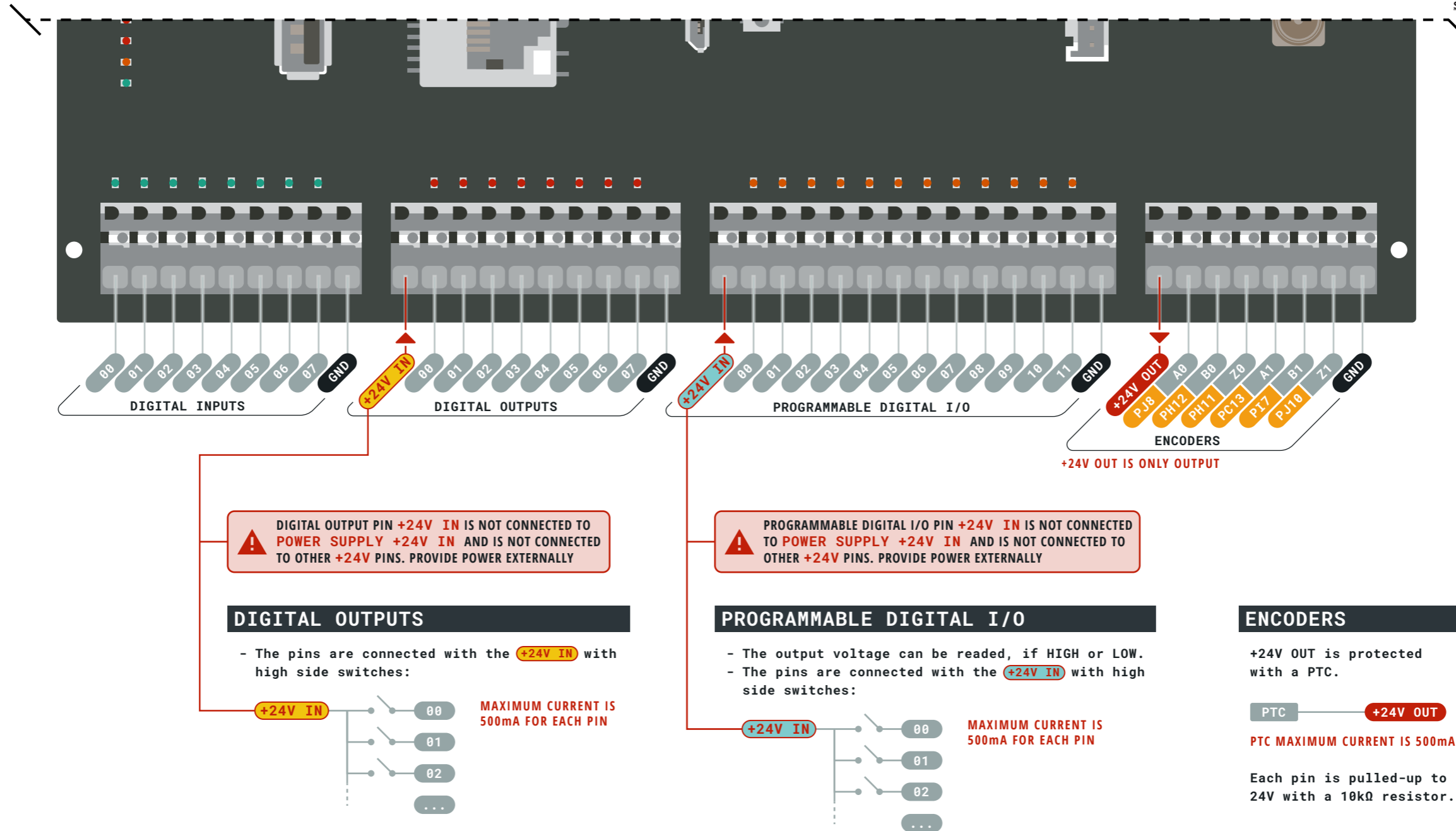

- Ground
- Power
- LED
- Internal Pin

- Microcontroller's Port
- High Density Connector

GND is common through the board



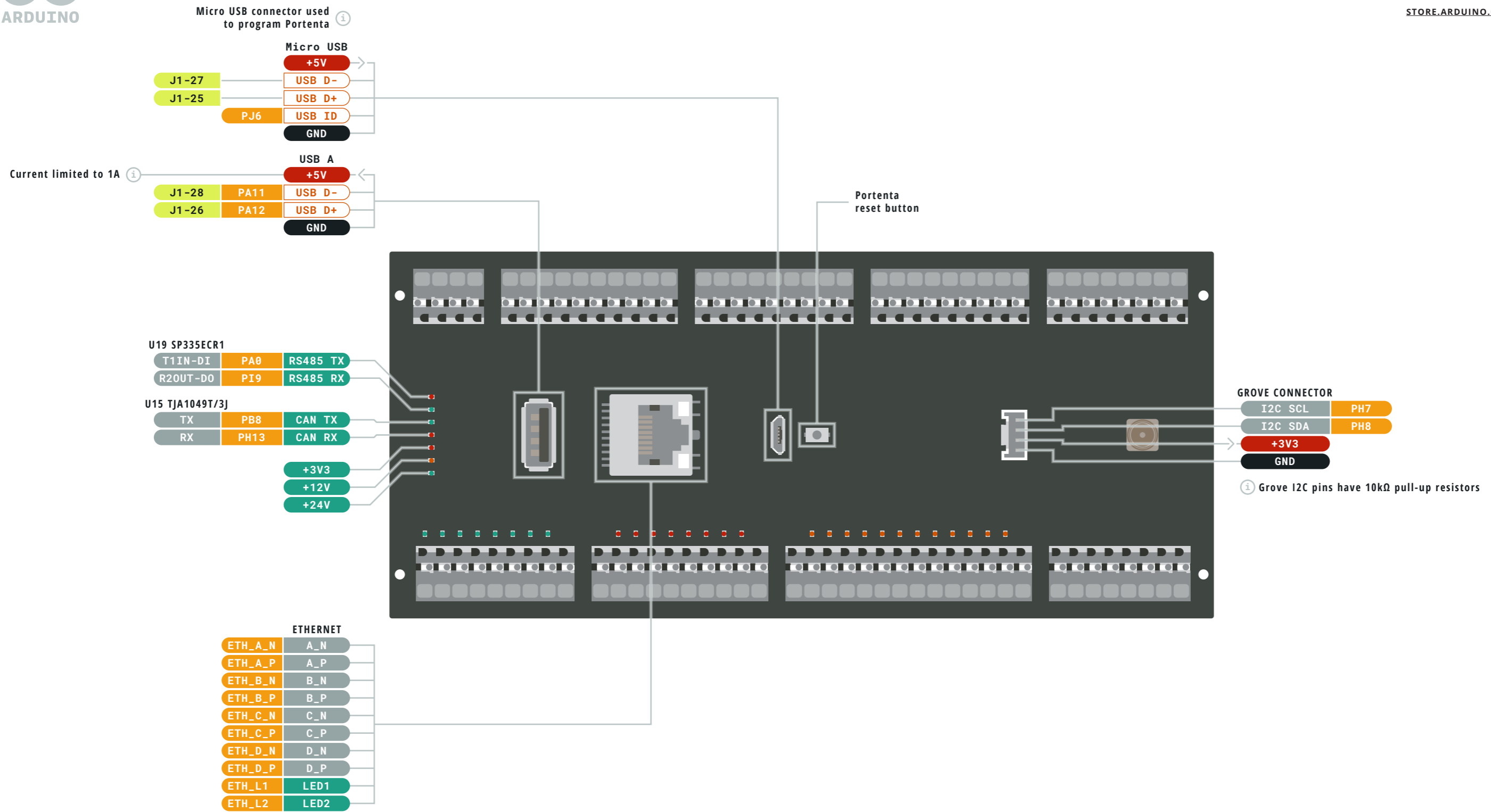

- Ground
- Power
- LED
- Internal Pin
- Microcontroller's Port
- High Density Connector

GND is common through the board



BOTTOM VIEW

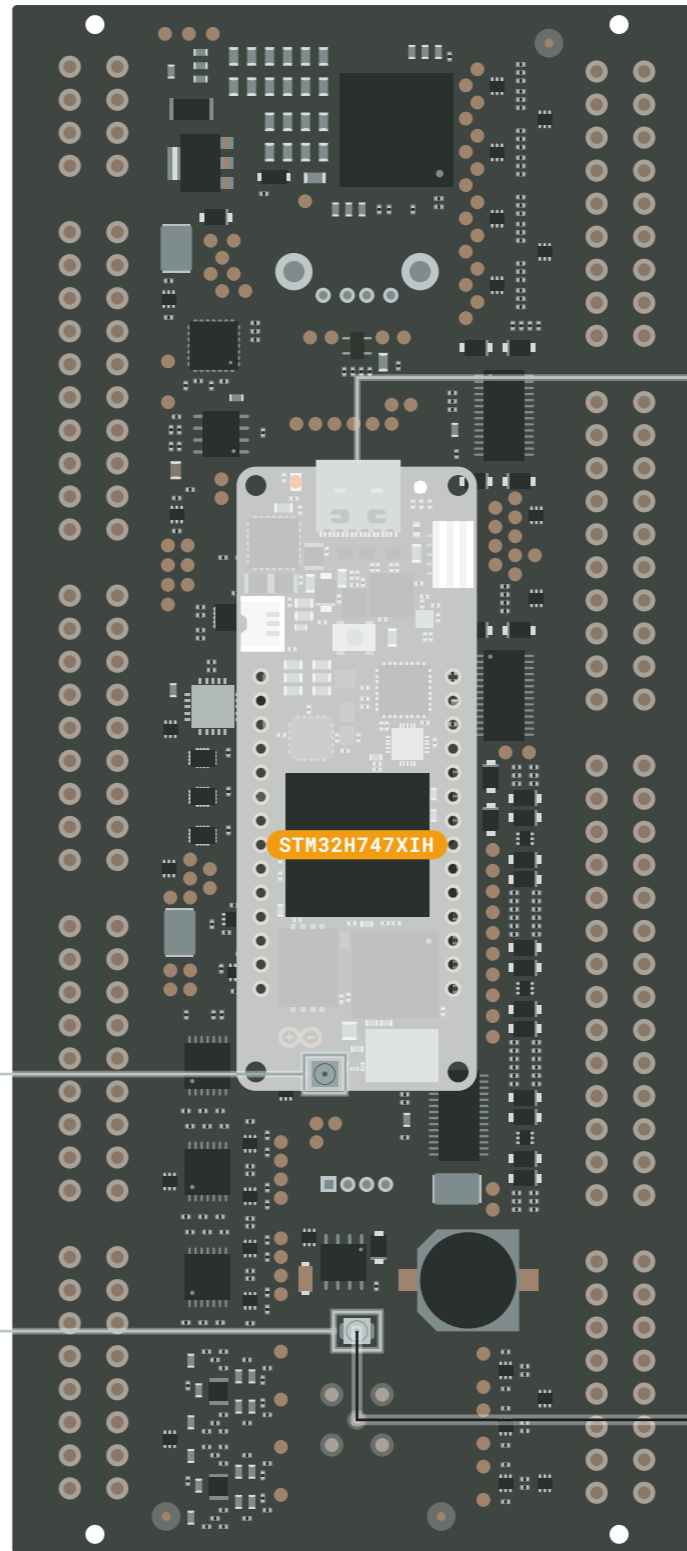

Portenta H7 Board

STM32H747XIH

Micro UFL connectors on Portenta H7 and on Portenta Machine Control need to be connected. The cable is already provided and plugged.

SMA connector for WiFi/BLE antenna

SMA connector is connected to on board Micro UFL connector

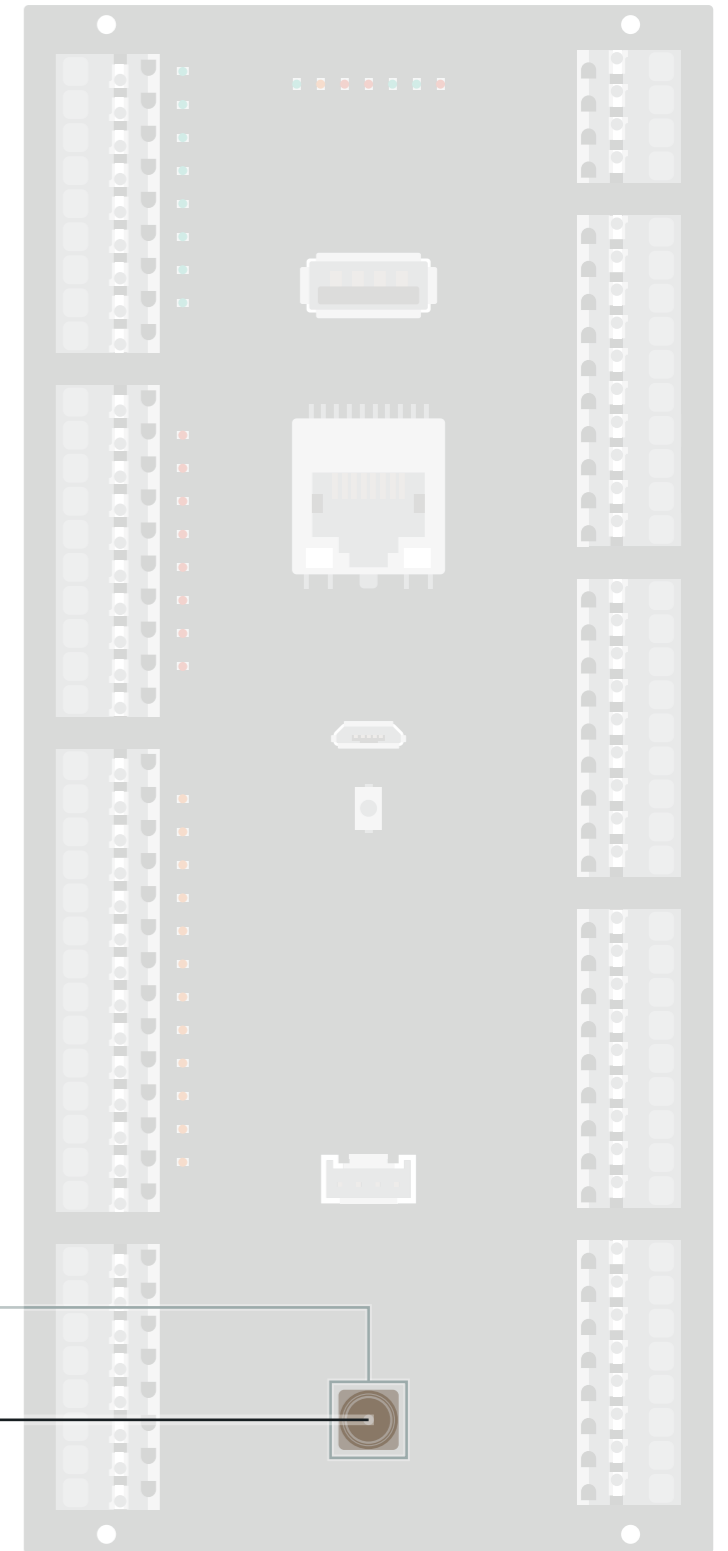

- Ground
- Power
- LED
- Internal Pin
- Microcontroller's Port
- High Density Connector

GND is common through the board



BOTTOM VIEW

Functionality: RS232	Functionality: RS485 half duplex	Functionality: RS485 full duplex
TX	B/Z	Z
	A/Y	Y
		B
RX		A

120Ω termination resistors are integrated and can be connected/disconnected via FW configuration

RS485-RS232		
U19 SP335ECR1		
Pin Name		
RS485 TX N	T1OUT, B/Z	3
RS485 TX P	T2OUT, A/Y	4
RS485 RX N	R1IN, B	19
RS485 RX P	R2IN, A	18
PA0	T1IN-DI	
PI13	T2IN-DE	
PI10	RE	
PI9	R2OUT-D0	
PA9	HALF-FULL	
PA10	RS485-RS232	
PG14	SLEW	
PI15	FD_TX_TERM	
PI14	TERM	
PG9	SHDN	

CAN		
U15 TJA1049T/3J		
Pin Name		
CAN TX	PB8	TX
CAN RX	PH13	RX
Pin Name	PA13	STB
CAN RX		CANL
CAN TX		CANH

USB POWER SWITCH		
U24 NCP383LMUAJAATXG		
Pin Name		
PB14	EN1	
PB15	FLAG	

DIGITAL INPUTS		
IO EXPANDER		
U25 TCA6424ARGJR		
		Pin Name
SDA	PH8	
SCL	PH7	
P05		01
P04		02
P02		03
P01		04
P00		05
P07		06
P06		07
P10		08
INT	PB4	

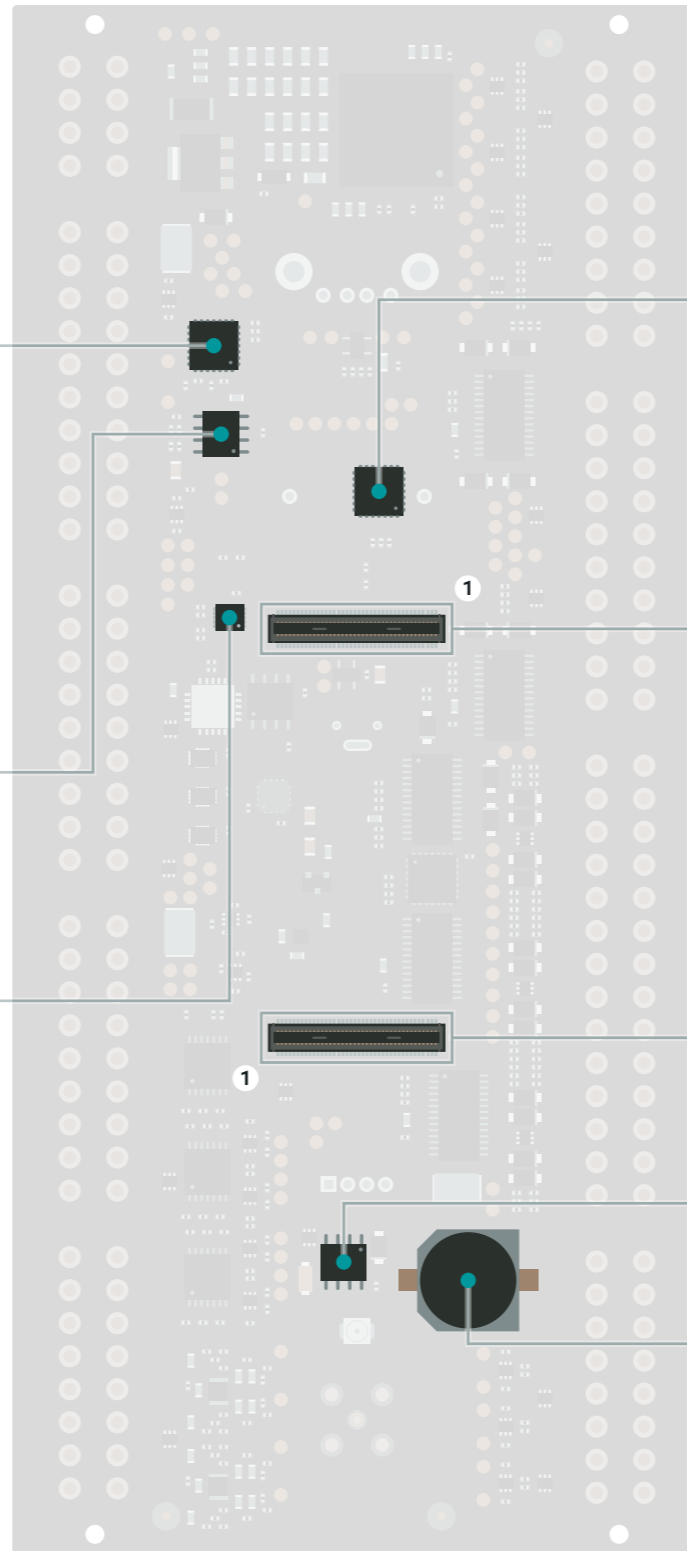

J1-Female

J2-Female

RTC		
U18 PCF8563T		
SDA	PB7	
SCL	PB6	
INT	PB9	

RTC SUPERCAP
100mF, FCOV104ZFTBR24

- Ground
- Power
- LED
- Internal Pin
- Microcontroller's Port
- High Density Connector

GND is common through the board



BOTTOM VIEW

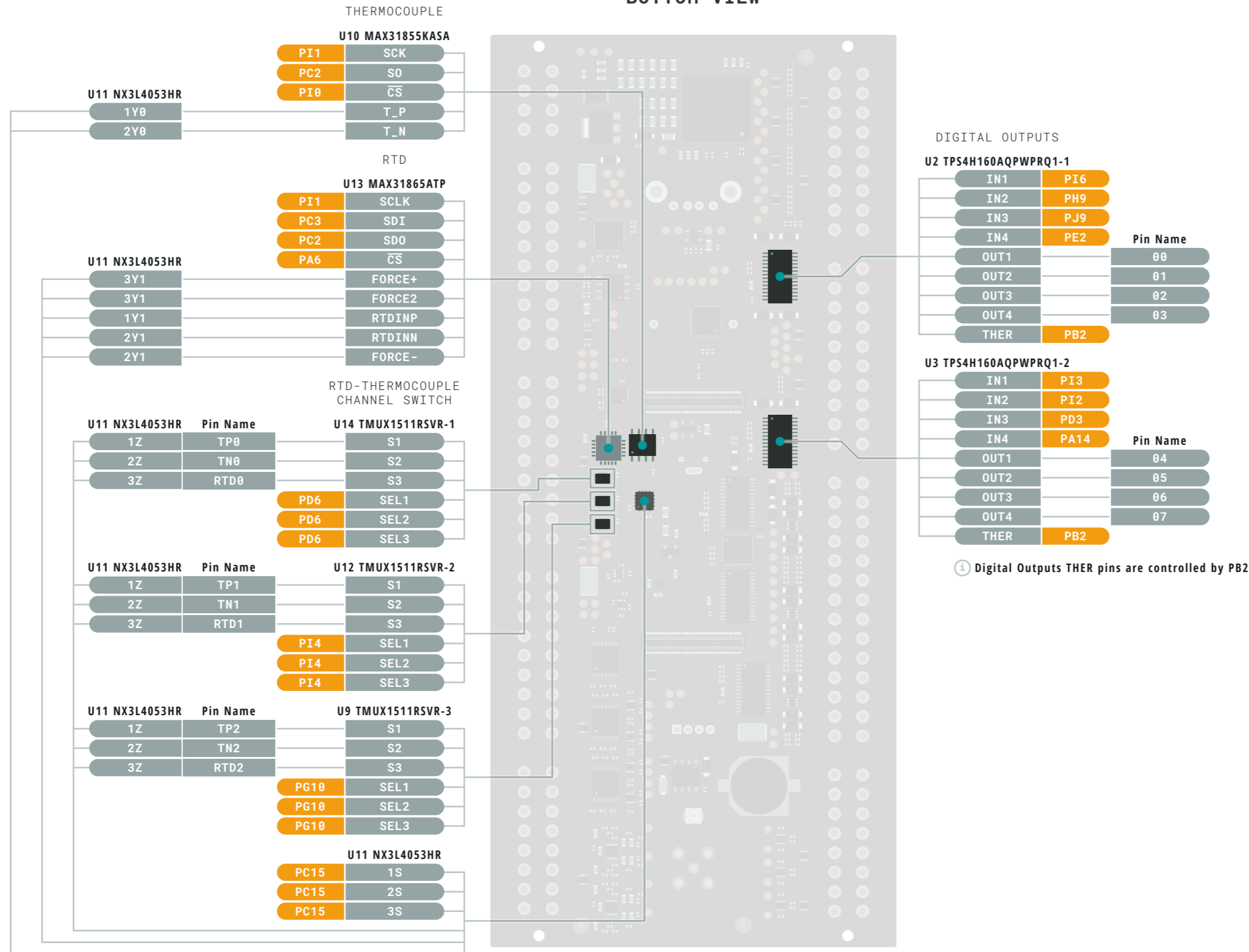

Digital Outputs THER pins are controlled by PB2

- Ground
- Power
- LED
- Internal Pin
- Microcontroller's Port
- High Density Connector

GND is common through the board



BOTTOM VIEW

PROGRAMMABLE DIGITAL I/O

STORE.ARDUINO.CC/MACHINE-CONTROL

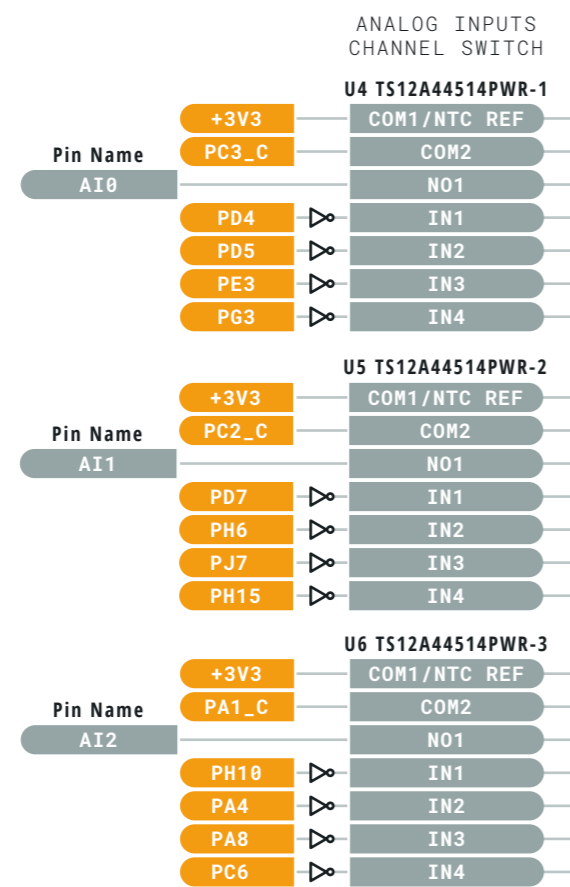

⚠ EACH PORTENTA PIN CONNECTED TO AN ANALOG INPUT IN* PIN IS INVERTED BY A TRANSISTOR

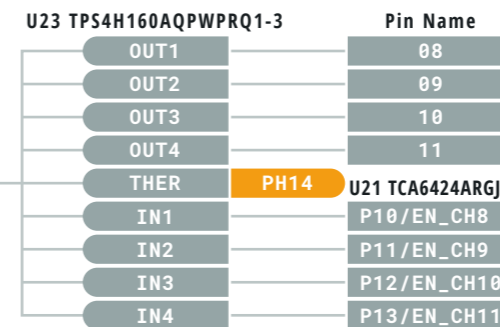
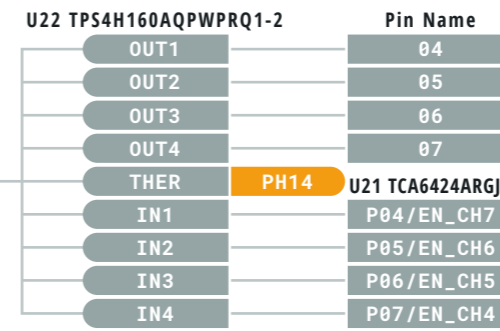
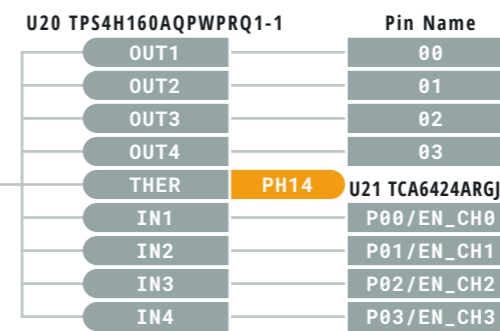
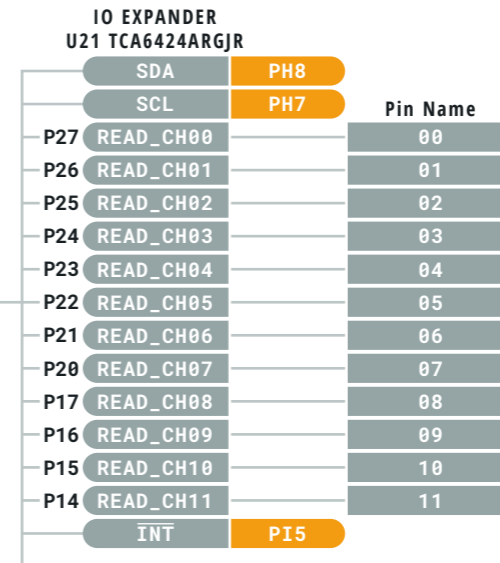
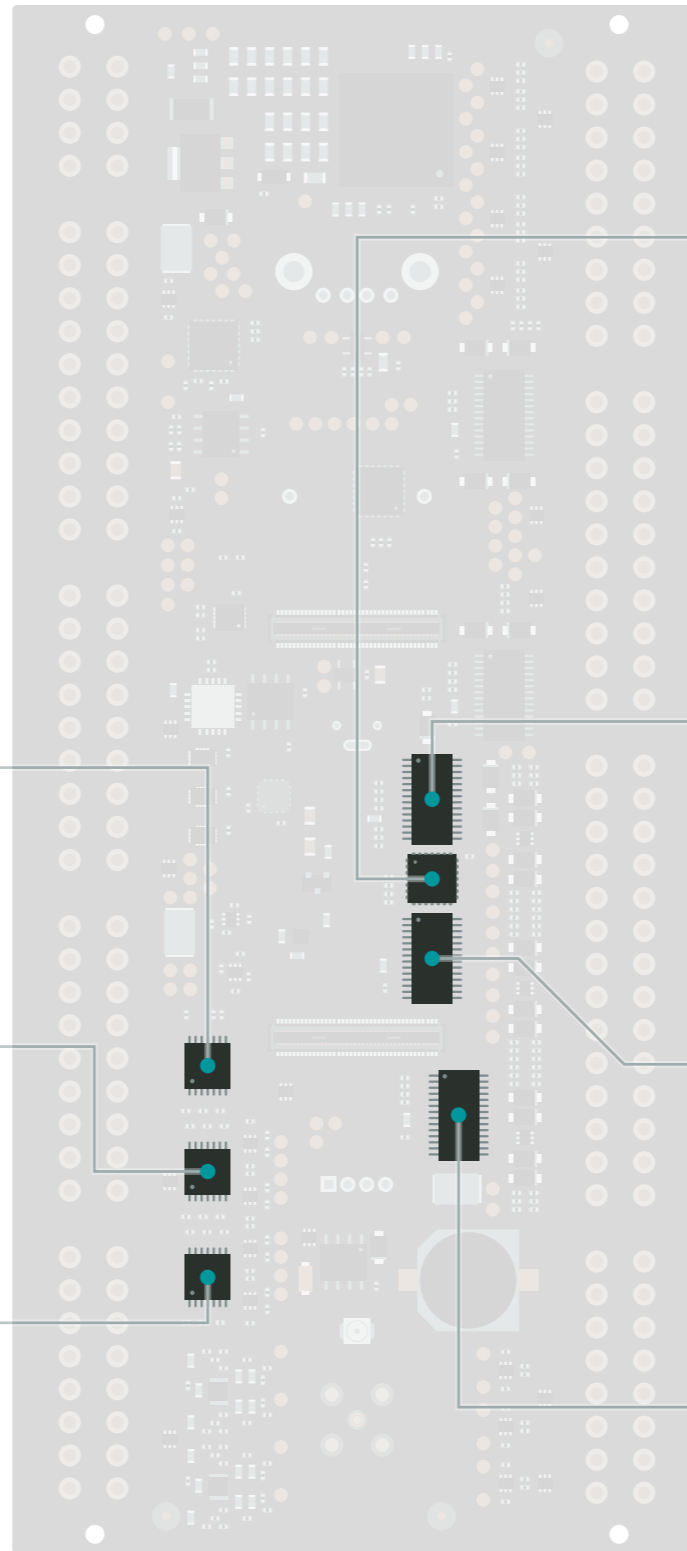

i Digital Programmable THER pins are controlled by PH14

- Ground
- Microcontroller's Port
- Power
- High Density Connector
- LED
- Internal Pin

GND is common through the board



BOTTOM VIEW

J1-Female

ETH A+	1	2
ETH A-	3	4
ETH B+	5	6
ETH B-	7	8
	9	10 DSI D1+
	11	12 DSI D1-
	13	14 DSI D0+
	15	16 DSI D0-
ETH L1	17	18 DSI CK+
ETH L2	19	20 DSI CK-
VIN	21	22 GND
USB1 VBUS	23	24
USB1 D+	25	26 USB0 D+
USB1 D-	27	28 USB0 D-
USB1 ID	29	30
GND	31	32 VIN
UART1 TX	33	34 UART0 TX
UART1 RX	35	36 UART0 RX
UART1 RTS	37	38 UART0 RTS
UART1 CTS	39	40 UART0 CTS
VIN	41	42 GND
I2C1 SDA	43	44 I2C0 SDA
I2C1 SD6	45	46 I2C0 SCL
GND	47	48 VIN
CAN1 TX	49	50
CAN1 RX	51	52
VSYS	53	54 GND
SDC CLK	55	56 I2S MCK
SDC CMD	57	58 I2S WS
SDC D0	59	60 I2S DI
SDC D1	61	62 I2S DO
SDC D2	63	64 VSYS
SDC D3	65	66 DMIC CK
	67	68 DMIC D0
	69	70
	71	72 V-SDCARD
RESET	73	74
SWDIO	75	76
SWCK	77	78
SWO	79	80

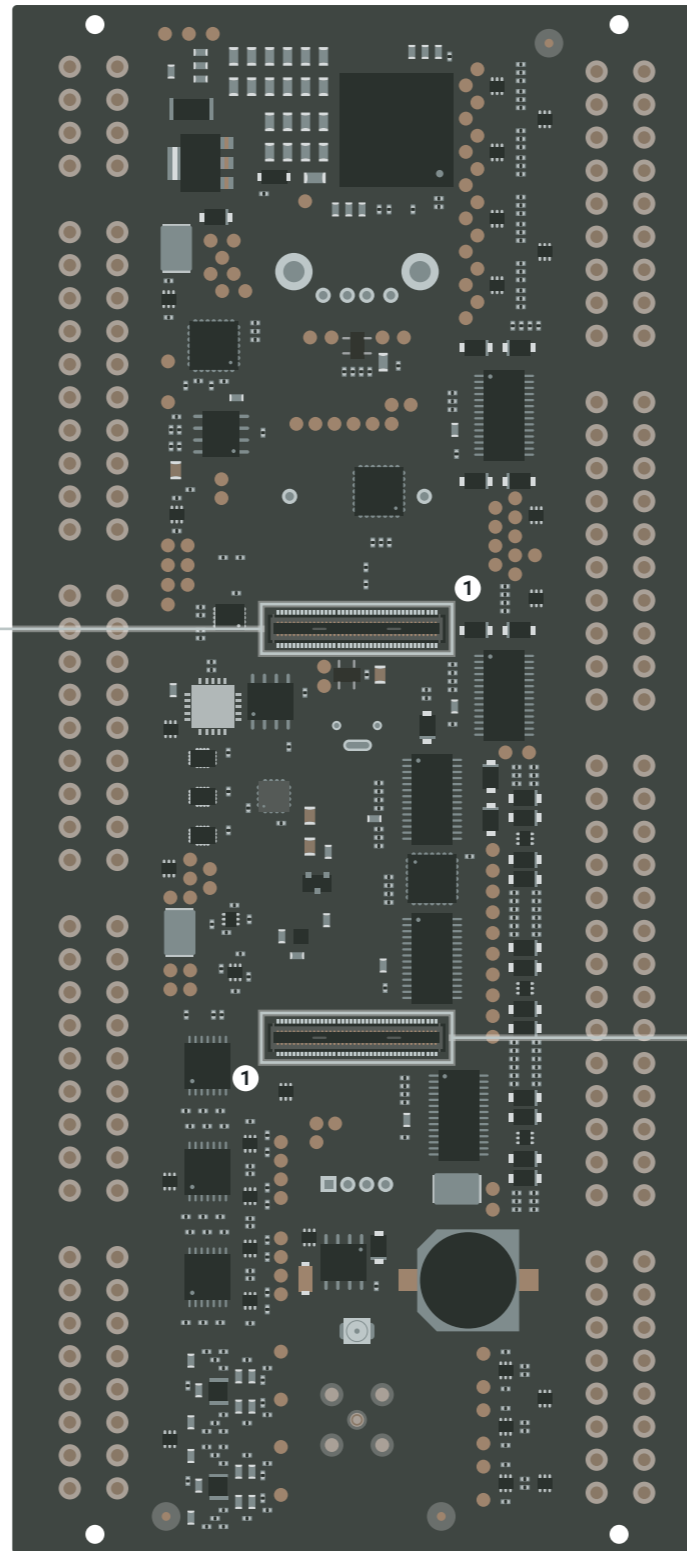

J2-Female

ADC A7	80	79 ADC A3
ADC A6	78	77 ADC A2
ADC A5	76	75 ADC A1
ADC A4	74	73 ADC A0
ADC VREF-	72	71 ADC VREF+
GND	70	69 VCC/+3V3
PWM 10	68	67 PWM 5
PWM 9	66	65 PWM 4
PWM 8	64	63 PWM 3
PWM 7	62	61 PWM 2
PWM 6	60	59 PWM 1
GPIO 6	58	57 GND
GPIO 5	56	55
GPIO 4	54	53 SAI D0
GPIO 3	52	51 SAI FS
GPIO 2	50	49 SAI CK
GPIO 1	48	47 I2C2 SCL
GPIO 0	46	45 I2C2 SDA
GND	44	43 VCC/+3V3
SPI1 COPI	42	41
SPI1 CIPO	40	39
SPI1 CK	38	37
SPI1 CS	36	35
VCC	34	33 GND
	32	31
	30	29
UART2 RX	28	27 UART3 RX
UART2 TX	26	25 UART3 TX
GND	24	23 VCC/+3V3
CAM HS	22	21
CAM CLK	20	19
CAM VS	18	17
CAM D0	16	15
CAM D1	14	13
CAM D2	12	11
CAM D3	10	9
CAM D4	8	7 COINCELL
CAM D5	6	5 POWER_ON_REQ
CAM D6	4	3 BOOT_SOURCE
CAM D7	2	1 FORCE_BOOTLOADER

- Ground
- Power
- LED
- Internal Pin
- Microcontroller's Port
- High Density Connector

GND is common through the board

