

6 x 6mm Tactile Switches



DESCRIPTION

A miniature through-hole mounting tactile switch.

DISTINCTIVE FEATURES

- Positive switch action
- Normally open single pole contacts
- Four terminal mounting for additional stability

APPLICATIONS

Suitable for general purpose use.

6 x 6
mm

SPST

5mm



ELECTRICAL SPECIFICATION

Current max.	500mA
Contact configuration	SPST (NO)
Action	Off/(on)



GENERAL SPECIFICATION

Type	Tactile switch
------	----------------



MATERIALS

Housing	PBT
Button	PBT
Cover	Nickel-plated Brass
Contact	Gold-plated Brass



TERMINALS

Type	Kinked Pin
PCB Hole Size	1mm



DIMENSIONS/DRAWINGS

Dimensions	mm
Button height (H)	5mm

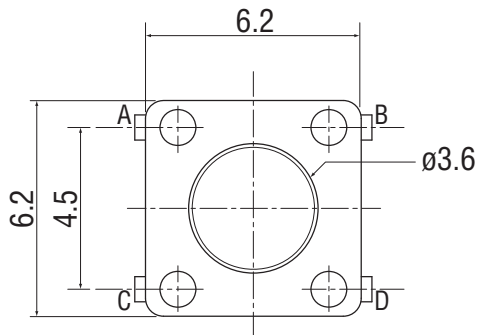

PCB LAYOUT TOP VIEW

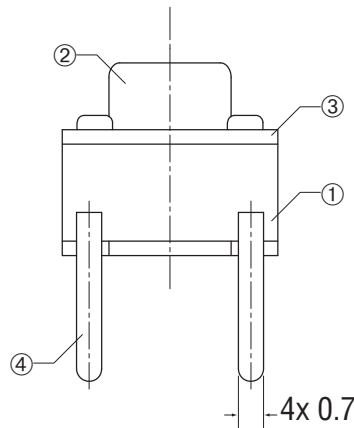
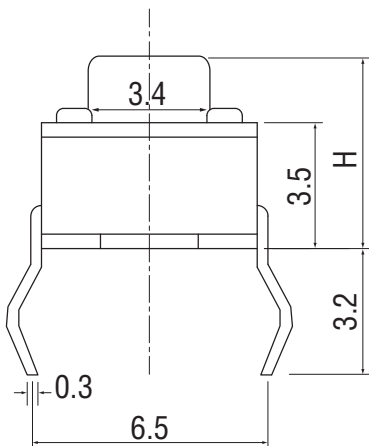
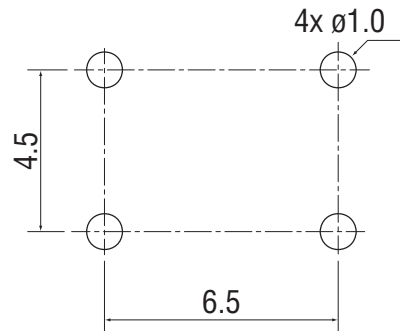

SCHEMATIC

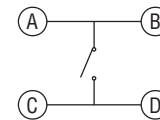

PART NUMBER TABLE

Part Number	EAN	UNSPSC	Country of Origin
78-3861	5053556001484	39122216	China

R-TECH

Tried & trusted technology

Important Notice: This data sheet and its contents (the "Information") belong to Rapid Electronics Limited or are licensed to it. No licence is granted for the use of it other than for information purposes in connection with the products to which it relates. No licence of any intellectual property rights is granted. The Information is subject to change without notice and replaces all data sheets previously supplied. The Information supplied is believed to be accurate but Rapid Electronics Limited assumes no responsibility for its accuracy or completeness, any error in or omission from it or for any use made of it. Users of this data sheet should check for themselves the Information and the suitability of the products for their purpose and not make any assumptions based on information included or omitted. Liability for loss or damage resulting from any reliance on the Information or use of it (including liability resulting from negligence or where Rapid Electronics Limited were aware of the possibility of such loss or damage arising) is excluded. This will not operate to limit or restrict Rapid Electronics Limited's liability for death or personal injury resulting from its negligence.