

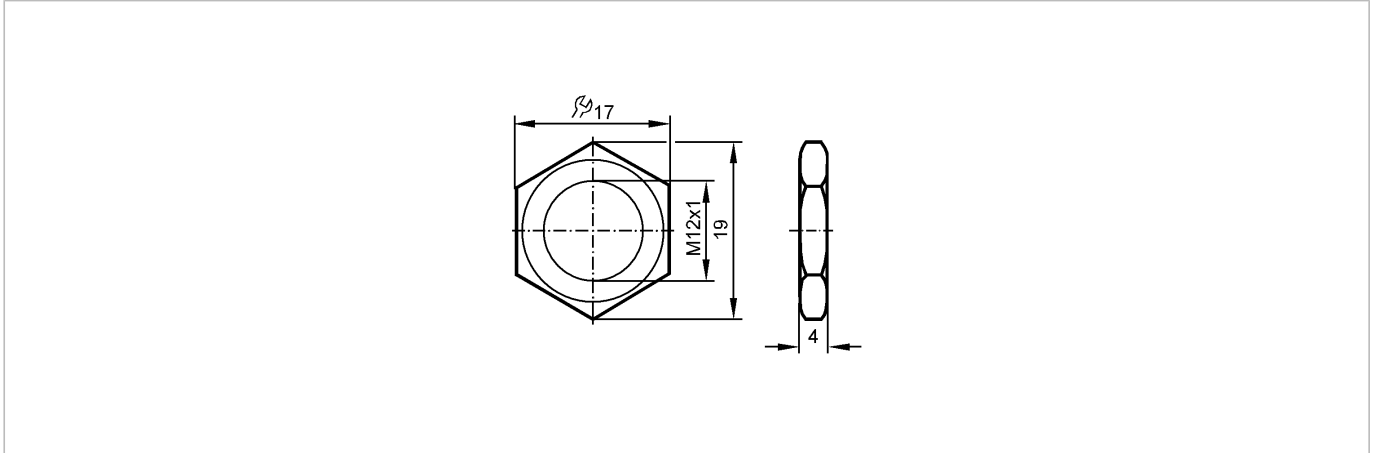

NUT M12X1 V4A 2 PIECES

Accessories



Product characteristics

Lock nuts metal

M12 x 1

Mechanical data

Housing materials

stainless steel 316Ti / 1.4571

Weight

[kg]

0.011

Remarks

Pack quantity

[piece]

2