

Ordering number C12095_MINNIE-M

Family	Minnie	FWHM	26 degrees
Type	Reflector	Efficiency	92 %
LED	MT-G	cd/lm	-
Color	Metal	Gerber File	Available
Diameter	32.4 mm		
Height	14.75 mm		
Style	Round		
Optic Material	PC		
Holder Material	-		
Fastening	Glue		
Status	Ready		

Version without holder, correct mounting height from the PCB 1

Ordering number C11862_MINNIE-W

Family	Minnie	FWHM	36 degrees
Type	Reflector	Efficiency	92 %
LED	MT-G	cd/lm	-
Color	Metal	Gerber File	Available
Diameter	32.4 mm		
Height	14.75 mm		
Style	Round		
Optic Material	PC		
Holder Material	-		
Fastening	Glue		
Status	Ready		

Version without holder, correct mounting height from the PCB 1

Ordering number C12097_MINNIE-WWW

Family	Minnie	FWHM	74 degrees
Type	Reflector	Efficiency	90 %
LED	MT-G	cd/lm	-
Color	Metal	Gerber File	Available
Diameter	32.4 mm		
Height	14.75 mm		
Style	Round		
Optic Material	PC		
Holder Material	-		
Fastening	Glue		
Status	Ready		

Version without holder, correct mounting height from the PCB 1

NOTE: The typical divergence will be changed by different color, chip size and chip position tolerance. The typical total divergence is the full angle measured where the luminous intensity is half of the peak value.



PRODUCT DATASHEET

Minnie series

last update 13/6/2013

GENERAL INFORMATION

- Product series especially designed & optimized for MT-G series of LEDs.
- Special care taken to make light distribution as uniform as possible.
- Reflector is made of aluminium coated PC (120 degrees of Celcius / 248 degrees of Fahrenheit) with protective lacquer (110 degrees of Celcius / 230 degrees of Fahrenheit).
- Fastening to PCB with appropriate adhesive. By clicking link below you can find Ledil recommended glue options.
http://www.ledil.com/datasheets/DataSheet_GLUES.pdf

NOTE 1: We advise customer to ensure the suitability and sufficiency of the bond in the end product. For example, mechanical stress, vibration and holes on the surface of the circuit board weaken the strength of the glue.

NOTE 2: All surfaces where glue is applied must be clean, dry and free from grease and dirt. If cleaning of PCB surfaces is needed, please follow strictly the cleaning instructions of your LED manufacturer -this is important as cleaning shall under no circumstances damage LEDs or other electronics components on the PCB.

Further note that optical components shall not be cleaned with any chemicals - only micro fiber cloth may be used to remove fingerprints or other traces from handling.

Relative intensity of C12095_MINNIE-M / CA12239_MINNIE-M

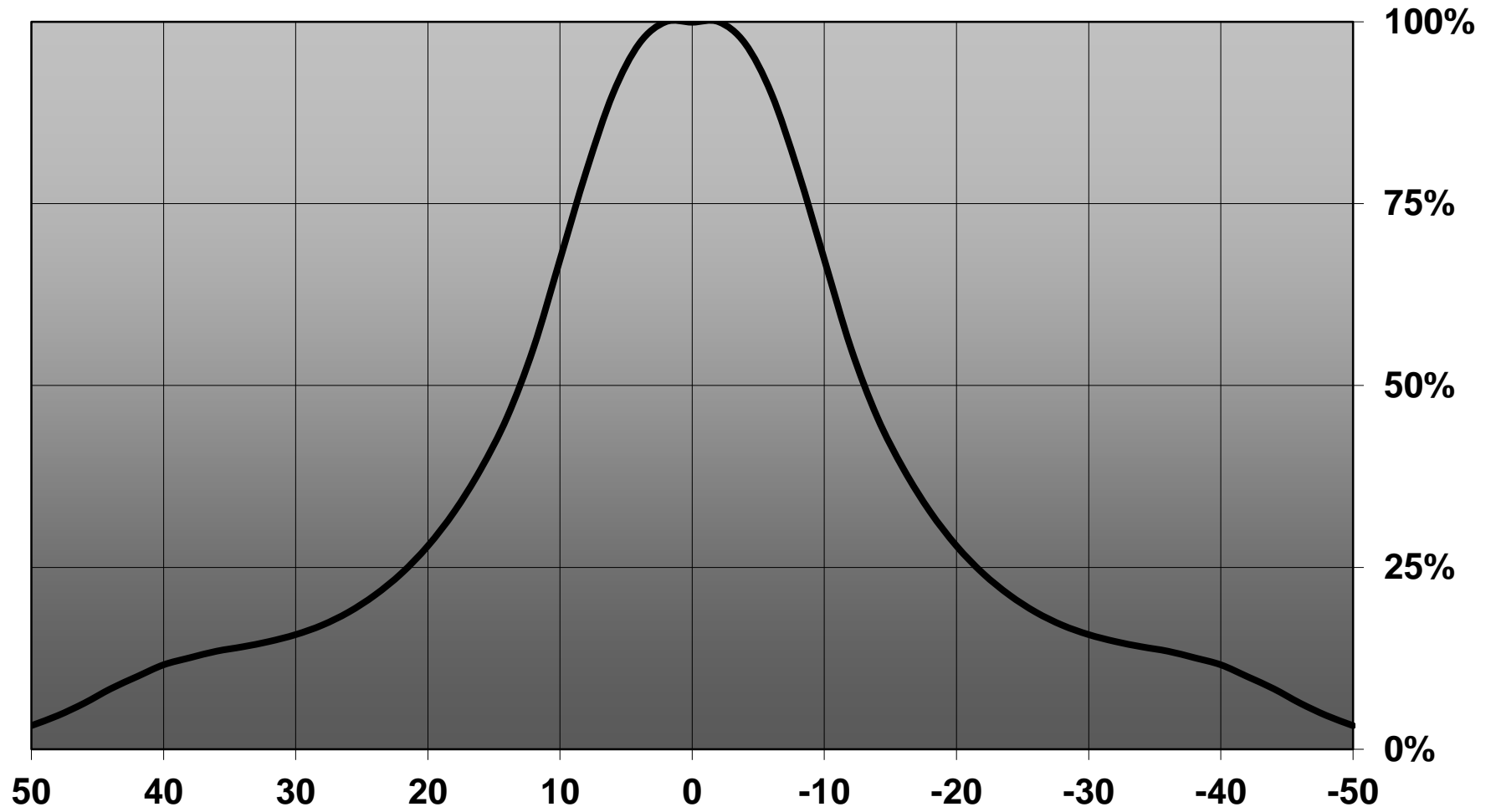

Relative intensity of Minnie-W-MTG

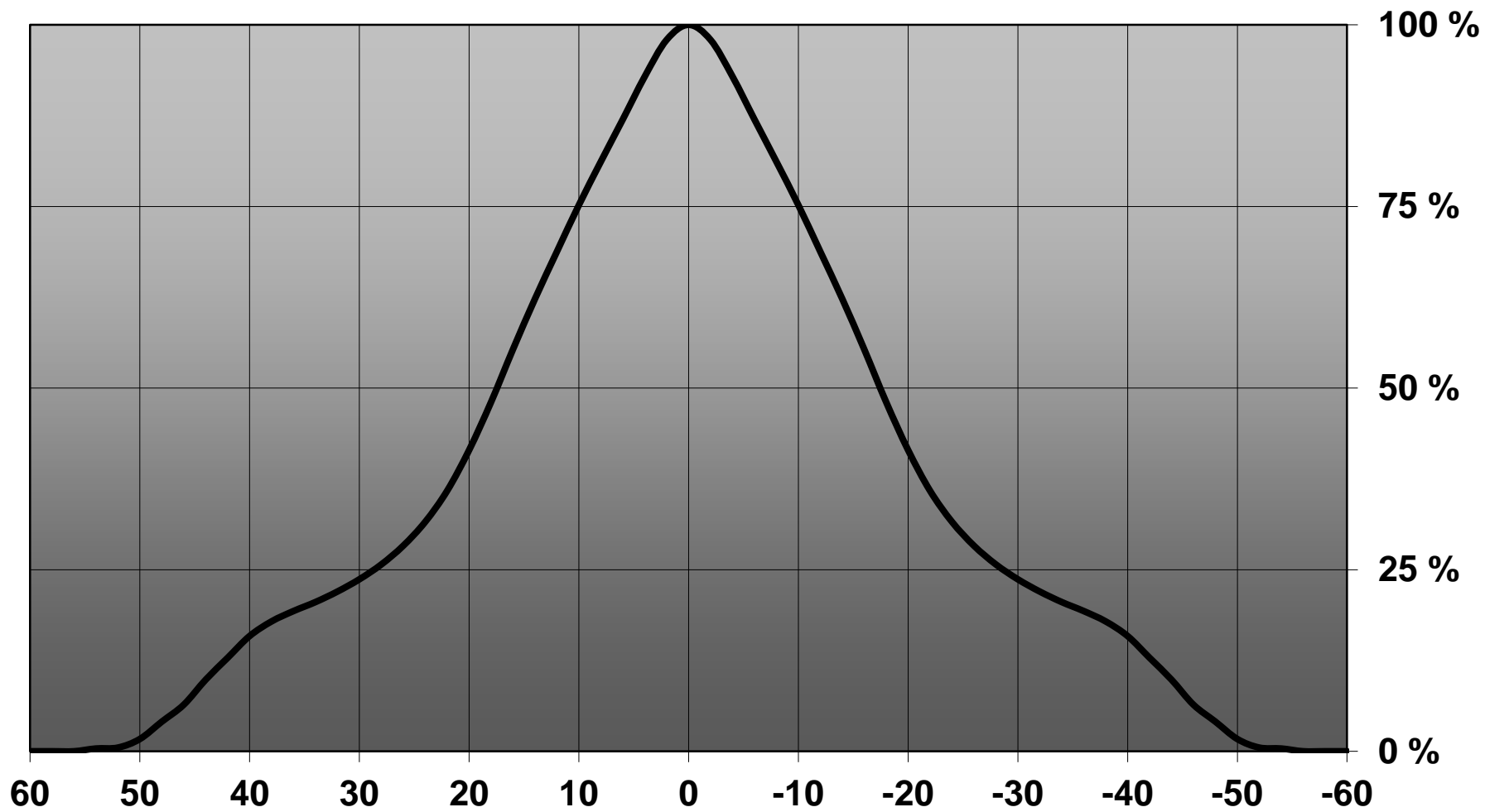

Relative intensity of CA12240_Minnie-WWW-MTG-assy

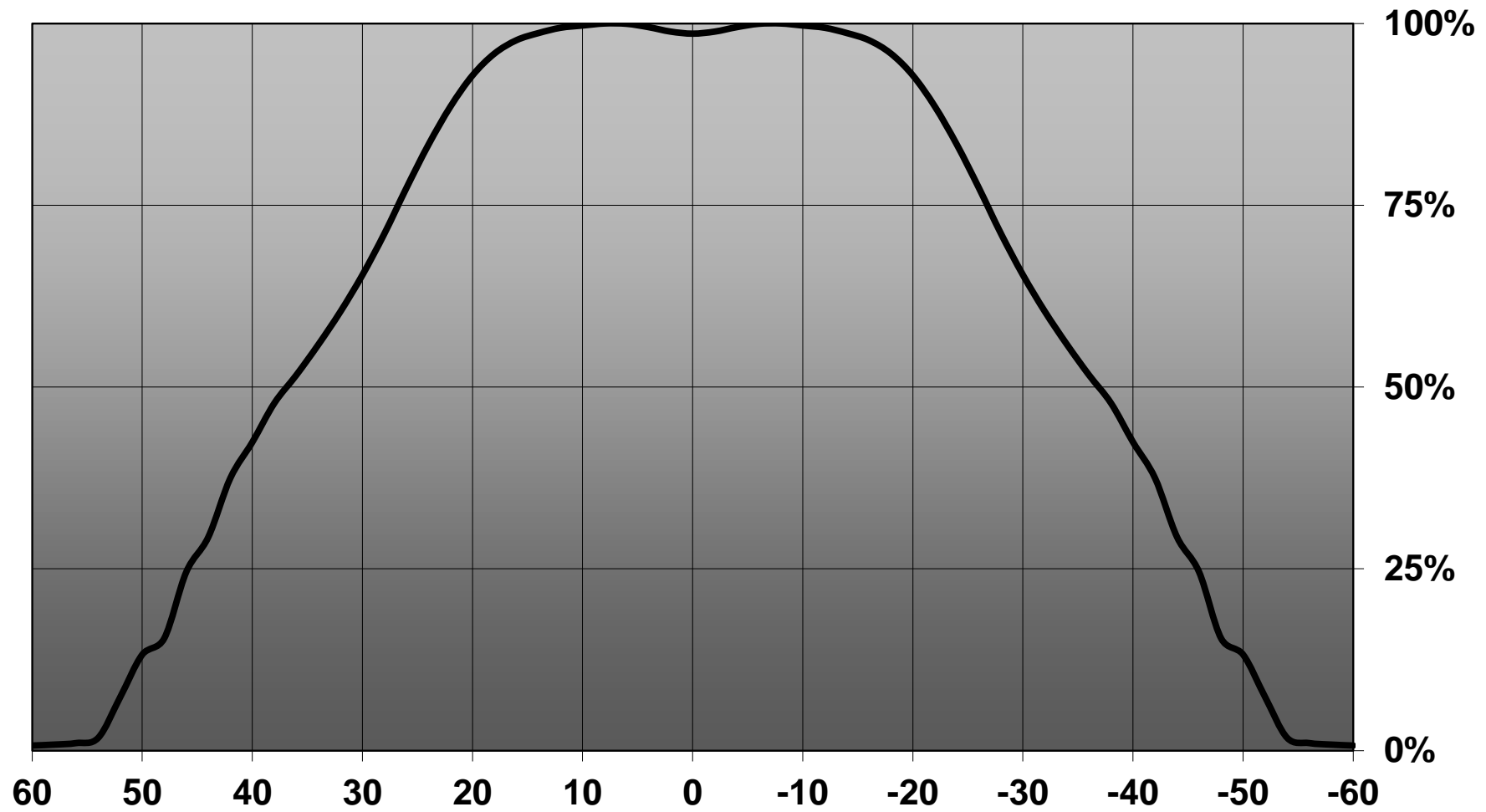

D

C

B

A

4

4

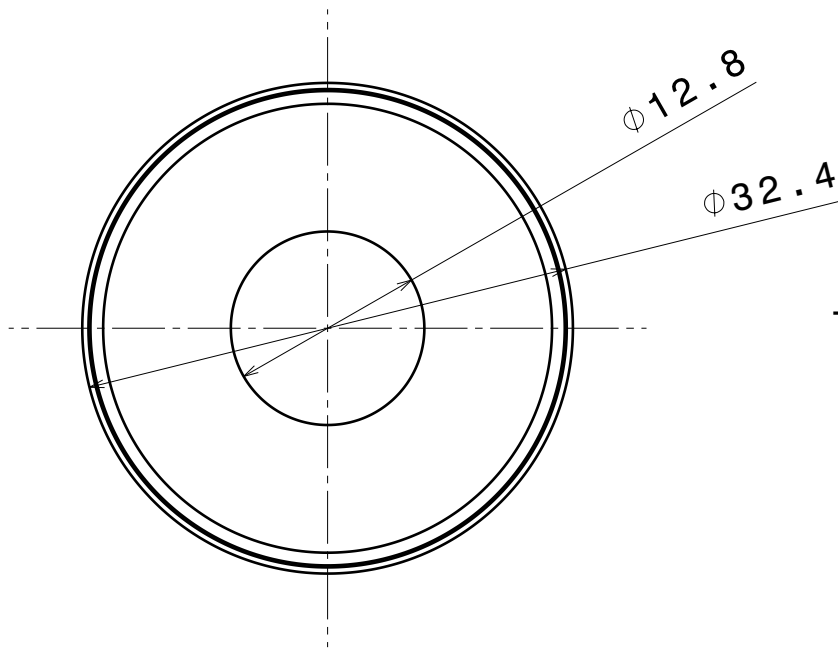

Top view

3

3

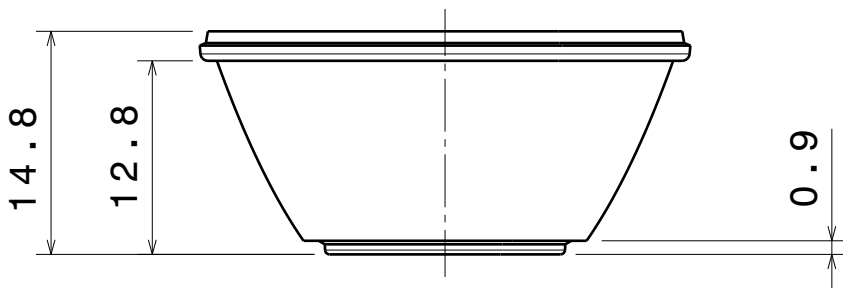

Front view

2

2

Version without holder,
correct mounting height from the PCB 1,0 mm

Tolerances if not otherwise shown
According to DIN ISO 2768-1
Linear measures:
Up to 30mm class F, otherwise class M.
According to DIN ISO 2768-2
Form and position: class K

LEDiL LediL Oy
Salorankatu 10
FIN 24240 SALO
Finland

THIRD ANGLE PROJECTION:

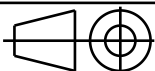

DRAWING TITLE

Datasheet Minnie

This drawing is the property
of LEDiL Oy. It may not be
reproduced, copied or
communicated without a written
agreement with LEDiL Oy."

SIZE PART NUMBER

A4

-

SCALE

2:1

WEIGHT

(g)

SHEET

1/1

D

A

1

1

Ledil Oy CA12239_Minnie-M-MTG / LDC (Linear)

Luminaire: Ledil Oy CA12239_Minnie-M-MTG
Lamps: 1 x Cree MT-G 745lm 250mA

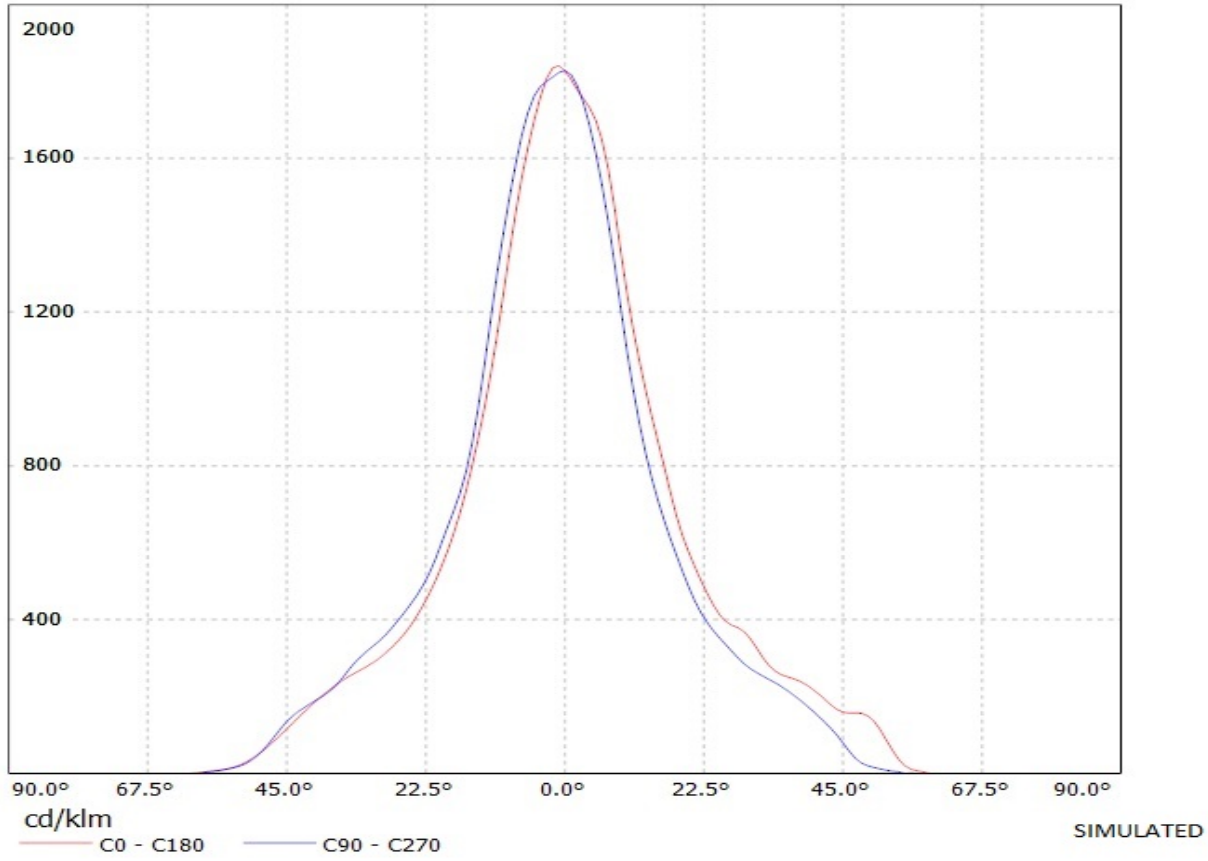

Luminaire: Ledil Oy C12097_Minnie-WWW-MTG C12097_Minnie-WWW-MTG
Lamps: 1 x Cree MT-G 36V 745lm 250m

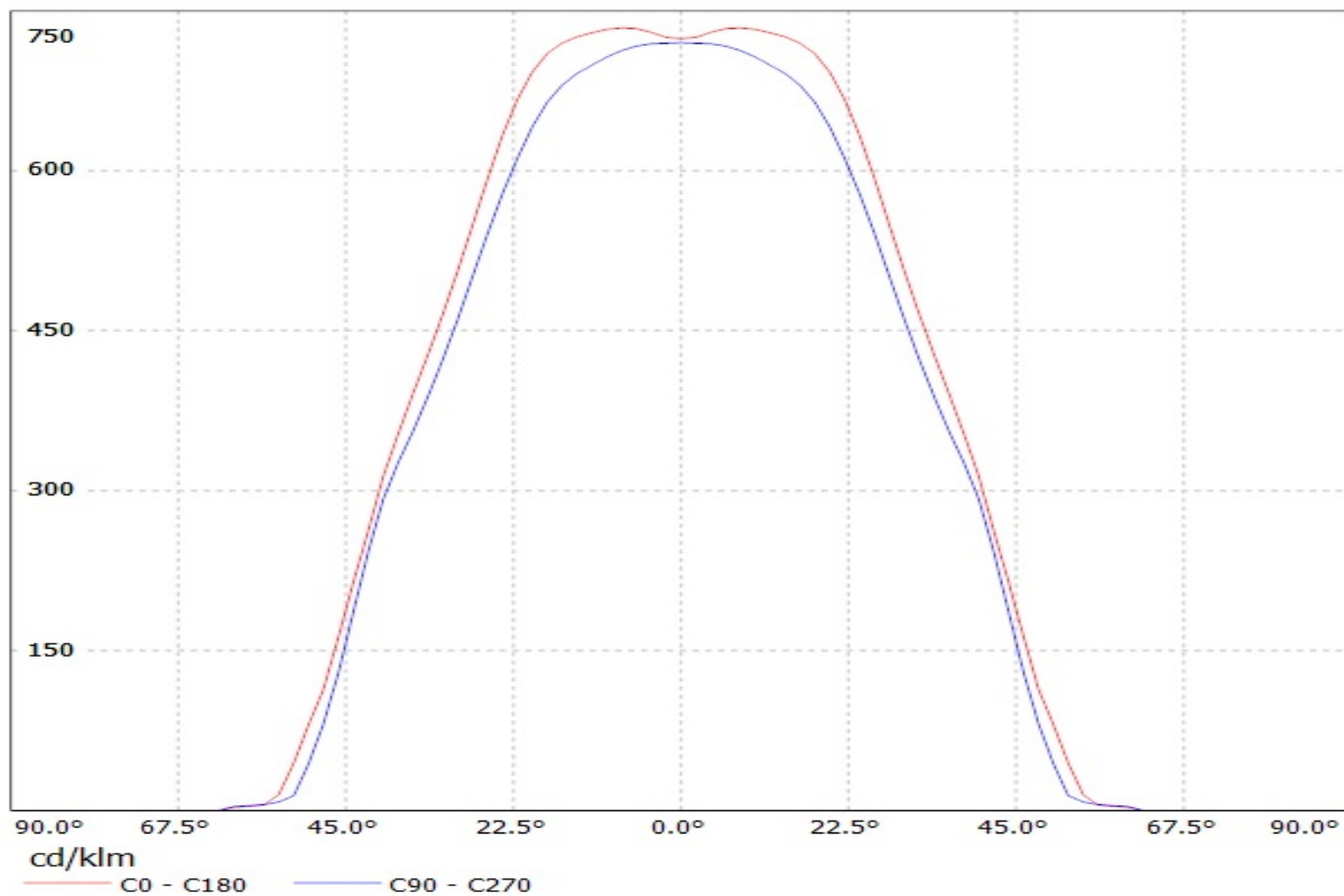

Luminaire: Ledil Oy CA12239_Minnie-M-MTG
Lamps: 1 x Cree MT-G 745lm 250mA

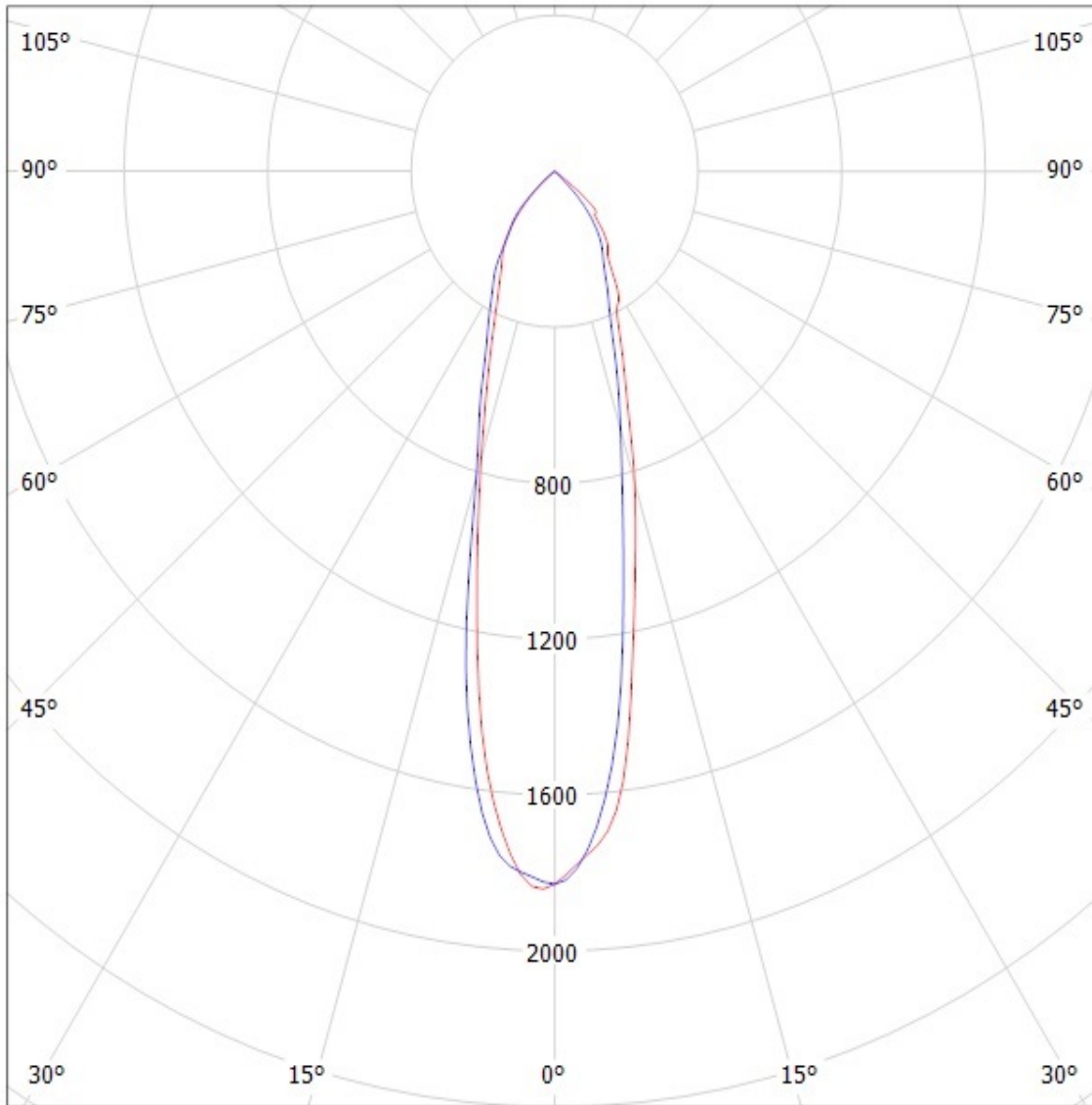

cd/klm

— C0 - C180 — C90 - C270

SIMULATED

Luminaire: Ledil Oy C12097_Minnie-WWW-MTG C12097_Minnie-WWW-MTG
Lamps: 1 x Cree MT-G 36V 745lm 250m

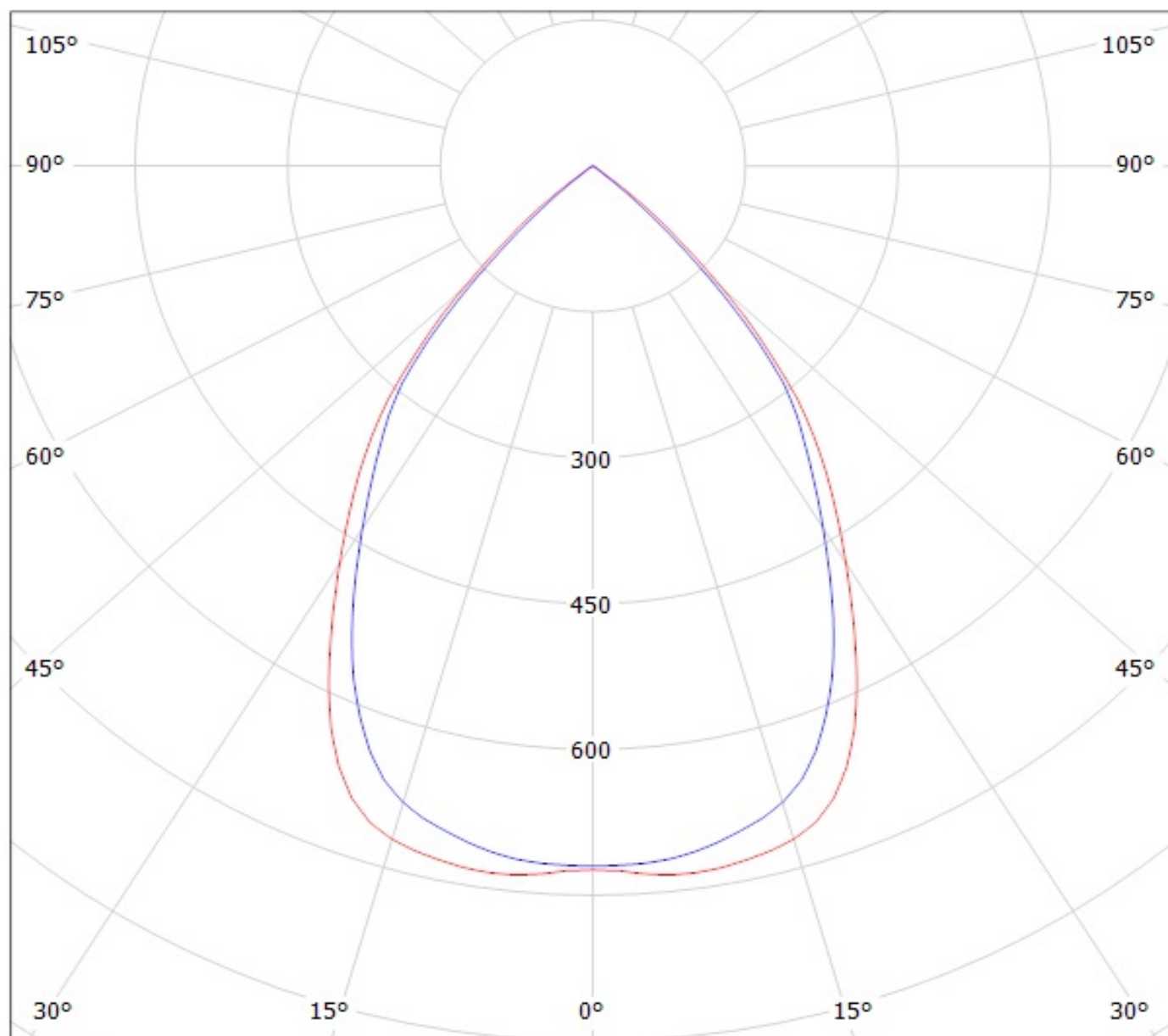

cd/klm

— C0 - C180

— C90 - C270