



## I2C isolator click™



### 1. Introduction

I2C Isolator click™ carries **ISO1540**, a **low-power, bidirectional isolator compatible with I<sup>2</sup>C interfaces**. On the board, the Texas Instruments chip is connected to two sets of I<sup>2</sup>C pins, one on the **mikroBUS™** connector [SDA, SCL], the other on the upper edge of the board [SCL2, SDL2]. ISO1540 uses a silicon dioxide barrier that separates the logic input and output buffers. The board can use either 3.3V or 5V power supplies.

### 2. Soldering the headers

Before using your click™ board, make sure to solder 1x8 male headers to both left and right side of the board. Two 1x8 male headers are included with the board in the package.

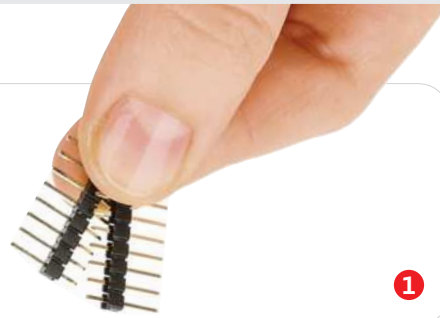

Turn the board upside down so that the bottom side is facing you upwards. Place shorter pins of the header into the appropriate soldering pads.

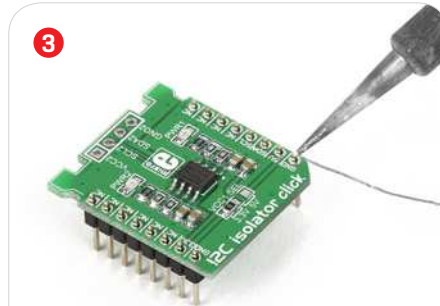

Turn the board upward again. Make sure to align the headers so that they are perpendicular to the board, then solder the pins carefully.

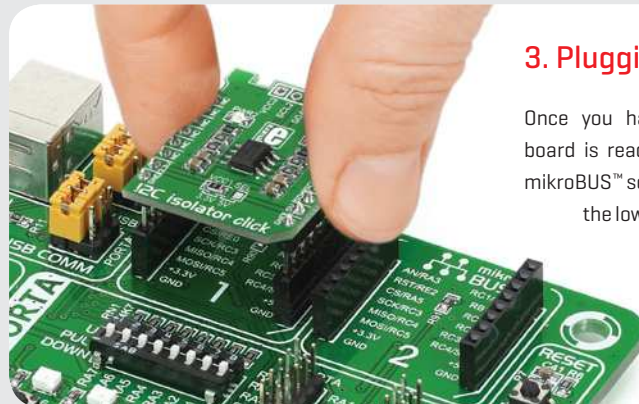

### 3. Plugging the board in

Once you have soldered the headers your board is ready to be placed into the desired mikroBUS™ socket. Make sure to align the cut in the lower-right part of the board with the markings on the silkscreen at the mikroBUS™ socket. If all the pins are aligned correctly, push the board all the way into the socket.

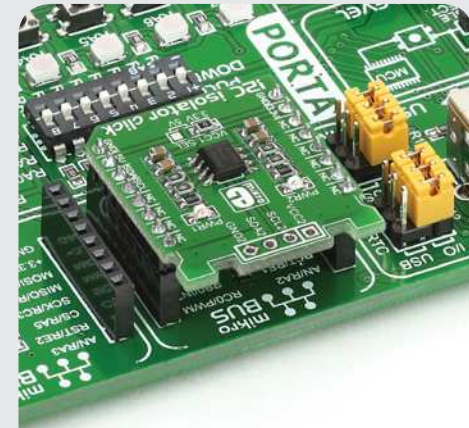

### 4. Essential features

Bidirectional isolators based on **TI's Capacitive Isolation technology** have many advantages over opto-couplers (performance, size, power consumption etc.). When used together with isolated power supplies, they block high voltages, isolate grounds, and prevent interference from noise currents. Since ISO1540 provides two isolated **bidirectional channels for clock and data lines**, it's suitable for use in applications that have multiple masters.

**click™**  
**BOARD**  
[www.mikroe.com](http://www.mikroe.com)



I2C isolator click™ manual  
ver 1.00



010000076965

## 5. Schematic

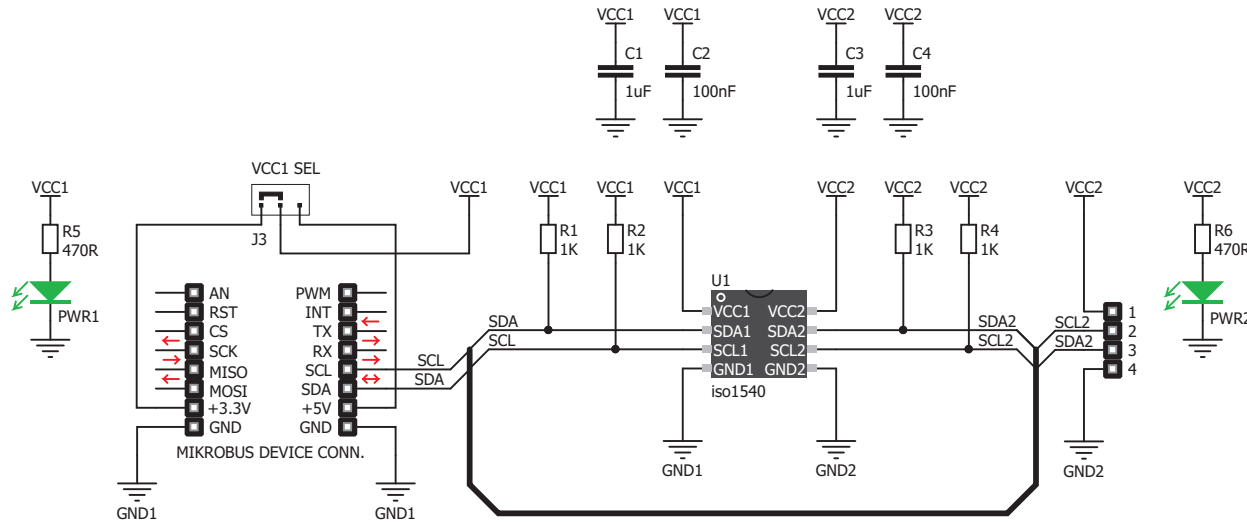

## 6. Dimensions

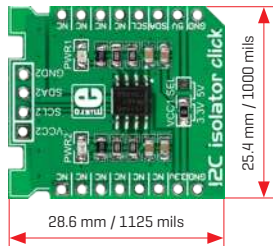

	mm	mils
LENGTH	28.6	1125
WIDTH	25.4	1000
HEIGHT*	3.3	130

\* without headers

## 7. The VCC1 SEL jumper

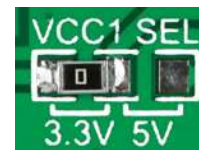

There is one zero-ohm SMD jumper used to select whether **3.3V or 5V VCC1** levels are used. The jumper is soldered in 3.3V position by default.

## 8. Code examples

Once you have done all the necessary preparations, it's time to get your click™ board up and running. We have provided examples for mikroC™, mikroBasic™ and mikroPascal™ compilers on our **Libstock** website. Just download them and you are ready to start.



## 9. Support

MikroElektronika offers **free tech support** [[www.mikroe.com/support](http://www.mikroe.com/support)] until the end of the product's lifetime, so if something goes wrong, we're ready and willing to help!



## 10. Disclaimer

MikroElektronika assumes no responsibility or liability for any errors or inaccuracies that may appear in the present document. Specification and information contained in the present schematic are subject to change at any time without notice.

Copyright © 2015 MikroElektronika.  
All rights reserved.