

### 3000 Watts

- High efficiency up to 92%
- High power density
- DC outputs from 150-400VDC
- Programmable output voltage (0-105%)
- Programmable output current (0-105%)
- I<sup>2</sup>C, RS485 & RS232 interfaces
- Parallel operation
- Fully featured signals & controls
- 3 year warranty



#### Dimensions:

##### HDL3000:

6.69 x 2.52 x 11.87" (170.0 x 64.0 x 301.49 mm)  
including connectors

The HDL3000HV series offers users both output voltage and output current programming (0 – 105%) via resistance, voltage or digital bus in a very high efficiency, high power density 3 kW chassis mount package. Measuring just 6.69" x 2.52" x 11.02", the HDL3000 also features active current sharing, built-in ORing diode, remote on/off and a power OK signal. The standby output is available whenever the mains supply is present and can be user selected as either 5 V at 0.5 A or 9V at 0.3 A.

### Models & Ratings

Output Power		Output Voltage V1	Output Current		Ripple & Noise	Efficiency <sup>(1)</sup>	Model Number
High Line	Low Line		High Line	Low Line			
3000W	2000W	150VDC	20.0A	13.3A	1500mV	91%	HDL3000PS150
3000W	2000W	200VDC	15.0A	10.0A	2000mV	91%	HDL3000PS200
3000W	2000W	250VDC	12.0A	8.0A	2500mV	91%	HDL3000PS250
3000W	2000W	300VDC	10.0A	6.7A	3000mV	92%	HDL3000PS300
3000W	2000W	400VDC	7.50A	5.0A	4000mV	92%	HDL3000PS400

### Notes

1. Measured with 230 VAC input and full load.

### Input

Characteristic	Minimum	Typical	Maximum	Units	Notes & Conditions
Input Voltage	90		264	VAC	See derating curve
Input Frequency	47		63	Hz	
Power Factor		0.98/0.95			115/230 VAC full load
Input Current			19.7/14.5	A	115 VAC at 2000 W/230 VAC at 3000 W
Inrush Current			43/85	A	115/230 VAC
Earth Leakage Current			1	mA	264 VAC/60 Hz

### Output

Characteristic	Minimum	Typical	Maximum	Units	Notes & Conditions
Output Voltage	150		400	VDC	See Models and Ratings table.
Output Trim		±5.0		%	By potentiometer.
Output Voltage Program	0		105	%	Of rated output. Tolerance ±2%.
Output Current Program	0		105	%	Of rated output. Tolerance ±3%.
Output Voltage Tolerance			±2	%	Includes initial set accuracy, line & load regulation
Minimum Load	0			A	
Start Up Delay			1.1	s	
Start Up Rise Time			350	ms	At full load.
Hold Up Time		10		ms	At 230 VAC and full load.
Line Regulation			±1.0	%	
Load Regulation			±1 <sup>(V1)</sup> /±3	%	V1 Standby. 0-100% load.
Transient Response		<1		%	For a 25% step load change.
Ripple & Noise	1500		4000	mV pk-pk	See models and ratings table. Measured with 20 MHz bandwidth and using 12" twisted pair wire terminated with 0.1 µF ceramic capacitor and 47 µF electrolytic at 25 °C ambient.
Overvoltage Protection					Tracks output voltage, see application notes. Recycle AC to reset. Tolerance 7%.
Overtemperature Protection					Internally. Output shuts down, auto recovers.
Overload Protection		105		%	Rated power, constant current.
Short Circuit Protection					Auto recovery.
Temperature Coefficient		±0.02		%/°C	0-50 °C.
Enable	Output must be enabled, see application notes, power supply is shipped with enable links fitted.				
Current Share	8 supplies can share within 5%. If total load is less than 5% of rated load only one unit will operate.				
Standby Output	5 V at 0.5 A, present whenever AC is applied (9 V at 0.3 A, user selectable, by connecting 'VSET', Pin 6 of CN5 to CN5 GND).				

### Output Voltage Programming

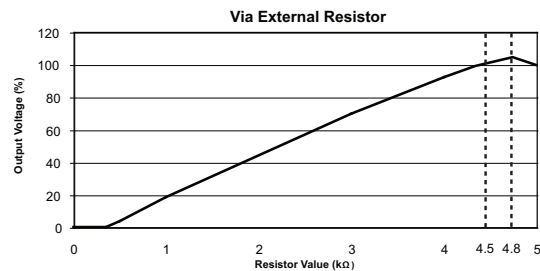
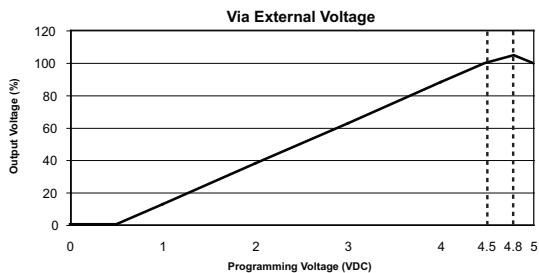

### Output Current Programming

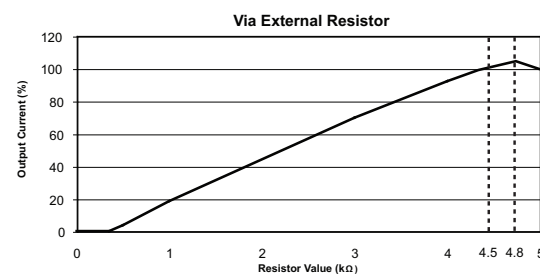
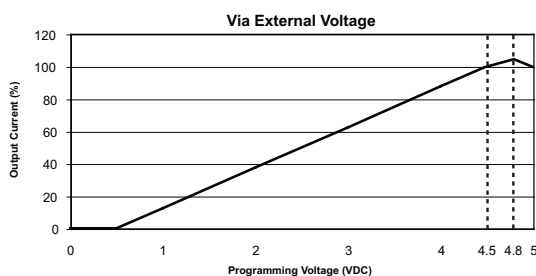

### General

Characteristic	Minimum	Typical	Maximum	Units	Notes & Conditions
Efficiency		91		%	See Models and Ratings table.
Isolation: Input to Output Input to Ground Output to Ground	3000			VAC	
	1500			VAC	
	500			VAC	
Switching Frequency		70		kHz	PFC.
	55		95		PWM, variable.
	40		150		Standby, variable.
Power Density			14.4	W/in <sup>3</sup>	
Signals and Controls					Enable, Current Share, V Program, I Program, 5 V Standby, Power OK.
Mean Time Between Failure		495		kHrs	MIL-HDBK-217F, 25 °C GB.
Weight		7.26 (3.3)		lb (kg)	

### Environmental

Characteristic	Minimum	Typical	Maximum	Units	Notes & Conditions
Operating Temperature	-20		60	°C	Derate linearly from 100% load at 50 °C to 50% load at 60 °C.
Storage Temperature	-40		+85	°C	10-95% RH, non condensing.
Cooling					Internal fan fitted, speed increases with load and internal temperature.
Humidity	20		90	%RH	Non condensing.
Operating Altitude			3000	m	
Vibration			2	g	10-500 Hz, 10 min/cycle, 60 min period for each axis, compliant to IEC60068-2-16, IEC 60068-2-64.

### Derating Curve

Thermal Derating Curve

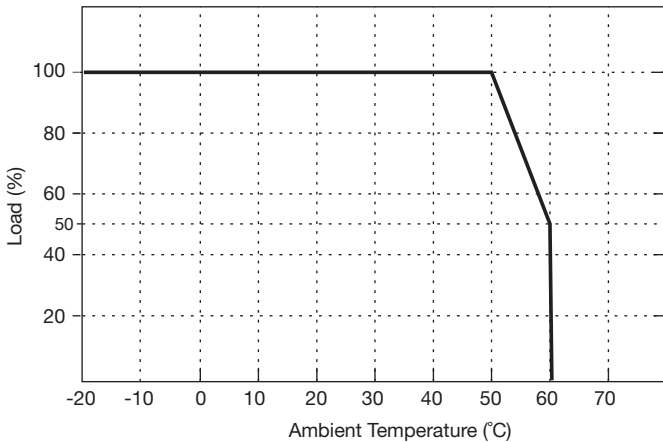

Input Derating Curve

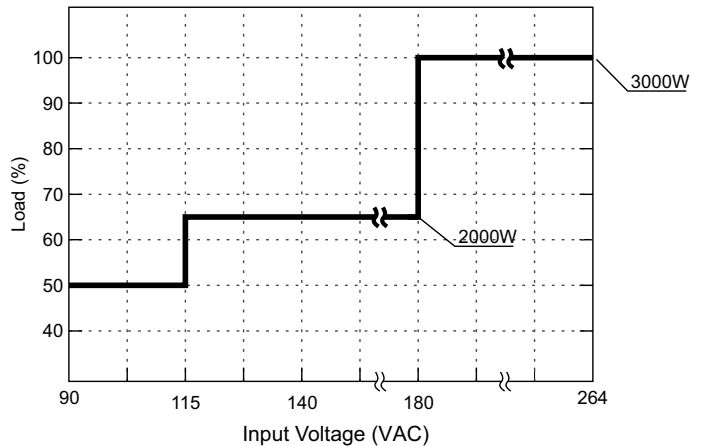

### Signals & Controls

LED Status	Output Status
Solid (Green)	DC Output OK
Solid (Orange)	DC Output OK in remote control mode
Slow Blink (Green)	Output Not Enabled
Fast Blink (Red)	Over Voltage
Solid (Red)	Over Loaded
Slow Blink (Red)	Over Temperature
Intermittent Blink (Red)	Fan Fail
Short & Long Blink (Red)	AUX Standby Failure

### Remote Enable

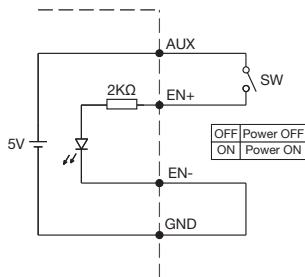

(A) Using internal 5 V standby

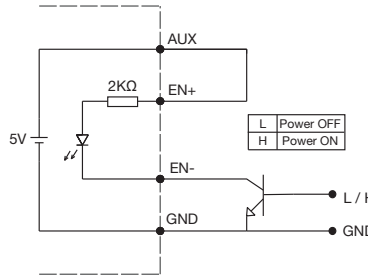

(B) Using external transistor

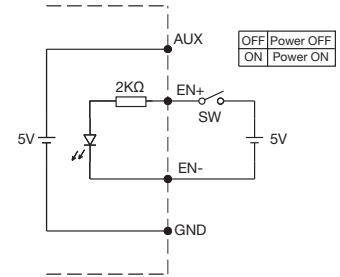

(C) Using external voltage source

### EMC: Emissions

Phenomenon	Standard	Test Level	Notes & Conditions
Conducted	EN55032	Class A	
Radiated	EN55032	Class A	
Harmonic Currents	EN61000-3-2	Class A	
Voltage Flicker	EN61000-3-3		

### EMC: Immunity

Phenomenon	Standard	Test Level	Criteria	Notes & Conditions
ESD Immunity	EN61000-4-2	2 / 3	A	±4 kV contact / ±8 kV air discharge
Radiated Immunity	EN61000-4-3	3 V/m	A	
EFT/Burst	EN61000-4-4	±1kV	A	
Surge	EN61000-4-5	Installation class 3	A	
Conducted	EN61000-4-6	3 Vrms	A	
Magnetic Field	EN61000-4-8	1A/m	A	
Dips and Interruptions	EN55024	DIP: 30% 500 ms	A	
		INT: >95% 10 ms	A	
		INT: >95% 5000 ms	B	

### Safety Approvals

Safety Agency	Safety Standard	Notes & Conditions
CB Report	IEC62368-1: 2014	Audio/Video, Information and Communication Technology Equipment
UL	UL62368-1, CAN/CSA C22.2 No.62368-1-14	
TUV	EN62368-1: 2014/A11: 2017	

### Application Notes

#### Power OK Signal

Open drain signal, low when PSU turns on. Maximum sink current: 20 mA  
Maximum drain voltage: 40 V

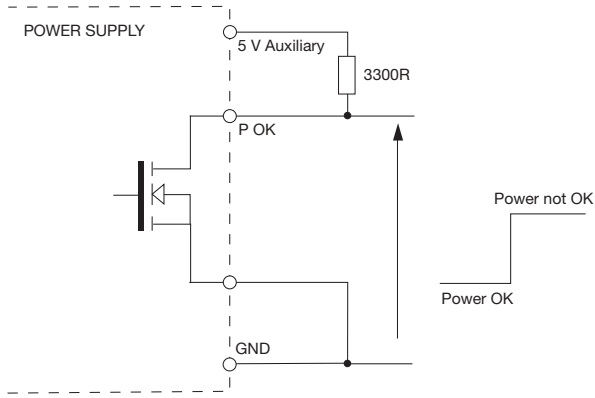

#### OVP Setting

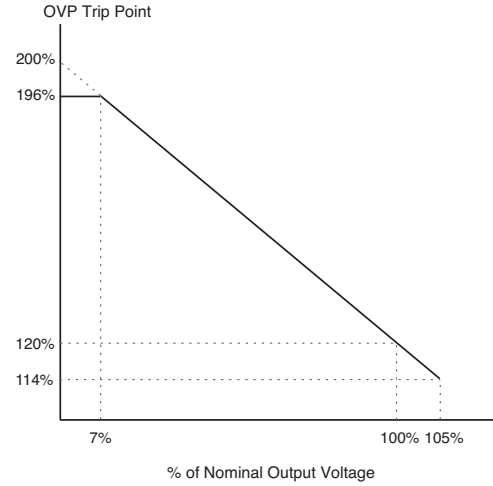

#### RS232 Connection Diagram

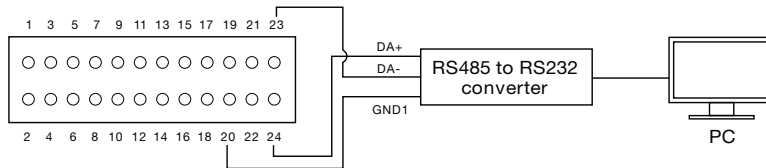

#### Current Sharing

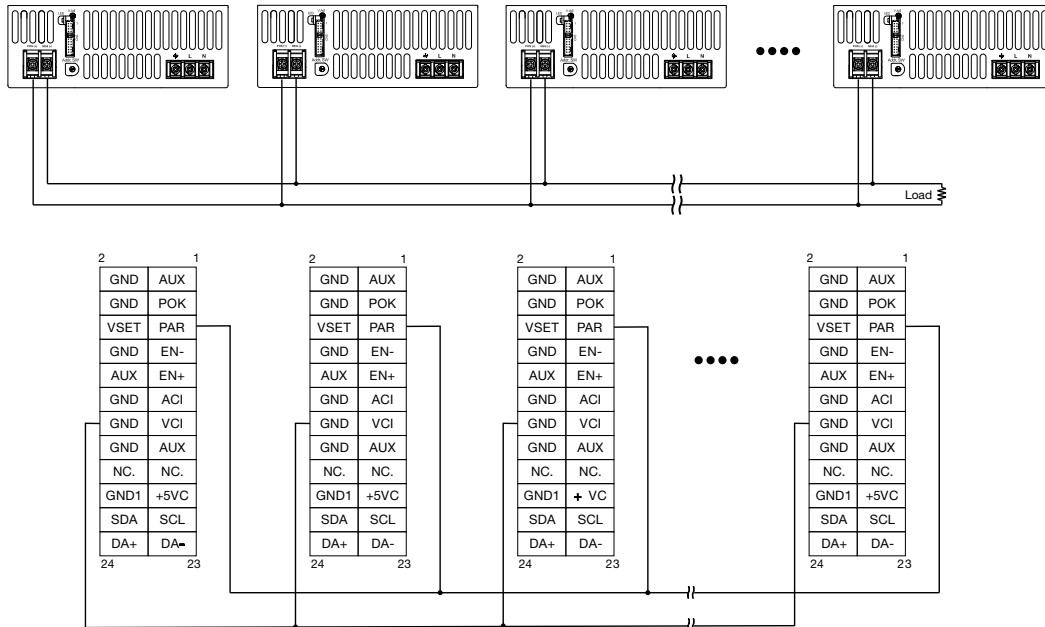

#### Notes

1. In parallel operation, it is possible that only one unit will operate if the load is less than 5% of the combined rated output load.
2. Output voltage of each PSU among parallel unit 3 should be <math><0.2\text{VDC}</math> difference.
3. Total output current must not exceed 90% of total rated current.

### Mechanical Details

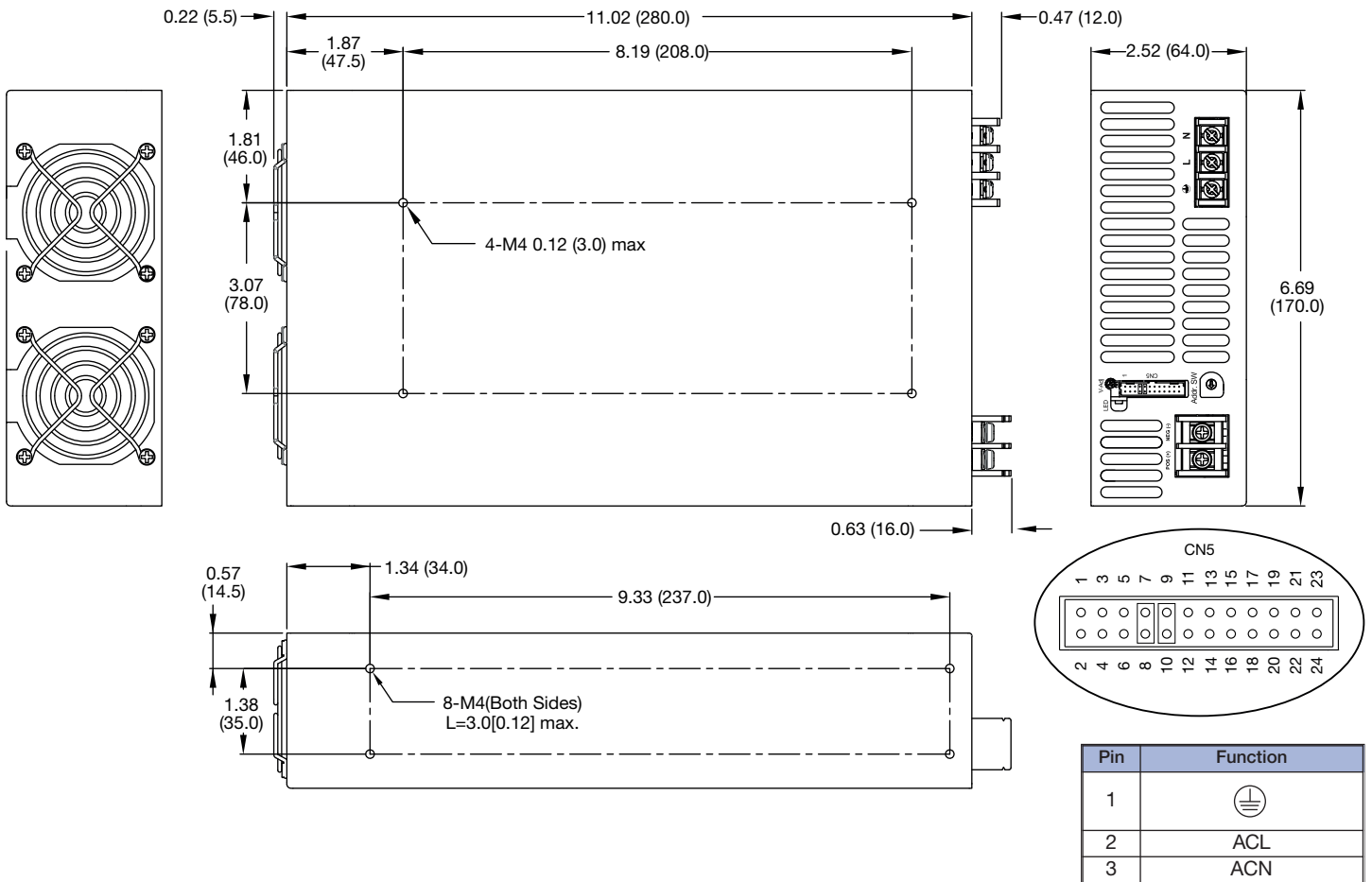

Pin	Function
1	⊥
2	ACL
3	ACN

CN5 Control Pin Connections								
Pin	Function	Description	Pin	Function	Description	Pin	Function	Description
1	AUX	+5V / 0.5A or +9V / 0.3A Auxiliary power	9	EN+	Inhibit ON/OFF (+)	17	N.C.	
2	GND	Ground	10	AUX	+5V / 0.5A or +9V / 0.3A Auxiliary power	18	N.C.	
3	POK	Power OK	11	ACI	I Program	19	+5VC	Use with GND1, isolated supply for I2C and RS485 interfaces
4	GND	Ground	12	GND	Ground	20	GND1	Use with +5VC, isolated supply for I2C and RS485 interfaces
5	PAR	Parallel operation current share	13	VCI	V Program	21	SCL	Serial Clock for I2C interface
6	VSET	Aux output setting	14	GND	Ground	22	SDA	Serial Data for I2C interface
7	EN-	Inhibit ON/OFF (-)	15	AUX	+5V / 0.5A or +9V / 0.3A Auxiliary power	23	DA-	For RS485 Data- Interface
8	GND	Ground	16	GND	Ground	24	DA+	For RS485 Data+ Interface

### Notes

- Dimensions shown in inches (mm).
- Weight: 7.26 lb (3.3 kg)
- Mating Connector: CN5 JST PHDR-24VS Housing, SPHD-002T-P0.5 Contact
- Torque of mounting M4 screw: 1.27 Nm (13.0 kgf.cm)