

E11745

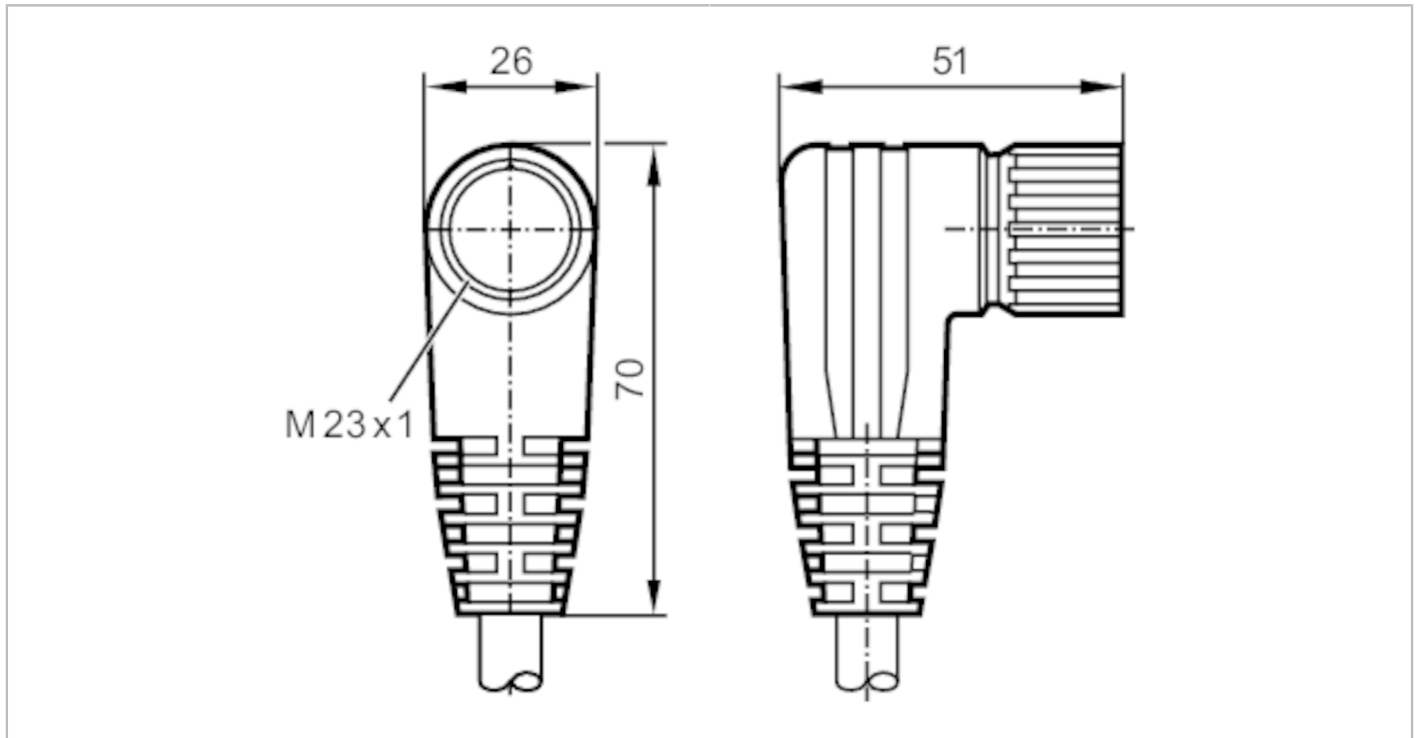

Connecting cable with socket

ADOAK190MSS0005H19



Application	
Special feature	Halogen-free
Electrical data	
Operating voltage [V]	< 63 AC/DC
Max. current load total [A]	8
Operating conditions	
Ambient temperature [°C]	-25...80
Protection	IP 67
Mechanical data	
Weight [g]	1165
Dimensions [mm]	51 x 26 x 70
Materials	PUR black
Material nut	brass, nickel-plated
Tightening torque [Nm]	2
Remarks	
Pack quantity	1 pcs.
Electrical connection	
Cable: 5 m, PUR, Halogen-free, black, Ø 11.6 mm; 16 x 0.5 mm ² (63 x Ø 0.1 mm) + 3 x 1.0 mm ² (127 x Ø 0.1 mm)	
Electrical connection - socket	
Connector: 1 x M23, angled; Moulded body: PUR; Locking: brass, nickel-plated	

E11745



Connecting cable with socket

ADOAK190MSS0005H19

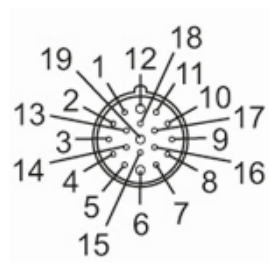

E11745



Connecting cable with socket

ADOAK190MSS0005H19

Connection

1	VT
2	RD
3	GY
4	RD/BU
5	GN
6	BU
7	GY/PK
8	WH/GN
9	WH/YE
10	WH/GY
11	BK
12	GN/YE
13	YE/BN
14	BN/GN
15	WH
16	YE
17	PK
18	GY/BN
19	BN

Core colours :

BK =	black
BN =	brown
BU =	blue
GN =	green
GY =	grey
PK =	pink
RD =	red
VT =	lilac
WH =	white
YE =	yellow

E11745

Connecting cable with socket

ADOAK190MSS0005H19

