

74AHC1G09

2-input AND gate with open-drain output

Rev. 02 — 18 December 2007

Product data sheet

1. General description

The 74AHC1G09 is a high-speed Si-gate CMOS device.

The 74AHC1G09 provides the 2-input AND function with open-drain output.

The output of the 74AHC1G09 is an open drain and can be connected to other open-drain outputs to implement active-LOW, wired-OR or active-HIGH wired-AND functions. For digital operation this device must have a pull-up resistor to establish a logic HIGH level.

2. Features

- High noise immunity
- Low power dissipation
- SOT353-1 and SOT753 package options
- ESD protection:
 - ◆ HBM JESD22-A114E: exceeds 2000 V
 - ◆ MM JESD22-A115-A: exceeds 200 V
 - ◆ CDM JESD22-C101C: exceeds 1000 V
- Specified from $-40\text{ }^{\circ}\text{C}$ to $+85\text{ }^{\circ}\text{C}$ and from $-40\text{ }^{\circ}\text{C}$ to $+125\text{ }^{\circ}\text{C}$.

3. Ordering information

Table 1. Ordering information

Type number	Package			
	Temperature range	Name	Description	Version
74AHC1G09GW	$-40\text{ }^{\circ}\text{C}$ to $+125\text{ }^{\circ}\text{C}$	TSSOP5	plastic thin shrink small outline package; 5 leads; body width 1.25 mm	SOT353-1
74AHC1G09GV	$-40\text{ }^{\circ}\text{C}$ to $+125\text{ }^{\circ}\text{C}$	SC-74A	plastic surface-mounted package; 5 leads	SOT753

4. Marking

Table 2. Marking

Type number	Marking code
74AHC1G09GW	A9
74AHC1G09GV	A09

5. Functional diagram

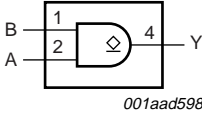
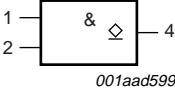
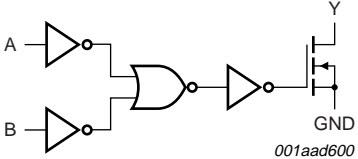
 <p>001aad598</p>	 <p>001aad599</p>	 <p>001aad600</p>
<p>Fig 1. Logic symbol</p>	<p>Fig 2. IEC logic symbol</p>	<p>Fig 3. Logic diagram</p>

6. Pinning information

6.1 Pinning

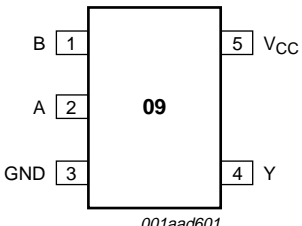

001aad601

Fig 4. Pin configuration SOT353-1 (TSSOP5) and SOT753 (SC-74A)

6.2 Pin description

Table 3. Pin description

Symbol	Pin	Description
B	1	data input B
A	2	data input A
GND	3	ground (0 V)
Y	4	data output Y
V _{CC}	5	supply voltage

7. Functional description

Table 4. Function table^[1]

Input		Output
A	B	Y
L	L	L
L	H	L
H	L	L
H	H	Z

[1] H = HIGH voltage level; L = LOW voltage level; Z = high-impedance OFF-state.

8. Limiting values

Table 5. Limiting values

In accordance with the Absolute Maximum Rating System (IEC 60134). Voltages are referenced to GND (ground = 0 V).

Symbol	Parameter	Conditions	Min	Max	Unit
V _{CC}	supply voltage		-0.5	+7.0	V
V _I	input voltage		[1] -0.5	+7.0	V
V _O	output voltage	active mode	[1] -0.5	+7.0	V
		high-impedance mode	[1] -0.5	+7.0	V
I _{IK}	input clamping current	V _I < -0.5 V	[1] -	-20	mA
I _{OK}	output clamping current	V _O < -0.5 V	[1] -	±20	mA
I _O	output current	V _O > -0.5 V	-	25	mA
I _{CC}	supply current		-	±75	mA
I _{GND}	GND current		-	±75	mA
T _{stg}	storage temperature		-65	+150	°C
P _{tot}	total power dissipation	T _{amb} = -40 °C to +125 °C	[2] -	250	mW

[1] The input and output voltage ratings may be exceeded if the input and output current ratings are observed.

[2] For TSSOP5 and SC-74A packages: above 87.5 °C the value of P_{tot} derates linearly with 4.0 mW/K.

9. Recommended operating conditions

Table 6. Recommended operating operations

Symbol	Parameter	Conditions	Min	Typ	Max	Unit
V _{CC}	supply voltage		2.0	5.0	5.5	V
V _I	input voltage		0	-	5.5	V
V _O	output voltage	active mode	0	-	V _{CC}	V
		high-impedance mode	0	-	6.0	V
T _{amb}	ambient temperature		-40	+25	+125	°C
Δt/ΔV	input transition rise and fall rate	V _{CC} = 3.0 V to 3.6 V	-	-	100	ns/V
		V _{CC} = 4.5 V to 5.5 V	-	-	20	ns/V

10. Static characteristics

Table 7. Static characteristics

Voltages are referenced to GND (ground = 0 V).

Symbol	Parameter	Conditions	25 °C			-40 °C to +85 °C		-40 °C to +125 °C		Unit
			Min	Typ	Max	Min	Max	Min	Max	
V _{IH}	HIGH-level input voltage	V _{CC} = 2.0 V	1.5	-	-	1.5	-	1.5	-	V
		V _{CC} = 3.0 V	2.1	-	-	2.1	-	2.1	-	V
		V _{CC} = 5.5 V	3.85	-	-	3.85	-	3.85	-	V
V _{IL}	LOW-level input voltage	V _{CC} = 2.0 V	-	-	0.5	-	0.5	-	0.5	V
		V _{CC} = 3.0 V	-	-	0.9	-	0.9	-	0.9	V
		V _{CC} = 5.5 V	-	-	1.65	-	1.65	-	1.65	V

Table 7. Static characteristics ...continued
 Voltages are referenced to GND (ground = 0 V).

Symbol	Parameter	Conditions	25 °C			-40 °C to +85 °C		-40 °C to +125 °C		Unit
			Min	Typ	Max	Min	Max	Min	Max	
V _{OL}	LOW-level output voltage	V _I = V _{IH} or V _{IL}								
		I _O = 50 μA; V _{CC} = 2.0 V	-	0	0.1	-	0.1	-	0.1	V
		I _O = 50 μA; V _{CC} = 3.0 V	-	0	0.1	-	0.1	-	0.1	V
		I _O = 50 μA; V _{CC} = 4.5 V	-	0	0.1	-	0.1	-	0.1	V
		I _O = 4.0 mA; V _{CC} = 3.0 V	-	-	0.36	-	0.44	-	0.55	V
		I _O = 8.0 mA; V _{CC} = 4.5 V	-	-	0.36	-	0.44	-	0.55	V
I _I	input leakage current	V _I = 5.5 V or GND; V _{CC} = 0 V to 5.5 V	-	-	±0.1	-	±1.0	-	±2.0	μA
I _{OZ}	OFF-state output current	V _I = V _{IH} or V _{IL} ; V _O = V _{CC} or GND; V _{CC} = 5.5 V	-	-	±0.25		±2.5		±10.0	μA
I _{CC}	supply current	V _I = V _{CC} or GND; I _O = 0 A; V _{CC} = 5.5 V	-	-	1.0	-	10	-	20	μA
C _I	input capacitance		-	1.5	10	-	10	-	10	pF

11. Dynamic characteristics

Table 8. Dynamic characteristics
 GND = 0 V; for test circuit see [Figure 6](#).

Symbol	Parameter	Conditions	25 °C			-40 °C to +85 °C		-40 °C to +125 °C		Unit
			Min	Typ	Max	Min	Max	Min	Max	
t _{pd}	propagation delay	A and B to Y; see Figure 5								
		V _{CC} = 3.0 V to 3.6 V								
		C _L = 15 pF	-	4.6	7.5	1.0	8.5	1.0	9.0	ns
		C _L = 50 pF	-	6.5	11.0	1.5	12.0	1.5	12.5	ns
		V _{CC} = 4.5 V to 5.5 V								
		C _L = 15 pF	-	3.2	5.5	1.0	6.5	1.0	7.0	ns
		C _L = 50 pF	-	4.6	7.5	1.5	8.0	1.5	8.5	ns
C _{PD}	power dissipation capacitance	C _L = 50 pF; f _i = 1 MHz; V _I = GND to V _{CC}	-	5	-	-	-	-	-	pF

[1] t_{pd} is the same as t_{pZL} and t_{pLZ}.

[2] Typical values are measured at V_{CC} = 3.3 V.

[3] Typical values are measured at V_{CC} = 5.0 V.

[4] C_{PD} is used to determine the dynamic power dissipation (P_D in μW).

$$P_D = C_{PD} \times V_{CC}^2 \times f_i \times N + (C_L \times V_{CC}^2 \times f_o)$$

f_i = input frequency in MHz;

f_o = output frequency in MHz;

C_L = output load capacitance in pF;

V_{CC} = supply voltage in V;

N = number of inputs switching;

(C_L × V_{CC}² × f_o) = dissipation due to the output if the combination of the pull up voltage and resistance results in V_{CC} at the output.

12. Waveforms

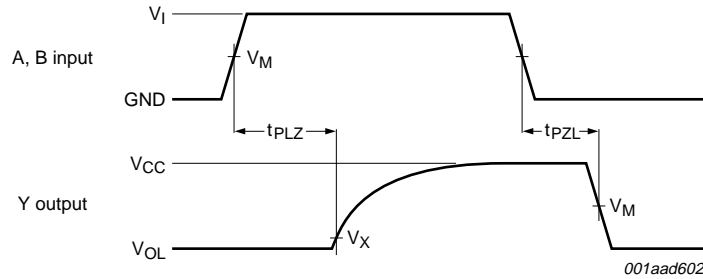

Measurement points are given in [Table 9](#).
 V_{OL} is the typical voltage output level that occur with the output load.

Fig 5. The data input (A, B) to output (Y) propagation delays

Table 9. Measurement points

Input	Output	
V_M	V_M	V_X
$0.5V_{CC}$	$0.5V_{CC}$	$V_{OL} + 0.3 V$

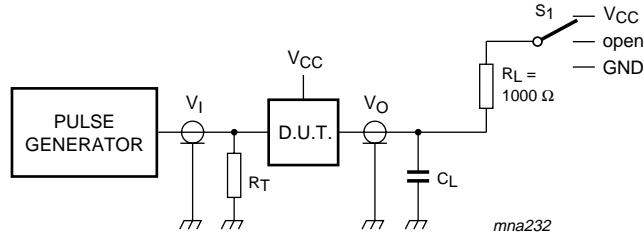

Test data is given in [Table 10](#).
 Definitions for test circuit:
 C_L = Load capacitance including jig and probe capacitance.
 R_T = Termination resistance should be equal to output impedance Z_o of the pulse generator.

Fig 6. Load circuit for switching times

Table 10. Test data

Input		Load		S_1		
V_I	t_r, t_f	R_L	C_L	t_{PHZ}, t_{PZH}	t_{PLZ}, t_{PZL}	t_{PLH}, t_{PHL}
GND to V_{CC}	$\leq 3.0 \text{ ns}$	1000Ω	15 pF	GND	V_{CC}	open
GND to V_{CC}	$\leq 3.0 \text{ ns}$	1000Ω	50 pF	GND	V_{CC}	open

13. Package outline

TSSOP5: plastic thin shrink small outline package; 5 leads; body width 1.25 mm

SOT353-1



Fig 7. Package outline SOT353-1 (TSSOP5)

Plastic surface-mounted package; 5 leads

SOT753

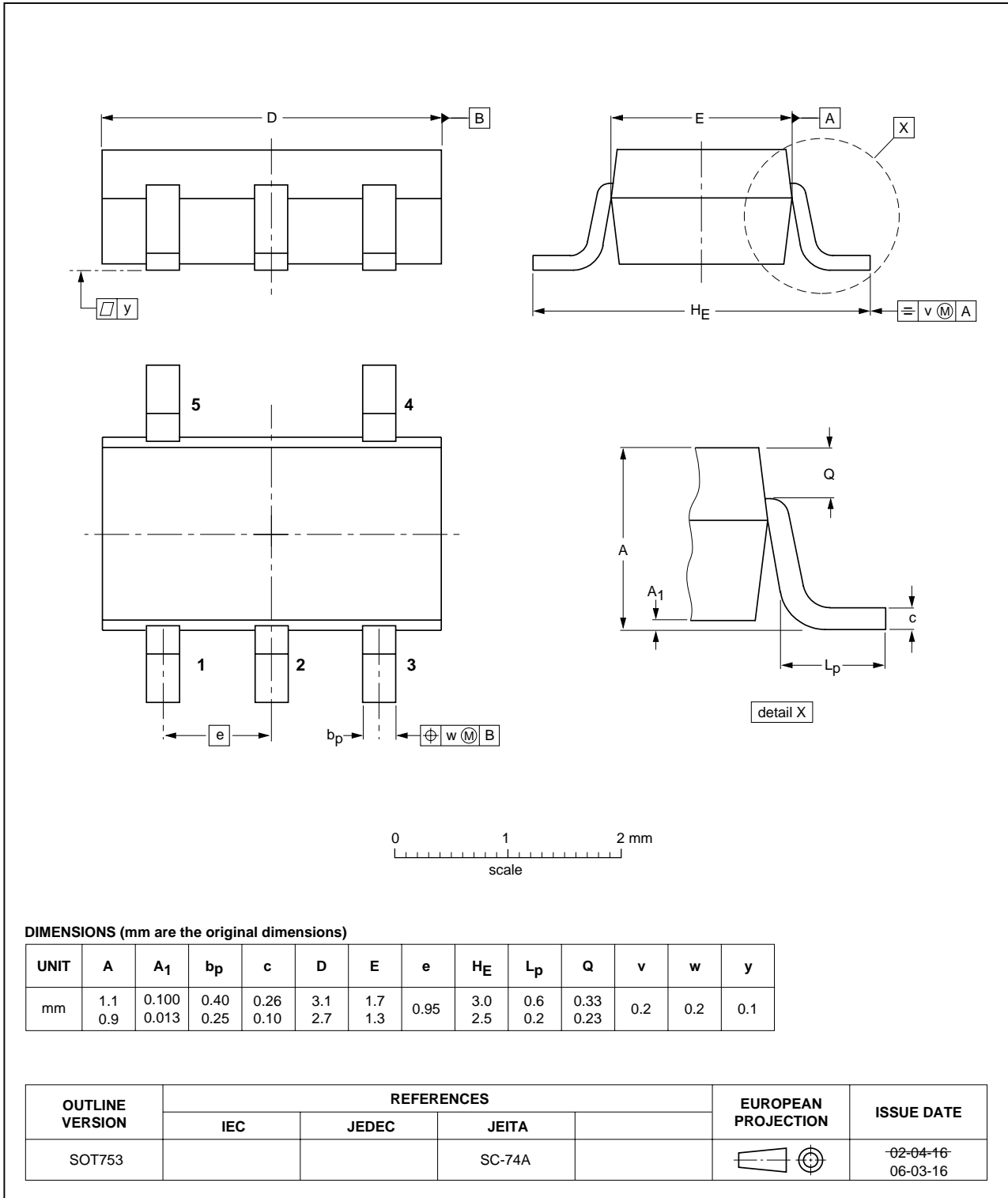

Fig 8. Package outline SOT753 (SC-74A)

14. Abbreviations

Table 11. Abbreviations

Acronym	Description
CDM	Charged Device Model
DUT	Device Under Test
ESD	ElectroStatic Discharge
HBM	Human Body Model
MM	Machine Model

15. Revision history

Table 12. Revision history

Document ID	Release date	Data sheet status	Change notice	Supersedes
74AHC1G09_2	20071218	Product data sheet	-	74AHC1G09_1
Modifications:		<ul style="list-style-type: none">• The format of this data sheet has been redesigned to comply with the new identity guidelines of NXP Semiconductors.• Legal texts have been adapted to the new company name where appropriate.• Package SOT753 added to Section 3, Section 4 and Section 13.• Quick reference data section removed.		
74AHC1G09_1	20050926	Product data sheet	-	-

16. Legal information

16.1 Data sheet status

Document status ^{[1][2]}	Product status ^[3]	Definition
Objective [short] data sheet	Development	This document contains data from the objective specification for product development.
Preliminary [short] data sheet	Qualification	This document contains data from the preliminary specification.
Product [short] data sheet	Production	This document contains the product specification.

[1] Please consult the most recently issued document before initiating or completing a design.

[2] The term 'short data sheet' is explained in section "Definitions".

[3] The product status of device(s) described in this document may have changed since this document was published and may differ in case of multiple devices. The latest product status information is available on the Internet at URL <http://www.nxp.com>.

16.2 Definitions

Draft — The document is a draft version only. The content is still under internal review and subject to formal approval, which may result in modifications or additions. NXP Semiconductors does not give any representations or warranties as to the accuracy or completeness of information included herein and shall have no liability for the consequences of use of such information.

Short data sheet — A short data sheet is an extract from a full data sheet with the same product type number(s) and title. A short data sheet is intended for quick reference only and should not be relied upon to contain detailed and full information. For detailed and full information see the relevant full data sheet, which is available on request via the local NXP Semiconductors sales office. In case of any inconsistency or conflict with the short data sheet, the full data sheet shall prevail.

16.3 Disclaimers

General — Information in this document is believed to be accurate and reliable. However, NXP Semiconductors does not give any representations or warranties, expressed or implied, as to the accuracy or completeness of such information and shall have no liability for the consequences of use of such information.

Right to make changes — NXP Semiconductors reserves the right to make changes to information published in this document, including without limitation specifications and product descriptions, at any time and without notice. This document supersedes and replaces all information supplied prior to the publication hereof.

Suitability for use — NXP Semiconductors products are not designed, authorized or warranted to be suitable for use in medical, military, aircraft, space or life support equipment, nor in applications where failure or

malfunction of an NXP Semiconductors product can reasonably be expected to result in personal injury, death or severe property or environmental damage. NXP Semiconductors accepts no liability for inclusion and/or use of NXP Semiconductors products in such equipment or applications and therefore such inclusion and/or use is at the customer's own risk.

Applications — Applications that are described herein for any of these products are for illustrative purposes only. NXP Semiconductors makes no representation or warranty that such applications will be suitable for the specified use without further testing or modification.

Limiting values — Stress above one or more limiting values (as defined in the Absolute Maximum Ratings System of IEC 60134) may cause permanent damage to the device. Limiting values are stress ratings only and operation of the device at these or any other conditions above those given in the Characteristics sections of this document is not implied. Exposure to limiting values for extended periods may affect device reliability.

Terms and conditions of sale — NXP Semiconductors products are sold subject to the general terms and conditions of commercial sale, as published at <http://www.nxp.com/profile/terms>, including those pertaining to warranty, intellectual property rights infringement and limitation of liability, unless explicitly otherwise agreed to in writing by NXP Semiconductors. In case of any inconsistency or conflict between information in this document and such terms and conditions, the latter will prevail.

No offer to sell or license — Nothing in this document may be interpreted or construed as an offer to sell products that is open for acceptance or the grant, conveyance or implication of any license under any copyrights, patents or other industrial or intellectual property rights.

16.4 Trademarks

Notice: All referenced brands, product names, service names and trademarks are the property of their respective owners.

17. Contact information

For additional information, please visit: <http://www.nxp.com>

For sales office addresses, send an email to: salesaddresses@nxp.com

18. Contents

1 **General description** 1

2 **Features** 1

3 **Ordering information** 1

4 **Marking** 1

5 **Functional diagram** 2

6 **Pinning information** 2

6.1 Pinning 2

6.2 Pin description 2

7 **Functional description** 2

8 **Limiting values** 3

9 **Recommended operating conditions** 3

10 **Static characteristics** 3

11 **Dynamic characteristics** 4

12 **Waveforms** 5

13 **Package outline** 6

14 **Abbreviations** 8

15 **Revision history** 8

16 **Legal information** 9

16.1 Data sheet status 9

16.2 Definitions 9

16.3 Disclaimers 9

16.4 Trademarks 9

17 **Contact information** 9

18 **Contents** 10

Please be aware that important notices concerning this document and the product(s) described herein, have been included in section 'Legal information'.



© NXP B.V. 2007.

All rights reserved.

For more information, please visit: <http://www.nxp.com>

For sales office addresses, please send an email to: salesaddresses@nxp.com

Date of release: 18 December 2007

Document identifier: 74AHC1G09_2