

# Sensor Solutions for Automotive, Industrial and Consumer Applications

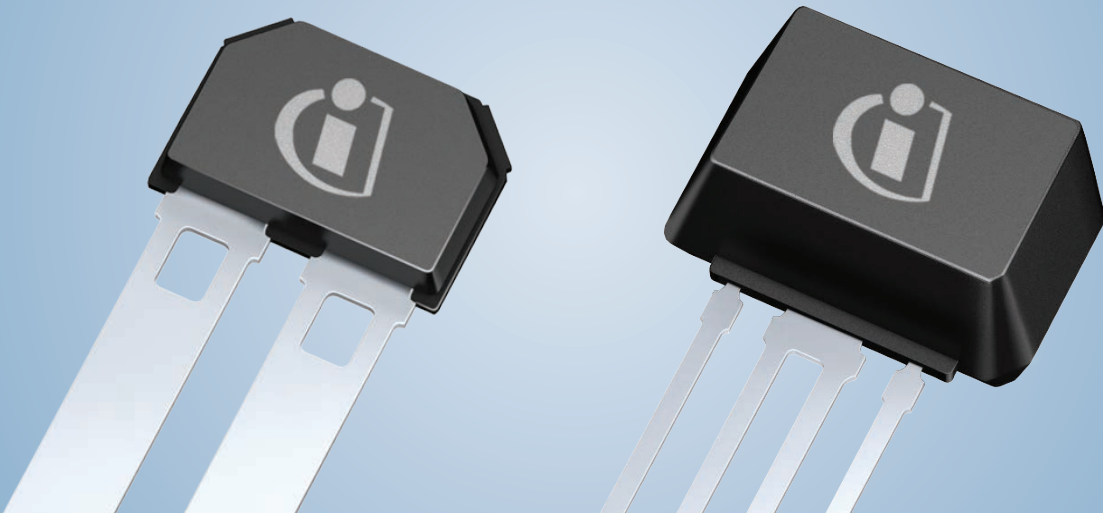

# Content

Introduction	3
Applications	6
Hall Switches	17
3D Magnetic Sensor	22
Linear Hall Sensors	23
Dual-Sensor Package	24
Angle Sensors	26
Magnetic Speed Sensors	28
Current Sensor	41
Integrated Pressure Sensor ICs	42
Tire Pressure Sensor	47
Front-End ICs for Automotive Radars (RASIC™)	48
Functional Safety	49
Infineon's PRO-SIL™ Program	49
Online Simulation Tools	50
Packages	51



# Infineon Sensors – Making Lives Easier, Safer and More Comfortable

At Infineon, we strive for in making lives **easier, safer and more comfortable by application of sensor technologies**. Leveraging our full innovation potential, our sensor ICs are at the heart of a wide range of sensing applications. They transform physical readings such as barometric air pressure, car tire pressure or various magnetic fields into electronic signals, which can then be processed further. To do this, the sensor ICs have to be in direct contact with the outside world, often functioning as standalone satellites that are not part of a protected circuit board. This means that they are exposed to significantly harsher mechanical, chemical and electrical forces than conventional semiconductor devices. The ability to withstand these environments calls for special packaging technologies, dedicated silicon processes and robust sensing elements – making sensor ICs complex and challenging devices to manufacture.

## **Infineon is a strong partner for sensor applications**

As a broad-line supplier, Infineon draws upon 40 years of experience in sensor design and production and provides the broadest magnetic sensor portfolio in the market.

The company has sold more than three billion integrated magnetic and pressure sensors over the past 10 years. Infineon is number one in wheel speed and pressure sensors for both side airbags and tire pressure monitoring systems. With regard to Electric Power Steering (EPS), Infineon once again leads the way with a market share of about one third. As a strong partner, the company supplies the automotive market with more than one million sensors per day.

## **Watch now – Leading Magnetic Sensor Technology by Infineon**



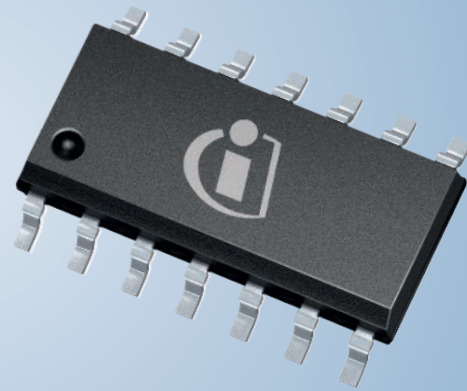
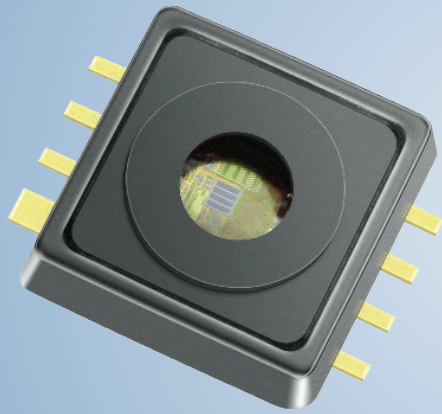

Today, a new car features up to 80 applications that rely on magnetic sensors. And this number is growing. We have kept pace with this development by diversifying our product offering. Whereas ten years ago, one type of speed sensor would have covered most speed sensing applications, we now have dedicated product lines for wheel speed, transmission speed, crankshaft and camshaft sensing. Our magnetic sensor portfolio now comprises over 250 different products.

At Infineon, we are committed to making cars **safer**. Our **side airbag pressure sensors**, for example, detect the spike in pressure caused by a side impact and trigger the side airbag. These sensors are located in the door compartments of a car and are regarded as the fastest method of deploying life-saving side airbags. Similar devices are also used in new pedestrian protection systems. These are designed to release a car's hood if it is involved in a collision with a pedestrian, thus lessening the impact for the pedestrian. The sensors are located in a tube in the car's bumper and trigger the hood if they detect a spike in pressure.

Our sensors for **Tire Pressure Monitoring System (TPMS)** also help to raise car safety levels by warning drivers of any loss in tire pressure. These important safety features are also good for energy efficiency – a car with tires that are not fully inflated consumes more fuel and the tires wear down more quickly. Pressure-related downtime is a significant cost factor for many operators of commercial vehicles, for instance. We have already shipped over 150 million TPMS sensors covering all tire pressure ranges, making us the **leading provider** of these safety-critical components for automotive system suppliers.

**Ease of use** is another factor that impacts driver comfort and safety. Our SiGe-based 77-GHz RF transmitters/receivers, for

example, come in high-volume eWLB packages and are the ideal building blocks for cost-efficient **radar** systems used in Automotive Cruise Control (ACC), Blind-Spot Detection (BSD) and Auto-Emergency-Braking (AEB) applications. They also address upcoming Euro NCAP requirements for active passenger and pedestrian safety features.

Barometric air pressure sensors, for example, apply different pressure levels to various segments in a car seat to increase **comfort** levels. **Wheel speed** sensor ICs are also used to measure the speed of each wheel and detect whether a wheel blocks during braking (ABS). This measurement is also the basic input signals for a car's Electronic Stability Program (ESP). ESP makes it easier – and therefore safer – for drivers to handle a car in critical situations. **Magnetic angle sensors** and **linear Hall** sensors are also used to measure **steering angle** and **steering torque**.

#### Watch now – Leading Infineon Sensors for Industrial Applications

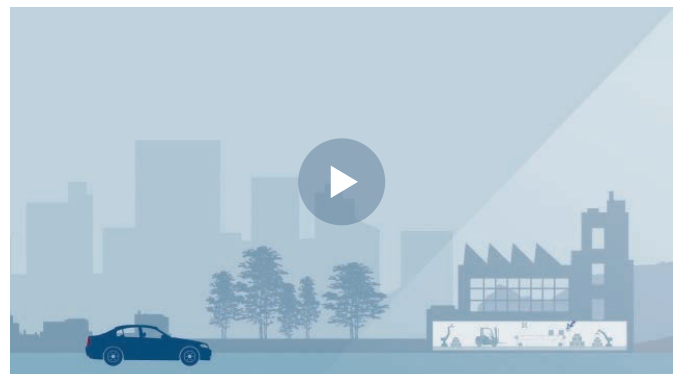

[www.infineon.com/sensors](http://www.infineon.com/sensors)



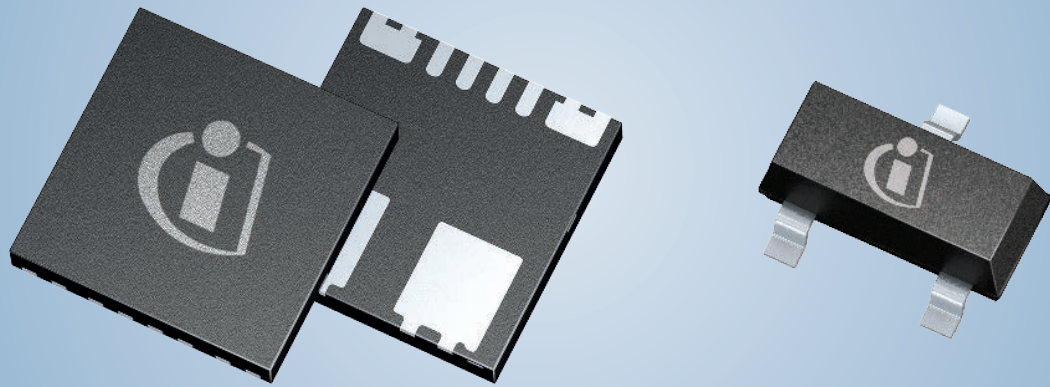

The number of **industrial and consumer** applications that rely on magnetic and pressure sensor ICs is also on the rise, further fuelling demand for our products. Our Hall switches, for example, comprise Infineon's latest easy-to-use and cost-effective Hall sensor family for consumer applications, as well as magnetic angle sensors. Hall switches are also regarded as an ideal solution for current commutation in brushless drives (BLDC). Many applications require conventional block commutation – and Hall switches are the perfect fit here. Efficiency levels can be raised further by directly measuring the rotor angle. This saves energy and eliminates vibrations, which in turn cuts noise levels and ensures **smoother integration**. The same angle sensor products are used in **e-bikes**, paving the way for more comfortable and energy-saving mobility concepts.

Our latest 3D magnetic sensor family with low current consumption is dedicated for industrial and consumer applications such as tampering detection in e-meter and flow meter.

Providing sensor ICs for all of the examples above requires a very broad mix of technologies. As a **technology leader**, we use Hall and magnetoresistive sensing elements (GMR and AMR) for our monolithically integrated magnetic sensors. Our pressure sensors are built on surface and bulk micro machined MEMS technologies. Our extensive offering and exacting quality standards reflect our commitment to making lives **easier, safer and more comfortable**. We are often regarded as the industry benchmark.

Nowadays, cars are fitted with an average of 20 magnetic and low pressure sensors. Four of these are provided by Infineon.

Infineon is the only provider offering integrated sensor ICs based on Hall, iAMR and iGMR.

**More than 3 billion units shipped in the past decade**

2014: Introduction of new dual-sensor packages and a new vertical Hall sensor.

2015: Supporting our customers as they strive to achieve the highest ASIL on system level, we provide both the necessary support for qualification of existing pre- ISO 26262 products, and fully ISO 26262-compliant products of the future.

# Sensors in Powertrain Applications

## Engine

- Crankshaft 

---

- Camshaft Position 

---

- Manifold Air Pressure 



---

- Secondary Air Valve 

---

- Turbo Charger 

---

- Throttle Position  



---

- Variable Valve Position 



---

- HEV Electric Motor 

---

- Pedal Position  

---

- Exhaust Gas Recirculation (EGR)   



---

- DC/DC Converter 

## Transmission

- Clutch Position 



---

- Clutch Actuator  



---

- Transmission Speed 



---

- Transmission Actuator  



---

- Transmission Gear Position  



---

- Oil Pump  



---

- Park Lock  

---

- Gear Stick   







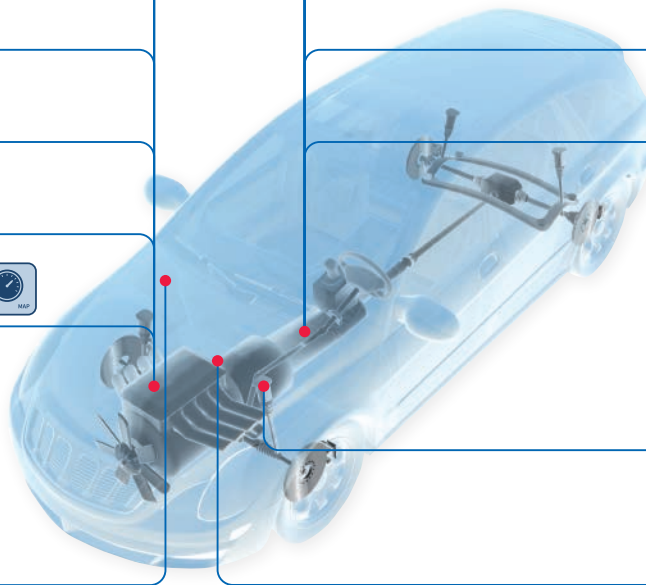

---

- Starter Generator  

---

- Barometric Air Pressure 



 Switches
  Linear Hall
  Angle Sensors
  Current Sensors
  BAP
  MAP
  Speed Sensors
  3D Magnetic Sensors

Crankshaft, camshaft and transmission speed sensors as well as MAP and BAP pressure sensors are only some of the key elements of multiple modern powertrain applications, such as engine and transmission, which significantly boost drivetrain efficiency. Our broad portfolio of products fits every customer requirement.

# Sensors in Body Applications

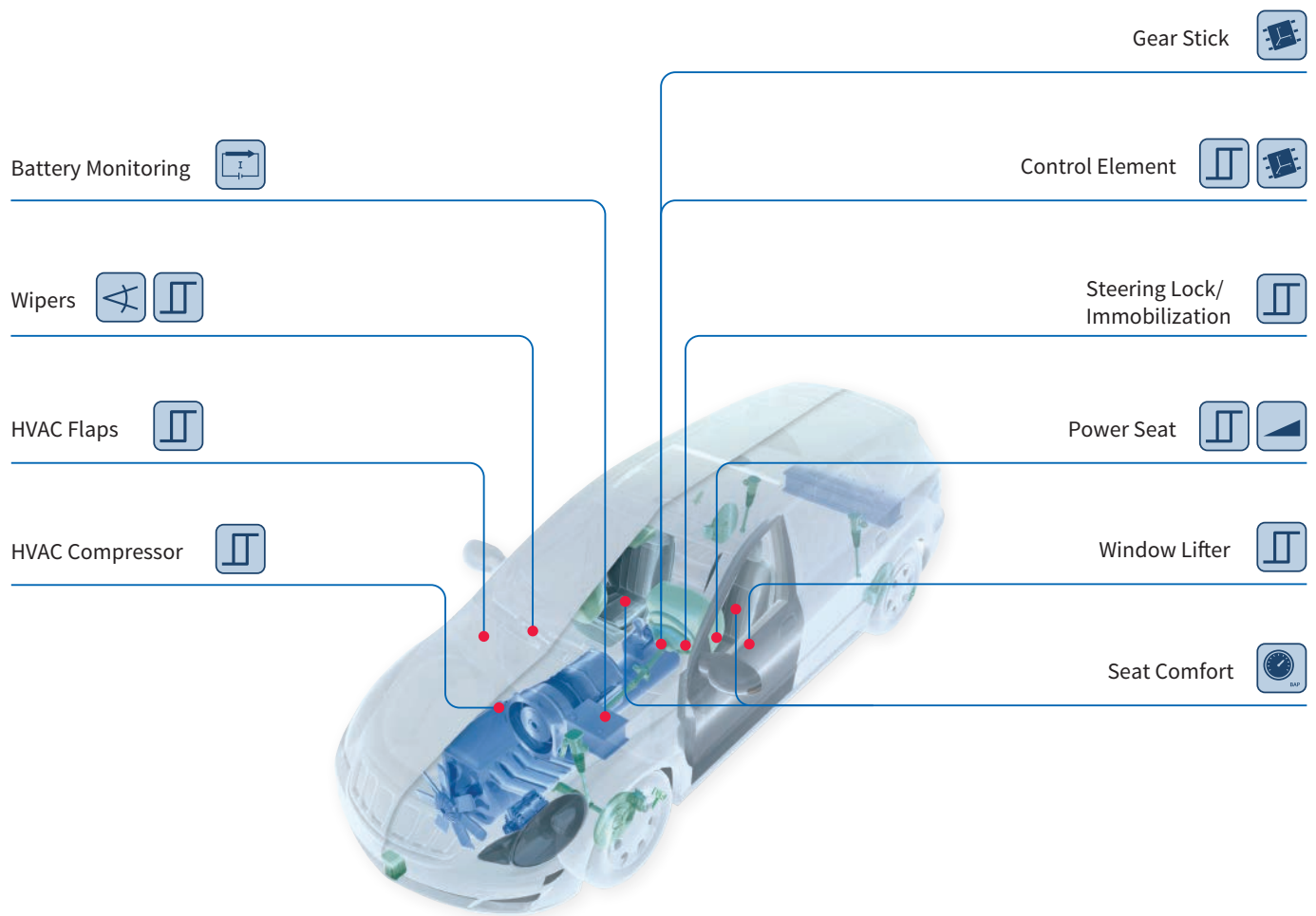

Switches

Linear  
HallAngle  
SensorsCurrent  
Sensors

BAP

3D Magnetic  
Sensors

The body segment presents the most diverse target market for sensors. Hall switches, for example, are deployed in classic applications such as window lift modules, whereas new seat comfort systems deploy pressure sensors to control individual pressure levels in seat cushions.

# Sensors in Safety Applications



## Braking

Wheel Speed 

Brake Booster  

Brake Pedal 

## Power Steering

Steering Torque  

Motor Position   

Steering Angle  

Pedestrian Protection 



Radar 

## Restraint Systems

Seatbelt Buckle 

Seat Position System 









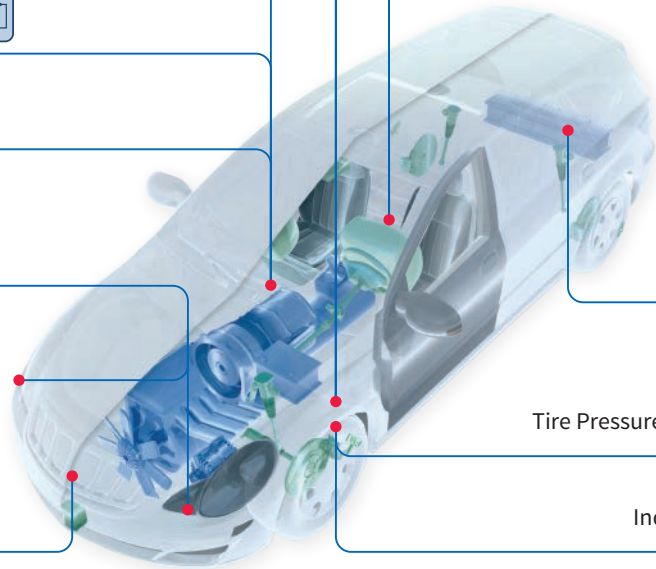

Side Crash Detection 

Chassis Height  

Tire Pressure Monitoring System (TPMS) 

Indirect TPMS System (ITPMS) 



- |  |   |   |   |  |
|--|---|---|---|--|
|  Switches |  Linear Hall |  Angle Sensors |  Pedestrian Protection |  Current Sensors                        |
|  Radar    |  BAP         |  Speed Sensors |  Side Airbag           |  Tire Pressure Monitoring System (TPMS) |

At Infineon, we focus in particular on sensors for safety applications. These include radars in automatic cruise control systems, wheel speed sensors in ABS and ESP features, pressure sensors in side airbags and pedestrian protection systems and TPMS sensors. We are the global market leader in most of these areas and our customers value the outstanding levels of quality and reliability that we deliver.



## A Typical Product to System Solution – Magnetic Sensors for Highest Energy Efficiency and Functional Safety in Electric Power Steering (EPS)

Compared to conventional hydraulic power steering solutions, Electric Power Steering (EPS) enables higher energy efficiency, increased steering functionality and a reduced build space in passenger vehicles.

The functionality of EPS is based on several system-side position sensors that measure the steering torque input from the driver, the position of the EPS motor that moves the steering rack and the steering wheel's absolute position.

### Typical Application for Infineon Magnetic Position Sensors in EPS

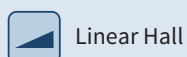
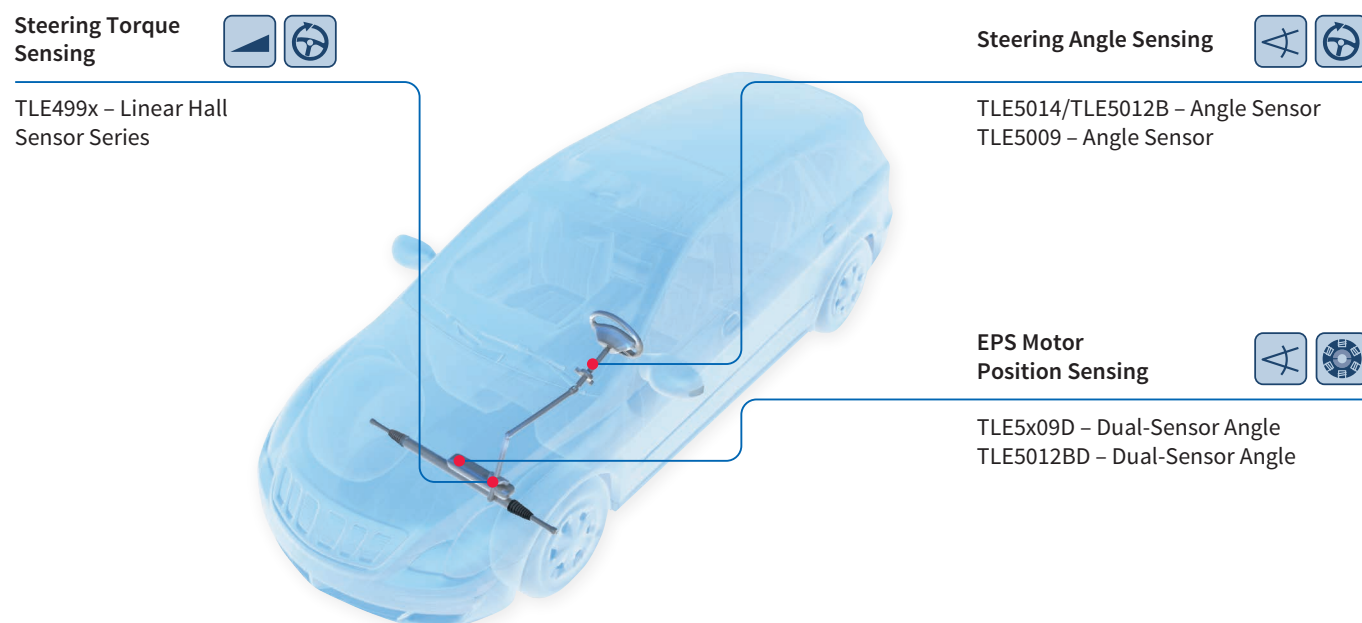

Linear Hall



Angle Sensors



Steering Torque



BLDC Motor

Position sensor applications in EPS are safety-related and typically rated with the highest ASIL-D safety level. The ISO 26262 standard sets high requirements for the diagnostic coverage of random failures and the avoidance of systematic failures in order to reach the highest ASIL-D safety level. These demanding specifications can typically be achieved by using redundant sensors as well as comparing their signals on a microcontroller.

Infineon offers dual-sensor solutions with two redundant sensors in the place of one for all position sensor applications in EPS. Our dual-sensor package integrates two magnetic position sensors with a separate power supply and separate signal outputs. They are electrically independent thanks to galvanic isolation. This means that the two sensors work independently, thereby increasing system reliability.

## A Typical Product to System Solution – Magnetic Sensors for the Ultimate in Energy Efficiency and Functional Safety in Electric Power Steering (EPS)

Side View of Innovative Stack-Mounted Dual-Sensor Technology with Bonding Wires

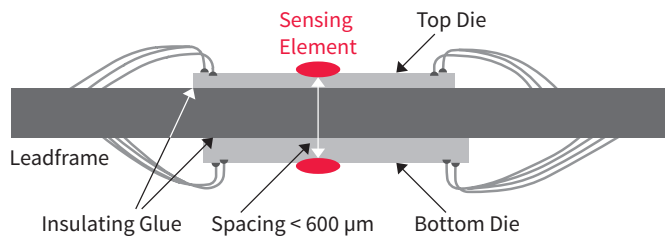

Transparent 3D-Graph of Dual-Sensor PG-TDSO-16-2 Package

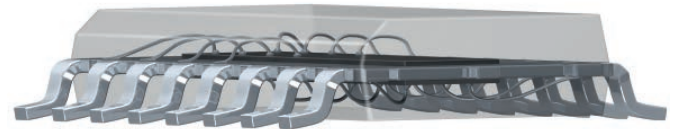

Thanks to the use of innovative stack-mounting technology, the devices of the angle sensor family combine two independent sensors within standard and space-saving PG-TDSO packages which are only about 1 mm thick. It has the same width and length as a conventional single-sensor package. Compared to the common approach of side-by-side sensor placement, the advantages of the top-bottom placement include a more homogeneous magnetic field over the sensing elements and a significantly smaller footprint. This saves precious space and cuts down on expense in safety-critical applications, as a lower-cost ferrite magnet can provide a sufficient magnetic field for the sensors.

## Steering Torque Sensors

In the field of steering torque sensing, Infineon's TLE499x series offers highly accurate linear Hall sensors for magnetic torque sensing assembly. In order to support a maximum of compatibility with various Electronic Control Unit (ECU) designs, the TLE499x sensors feature PWM, SENT, SPC or ratiometric analog output. They are available in leaded packages as well as 1 mm-thick dual- or single-sensor SMD packages.

	<b>TLE4997x</b>	Programmable linear Hall sensor with temperature compensation and ratiometric analog output. Available in a 3- or 4-pin leaded package (with or without integrated capacitors) and an 8-pin dual- or single-sensor SMD package.
	<b>TLE4998x</b>	Programmable linear Hall sensor with digital stress and temperature compensation and PWM, SENT or Short-PWM-Code (SPC) output. Available in a 3- or 4-pin leaded package (with or without integrated capacitors) and an 8-pin dual- or single-sensor SMD package.

### Magnetic Torque Sensing Assembly

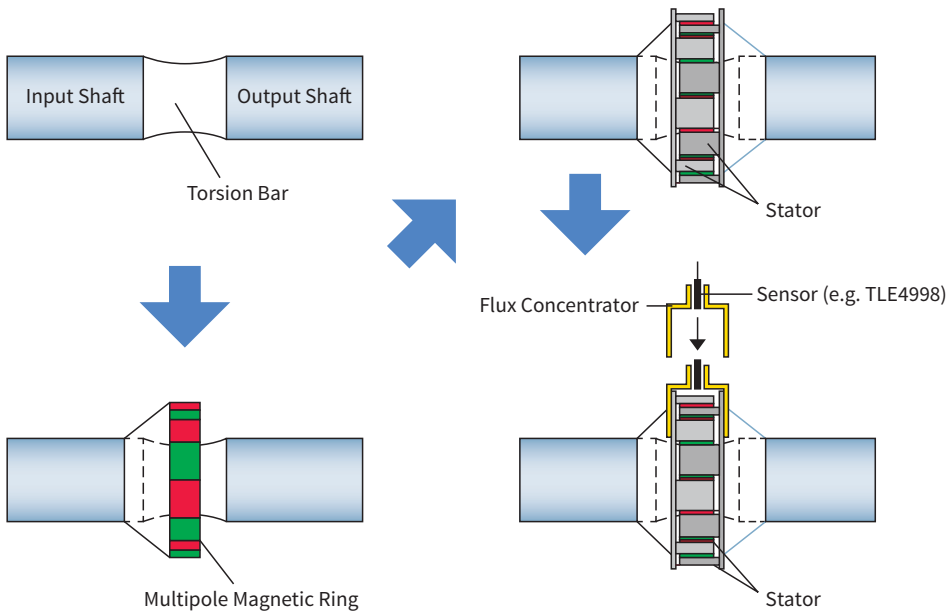

Conventional EPS systems using two linear Hall sensors for ASIL-D compliance have to shut-down in the event of a loss of one sensor signal. Therefore, the trend in EPS systems is to increase availability by implementing additional sensor signals or plausibility mechanisms. To support this trend towards High-Availability EPS functionality, Infineon recommends the usage of two TLE4998 dual-sensors. In case of one TLE4998 signal loss, the remaining dual-sensor in the system provides continued operation of the EPS, avoiding an immediate system shut-down.

### Application Trend: High-Availability

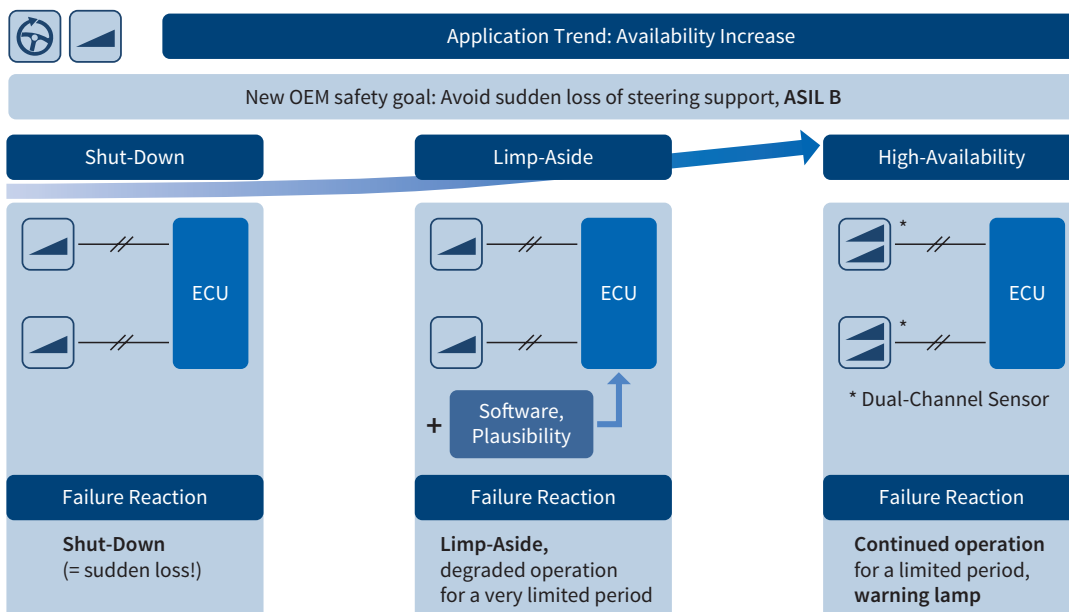



## Steering Angle Sensors

The absolute steering angle position is an input for the Electronic Stability Program (ESP) and other driver assistance systems. A typical module design used for steering angle measurement is a design featuring gear wheels with a slightly different number of gears. The angular positions of the gear wheels are measured by two angle sensors, where the absolute steering wheel position is calculated from those positions via the Vernier principle.

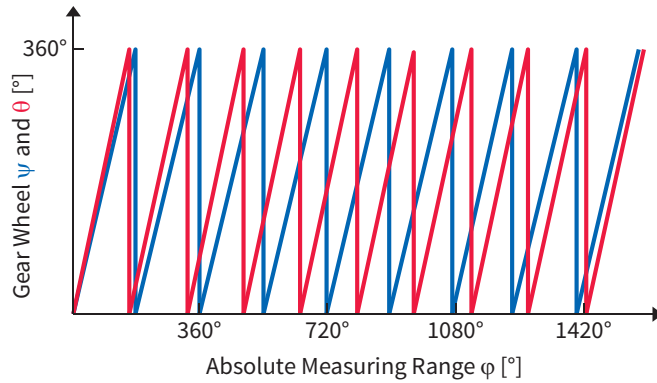
### Schematic Steering Angle Sensor Module and Illustration of the Vernier Principle



The angle sensors for absolute steering angle measurement are available as a single-sensor SMD package for conventional designs, which achieve the ASIL-D rating via a plausibility calculation of the two angle sensor signals as a result of a significant movement of the steering wheel. The sensors are also available in dual-sensor packages for module designs that support an ASIL-D-rated steering angle directly at power-on (ASIL-D from start).

	<b>TLE5009(D)</b>	Fast Giant-Magneto Resistive (GMR) angle sensor with analog Sin/Cos output. Available in a 16-pin single- and dual-sensor SMD package.
	<b>TLE5012B(D)</b>	Digital GMR angle sensor with SPI + PWM or SPC output. Available in a 16-pin single- and dual-sensor SMD package.
	<b>TLE5014(D)</b>	ISO 26262-compliant, programmable GMR angle sensor with PWM, SENT or SPC output. Supports Torque-Angle-Sensor (TAS) module bus configuration with TLE4998C or TLE4999. Will be available in a 16-pin single- and dual-sensor SMD package.

Infinion angle sensors support steering angle sensor configurations with an on-board microcontroller, as well as satellite sensor designs, due to a broad variety of supported communication interfaces. In particular, the SPC interface allows the connection of angle sensor(s) and linear Hall sensor(s) on a bus line in combined Torque-Angle-Sensor (TAS) modules. Compared to conventional designs with separate torque sensor and angle sensor modules, this configuration reduces the cost of wiring and saves module space.

### Schematic TAS Module Set-up and SPC Bus Configuration of the TLE5014 and TLE4998C

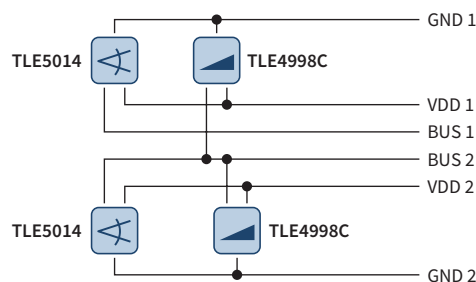
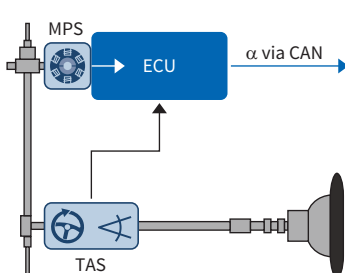

## EPS Motor Position Sensors

The motor that drives the steering rack in an EPS system is usually a highly efficient brushless DC (BLDC) motor which relies on a fast and accurate position sensor for commutation. In this application, short latency and high accuracy are essential, as these sensor parameters have a significant impact on torque stability and the energy efficiency of the motor.

### Schematic of BLDC Motor with a Magnetic Position Sensor for Commutation

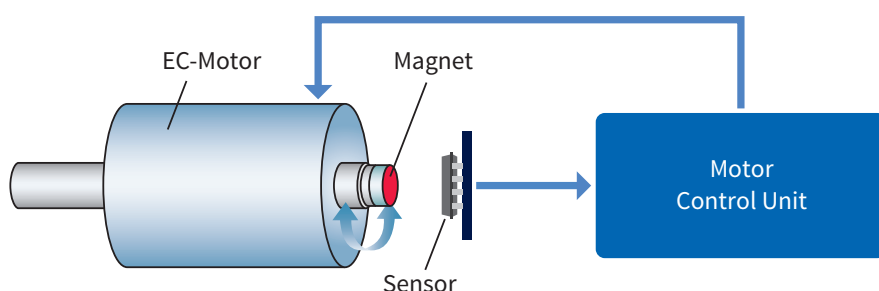



As correct commutation of the EPS motor has to be ensured in order to avoid blocked steering or erratic steering support, this application is also rated ASIL-D. To achieve this high level of functional safety, Infineon offers angle sensors in the dual-sensor package that allow the integration of two redundant sensors in the place of one.

The TLE5309D, in particular, meets the highest functional safety requirements by using a combination of AMR (Anisotropic-Magneto-Resistance) and GMR (Giant-Magneto-Resistance) technology, which not just offers redundancy, but also integrated diversity in a single product.

Depending on the overall EPS system architecture, the motor position sensor can be directly mounted on the steering ECU, or connected via a cable in a satellite configuration.

The very high level of sensor accuracy required for highest energy efficiency, comparable to the performance of costly resolver solutions, is typically achieved by implementing a continuous calibration algorithm on the steering ECU. By monitoring the sensors output signals and calculating the compensation parameters during operation, this algorithm compensates any drift errors that occur over temperature and lifetime.

	<b>TLE5009(D)</b> Fast dual-GMR angle sensor with analog Sin/Cos output to support on-ECU designs. Available in a 16-pin dual-sensor SMD package.
	<b>TLE5012BD</b> Digital GMR angle sensor with SPI + incremental encoder interface or Hall switch emulation output to support on-ECU and satellite designs. Available in a 16-pin dual-sensor SMD package.
	<b>TLE5309D</b> <b>Combined AMR and GMR sensor for integrated diversity</b> , featuring fast analog Sin/Cos output to support on-ECU designs. Available in a 16-pin dual-sensor SMD package.



## 2-Wheeler and All-Terrain Vehicles

Our broad portfolio of Hall- and GMR-based sensors is ideal for motorcycle, three-wheel and all terrain vehicle applications. These solutions cover the full spectrum from switching through position measurement to engine and vehicle speed measurement, ABS sensing included. [www.infineon.com/sev](http://www.infineon.com/sev)



---

## Commercial Vehicles

We offer a broad portfolio of highly robust magnetic sensors tailored to the specific needs of commercial vehicles such as trucks or busses. Our Hall and xMR-based sensors were developed for switching functions as well as position and speed measurement. You are bound to find a dedicated solution for the individual body, powertrain and safety system of your commercial vehicle. [www.infineon.com/truck](http://www.infineon.com/truck)



# Sensors in Industrial Applications

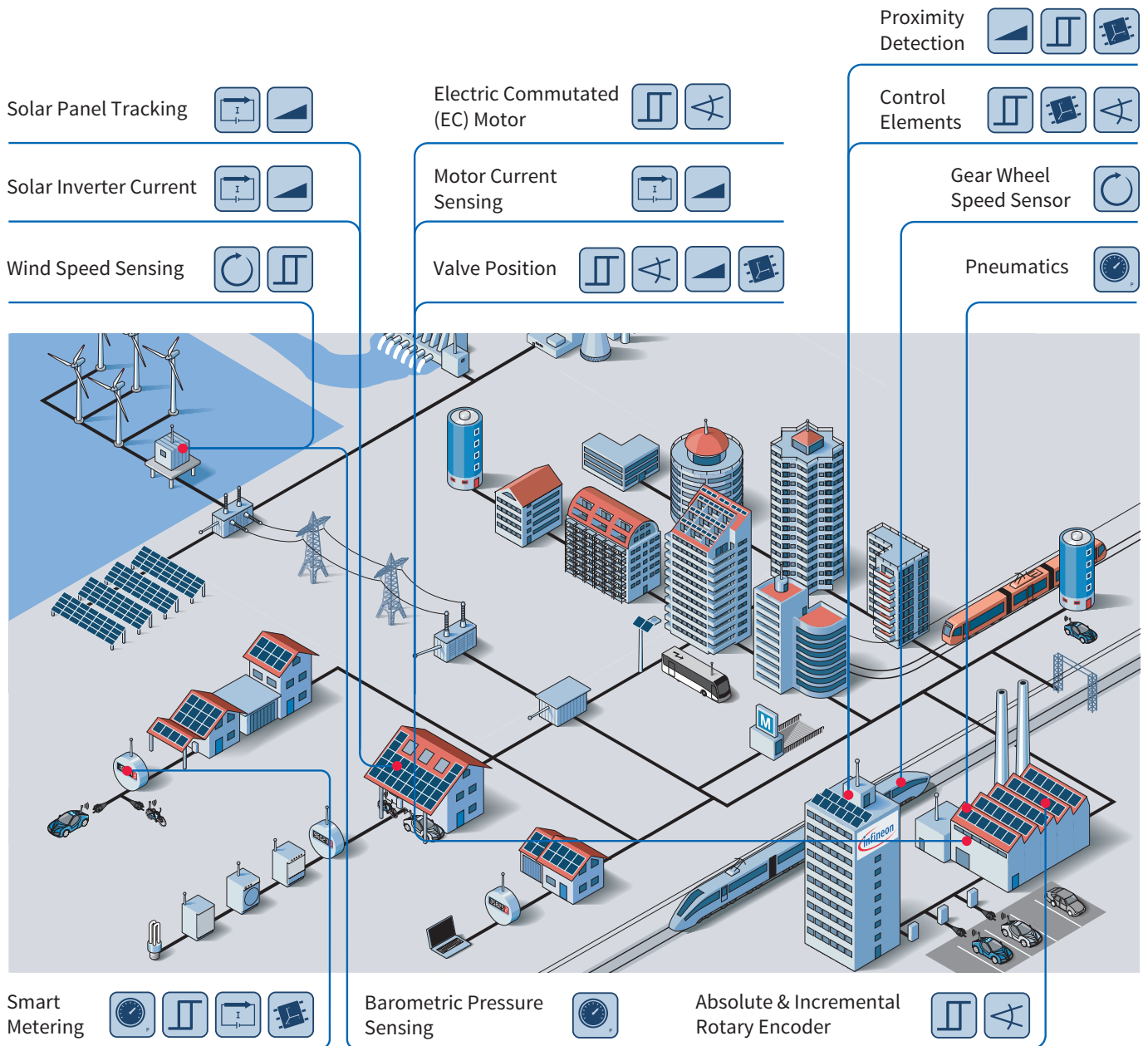

Switches
 Linear Hall
 Angle Sensors
 Current Sensors
 Speed Sensors
 Pressure
 3D Magnetic Sensors

We develop sensors for a wide range of industrial applications, including renewable energy, industrial automation and e-mobility. Our offering here includes products such as magnetic position and speed sensors as well as integrated pressure sensors, current sensors and 3D magnetic sensors. In the case of electric drives – a key area in industrial applications – our portfolio comprises a full range of energy-saving sensors for electric commutated drives. In the increasingly important solar sector, our current sensors help our customers achieve optimum system efficiency and meet country-specific regulations.

# Sensors for Industrial/Home Applications

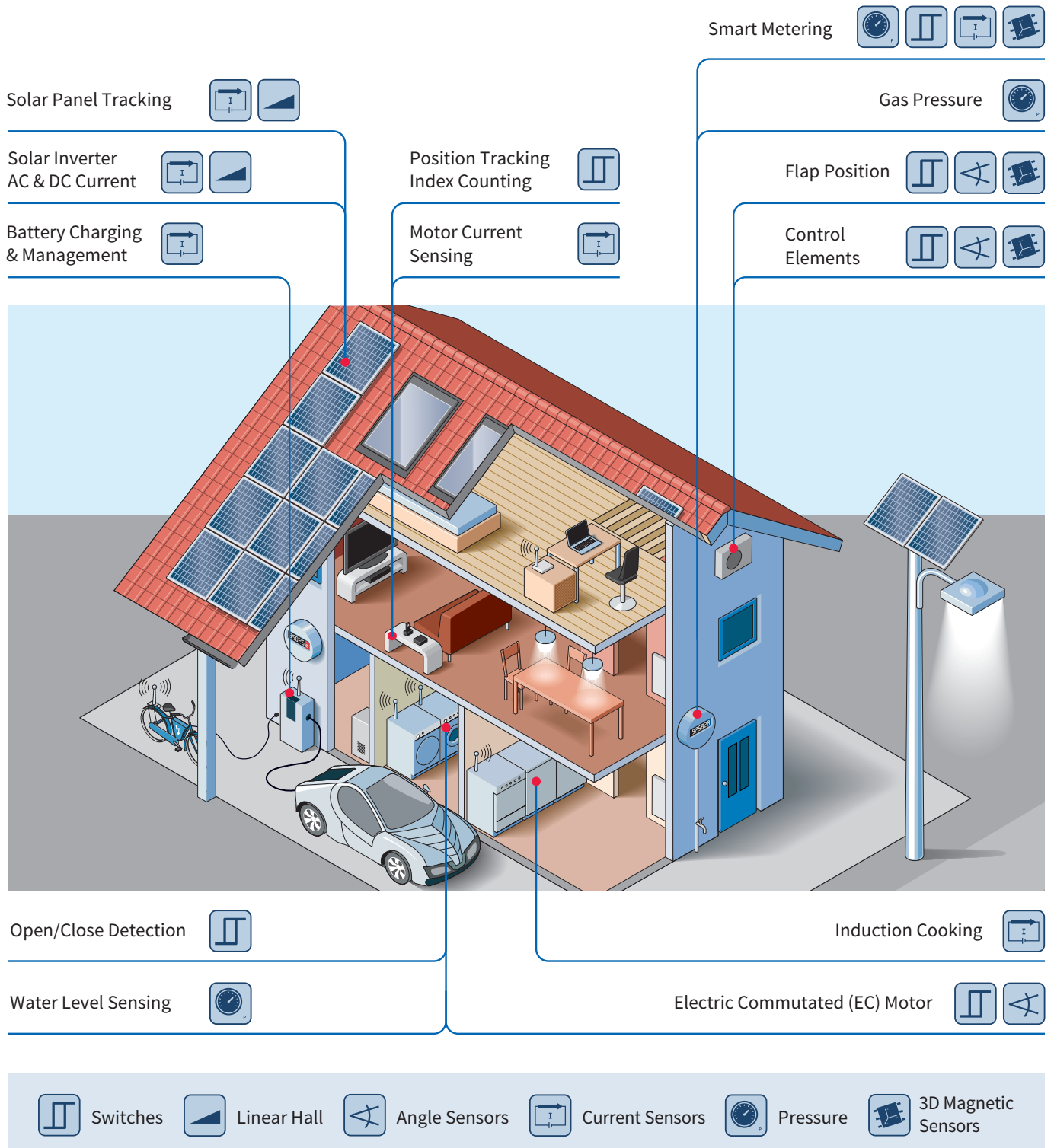

Our broad and deep sensor offering provides the perfect fit for various industrial/home applications, including renewable energy, white goods, home automation and power tools. In the home appliances sector, electric commutated BLDC drives are being increasingly used to reduce overall power consumption. We offer a competitive range of position sensors such as Hall switches and angle sensors for reliable, energy-efficient motor commutation in BLDC drives. Our sensors are also used in applications such as smart metering, solar inverters and sun blinds.

# TLE49x6 Family

## High-Precision Hall Switches



The TLE49x6 family comprises high-precision, unipolar and bipolar Hall-effect switches as well as switches and latches for different magnetic sensitivities. TLE49x6 products have proven successful in many automotive and industrial applications. The family also includes two-wire sensors with a current interface as well as a low-power model that consumes just 4  $\mu$ A.

### Features

- Broad, successful family concept
- Best in class quality
- Chopped Hall system for high sensitivity
- High jitter performance
- SMD and leaded packages
- Open collector or current interface
- Low-power version available
- Temperature compensation
- Up to 18 V supply
- Dedicated products for industrial applications (TLI49x6)

### Applications

- Power closing (index counting)
- Gear stick (position detection)
- Seat belt (position detection)
- HVAC flap (position detection)
- BLDC commutation
- Two-wheeler applications

Product	Type	Operating Point $B_{OP}$	Release Point $B_{RP}$	Hysteresis $\Delta B_{HY}$	Automotive	Industrial	Package
TLE4906K/L	Unipolar switch	10.0	8.5	1.5	●	●	SC59/PG-SSO-3-2
TLE4906-2K	Unipolar switch	18.0	12.5	5.5	●	●	SC59
TLE4906-3K	Unipolar switch	28.0	22.5	5.5	●	–	SC59
TLE4946K	Latch	14.0	-14.0	28.0	●	●	SC59
TLE4946-1L	Latch	15.0	-15.0	30.0	●	–	PG-SSO-3-2
TLE4946-2K/L	Latch	2.0	-2.0	4.0	●	●	SC59/PG-SSO-3-2
TLE4976L	Unipolar Switch/ Current Interface	6.0	4.0	2.0	●	–	PG-SSO-3-2
TLE4976-1K	Unipolar Switch/ Current Interface	9.25	7.25	2.0	●	–	SC59
TLE4976-2K	Unipolar Switch/ Current Interface	4.5	2.7	1.8	●	–	SC59
TLE4916-1K	Low Power	3.5	-3.5	7.0	●	–	SC59

# TLE496x-xM/TLI496x-xM

## High-Precision Automotive/Industrial Hall-Effect Sensor for 5V Applications

TLE496x-xM/TLI496x-xM are integrated Hall-effect sensors specially designed for highly accurate applications. The sensors provide an easy-to-use and cost-effective solution for position sensing applications, requiring high temperature stability of the magnetic threshold.

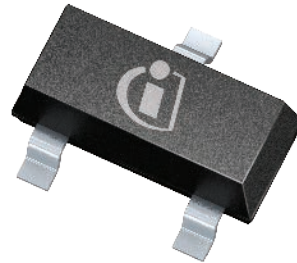

Target applications for TLE496x-xM/TLI496x-xM are all applications requesting a precision Hall latch or Hall switch with a broad operating temperature range.

By offering an excellent magnetic behavior Infineon's switches are ideally suited for:

- Index counting application with a pole wheel
- Rotor position detection (BLDC motors)
- Open/close detection

### Features

- 3.0 V to 5.5 V operating supply voltage
- Low current consumption 1.4 mA
- ESD protection 4 kV HBM
- Active error compensation (chopped)
- High stability of magnetic thresholds
- Low jitter (typ. 0.35  $\mu$ s)
- Operating temperature range:
  - from -40 °C to 170 °C (TLE496x-xM)
  - from -40 °C to 125 °C (TLI496x-xM)
- Small SMD package SOT23
- AEC-Q100 qualified

Product	Type	Operating Point $B_{OP}$	Release Point $B_{RP}$	Hysteresis $\Delta B_{HY}$	Automotive	Industrial	Package
TLE4963-1M	Latch	2.0	-2.0	4.0	●	●	SOT23
TLE4963-2M	Latch	5.0	-5.0	10.0	●	●	SOT23
TLE4965-5M	Unipolar switch	7.5	5.0	2.5	●	●	SOT23
TLI4963-1M	Latch	2.0	-2.0	4.0	–	●	SOT23
TLI4963-2M	Latch	5.0	-5.0	10.0	–	●	SOT23
TLI4965-5M	Unipolar switch	7.5	5.0	2.5	–	●	SOT23



# TLE496x-xM/L

## Energy-Efficient Hall Switch Family in the Smallest SOT23 Package

The new TLE496x-xM/L family of Hall switches saves energy and enables designers to create precise, compact systems. With an operational current consumption of just 1.6 mA, TLE496x-xM/L products can cut energy consumption by up to 50 percent compared with similar competitor products. Thanks to its small magnetic hysteresis, the family paves the way for precise switching points in systems. The integrated temperature profile compensates magnetic drifts and enables stable performance overtemperature and lifetime.

TLE496x-xM products come in the smallest SOT23 package, thus reducing height by 10 percent compared with predecessor products. The new sensors also feature an integrated functionality test for better system control.

### Features

- Current consumption of just 1.6 mA
- 3 to 32 V supply voltage range (over voltage up to 42 V)
- 7 kV ESD protection (HBM)
- Overtemperature and overcurrent protection
- Temperature compensation
- Smallest SOT23 package
- Dedicated products for industrial applications (TLI496x)

### Applications

- Window lifter (index counting)
- Power closing (index counting)
- Gear stick (position detection)
- Seat belt (position detection)
- BLDC (commutation)

### Block Commutation for BLDC Motors

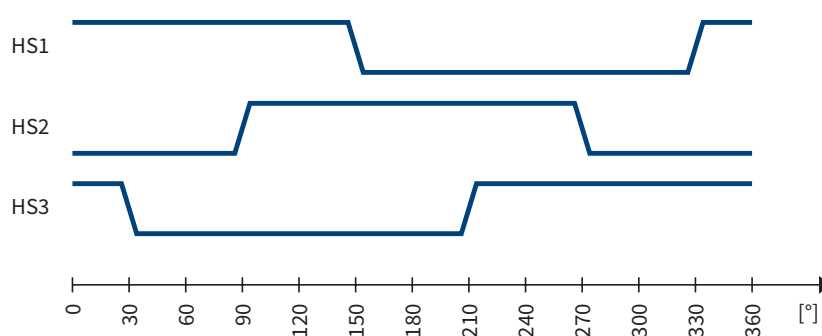
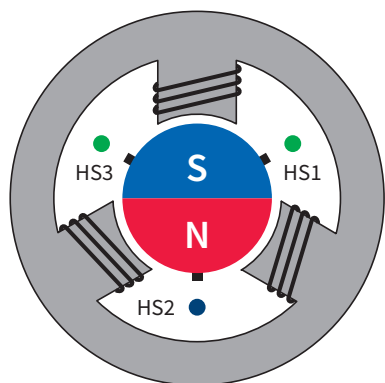

Product	Type	Operating Point $B_{OP}$	Release Point $B_{RP}$	Hysteresis $\Delta B_{HY}$	Automotive	Package
TLE4961-1M/L	Latch	2.0	-2.0	4.0	●	SOT23/PG-SSO-3-2
TLE4961-2M	Latch	5.0	-5.0	10.0	●	SOT23
TLE4961-3M/L	Latch	7.5	-7.5	15.0	●	SOT23/PG-SSO-3-2
TLE4964-1M	Switch	18.0	12.5	5.5	●	SOT23
TLE4964-2M	Switch	28.0	22.5	5.5	●	SOT23
TLE4964-3M	Switch	12.5	9.5	3.0	●	SOT23
TLE4964-5M	Switch	7.5	5.0	2.5	●	SOT23
TLE4968-1M/L	Bipolar	1.0	-1.0	2.0	●	SOT23/PG-SSO-3-2

# TLV496x-xTA/B

## Precision Hall-Effect Sensor for Consumer Applications

The TLV496x-xTA/B Hall sensor family comprises a line of Hall switches for contactless position sensing. The sensors are specially designed to provide an easy-to-use and cost-effective solution for position sensing applications.

### Features

- 3.0 to 26 V operating supply voltage
- Low current consumption 1.6 mA
- ESD protection 4 kV HBM
- Operating temperature range from -40 °C to 125 °C
- Leaded package PG-T092S

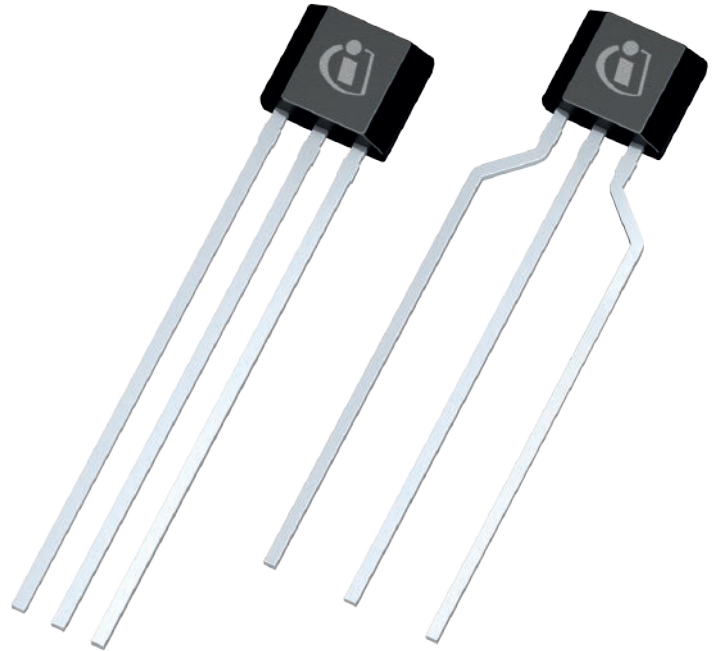

Product	Type	Operating Point $B_{OP}$	Release Point $B_{RP}$	Hysteresis $\Delta B_{HY}$	Automotive	Package
TLV4961-1TA	Latch	2.0	-2.0	4.0	●	PG-T092S-3-1
TLV4961-1TB	Latch	2.0	-2.0	4.0	●	PG-T092S-3-2
TLV4961-3TA	Latch	7.5	-7.5	15.0	●	PG-T092S-3-1
TLV4961-3TB	Latch	7.5	-7.5	15.0	●	PG-T092S-3-2
TLV4964-4TA	Unipolar switch	10.0	8.5	1.5	●	PG-T092S-3-1
TLV4964-4TB	Unipolar switch	10.0	8.5	1.5	●	PG-T092S-3-2
TLV4964-5TA	Unipolar switch	7.5	5.0	2.5	●	PG-T092S-3-1
TLV4964-5TB	Unipolar switch	7.5	5.0	2.5	●	PG-T092S-3-2
TLV4968-1TA	Latch	1.0	-1.0	2.0	●	PG-T092S-3-1
TLV4968-1TB	Latch	1.0	-1.0	2.0	●	PG-T092S-3-2

# TLE4966

## Two-In-One Double Hall Sensor

TLE4966 features two integrated, calibrated sensor elements for detecting direction and counting indexes. This two-in-one feature eliminates the need for a second sensor, which in turn cuts engineering and production costs. Using just one sensor also raises system quality and reliability.

### Features

- Two Hall probes
- Excellent matching between the two Hall probes
- Hall plate distance of 1.45 mm
- Industry standard
- Outstanding quality
- Information on direction and speed
- TSOP6 package

### Applications

- Window lifter
- Sunroof
- Door power closing

Product	Type	Operating Point $B_{OP}$	Release Point $B_{RP}$	Hysteresis $\Delta B_{HY}$	Automotive	Package
TLE4966K/L	Double Hall, speed and direction output	7.5	-7.5	15	●	TSOP6/PG-SSO-4-1
TLE4966-2K	Double Hall, two independent outputs	7.5	-7.5	15	●	TSOP6
TLE4966-3K	Double Hall, speed and direction output	2.5	-2.5	5	●	TSOP6
TLE4966V-1K	Vertical Double Hall, speed and direction output	2.5	-2.5	5	●	TSOP6

# TLE4966V

## Vertical Dual-Hall Sensor

### Features

- Saves space
- Easy mounting of sensor and PCB board
- Allows increased mounting flexibility
- Enables new, compact system designs

### Sensing Direction Parallel to Target to Wheel

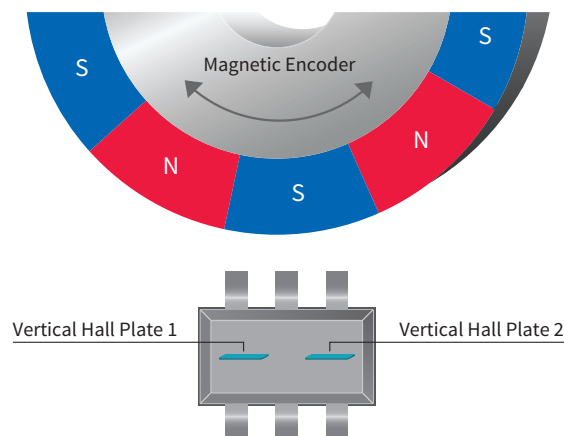

# 3D Magnetic Sensor

## TLV493D-A1B6 for Consumer and Industrial Markets



The TLV493D-A1B6 sensor offers accurate three-dimensional sensing with extremely low power consumption in a small 6-pin package. Capable of detecting the magnetic field in the x, y, and z-direction, the sensor is ideally suited for the measurement of:

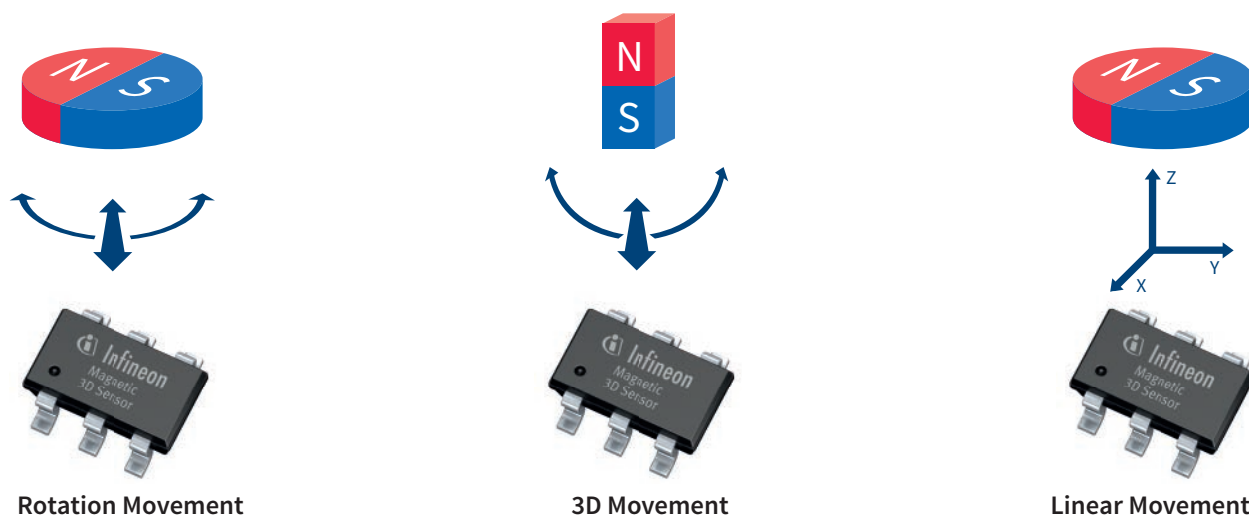

Thanks to its small package and low power consumption, the TLV493D-A1B6 can be used in new applications, replacing potentiometer and optical solutions. Featuring contactless position sensing and high temperature stability of the magnetic threshold, this system concept keeps getting smaller, more accurate and more robust.

The sensor provides a digital output via a 2-wire standard I<sup>2</sup>C interface, which enables a high communication speed and bidirectional communication between the sensor and microcontroller.

To enable customers' systems to fulfill the highest quality standards and various environmental regulations, the sensor is both RoHs compliant and JESD47 qualified.

### Features

- 3D magnetic sensing
- Integrated temperature sensing
- Low current consumption
  - 0.007  $\mu$ A in power-down mode
  - 10  $\mu$ A in ultra-low power mode
- 2.3 V to 3.5 V operating supply voltage
- Digital output via a 2-wire standard I<sup>2</sup>C interface
- B<sub>x</sub>, B<sub>y</sub> and B<sub>z</sub> linear field measurement up to  $\pm 150$  mT
- 12-bit data resolution for each measurement direction

- Resolution of 98  $\mu$ T/LSB
- Operating temperature range from -40 °C to 125 °C
- Interrupt signal available to wake-up a microcontroller
- TSOP6 package

### Applications

- E-Meters e.g. anti-tampering
- Joystick e.g. finger, thumb, hand joystick
- Control elements e.g. white goods, multifunction knob

Type	Temperature Range	Qualification	Package	Ordering Code	Samples	Start of Production
TLV493D-A1B6	-40 °C ... 125 °C	JESD47	TSOP6	SP001286056	Available	Q1 2016

Samples of automotive-qualified TLE493D-A1B6 will be available by Q4/2015.

# TLE499x Family

## Programmable Analog/Digital Linear Hall Sensor Family



Our family of TLE499x linear Hall ICs is tailored to the needs of highly accurate angular and linear position detection and current measurement applications. Each product measures the vertical component of a magnetic field and outputs a signal that is directly proportional to the magnetic field. These programmable linear Hall sensors come with different interface options: TLE4997 features radiometric analog output while TLE4998P comes with pulse width modulation (PWM), TLE4998S with Single Edge Nibble Transmission (SENT) and TLE4998C with Short PWM Codes (SPC). These high-precision 12-bit resolution linear Hall sensors feature EEPROM memory for flexible programming across a wide range of parameters.

Thanks to digital signal processing based on a 20-bit DSP architecture plus digital temperature compensation, these sensors deliver outstanding temperature stability compared with similar compensation methods. TLE4998 also includes stress compensation to withstand stress effects from the package, such as moisture, thus ensuring best-in-class accuracy over the device's lifetime.

### Features

- Best-in-class accuracy with low drift of output signal overtemperature and lifetime (including stress compensation in TLE4998)
- Programmable transfer function (gain, offset), clamping, bandwidth and temperature characteristics
- AEC-Q100 qualified
- Available in various packages including PG-SSO-3-9 with two integrated capacitors to improve ESD and ESC behavior
- Dual-die SMD package

### Applications

- Detecting linear and angular position
- Detecting pedal and throttle position
- Steering torque measurement
- Headlight leveling
- High-current sensing
- Seat position and occupant detection
- Suspension control
- Detecting gear stick/lever positions
- Detecting liquid levels in fuel tanks
- Battery management
- Motor control

Product	Programmable	Number of Pins	Sensitivity	Magnetic Offset	Supply Voltage (extended range)	Automotive	Interface	Package
TLE4997	EEPROM	3	±12.5 to ±300 mV/mT	< ±400 μT	5 V ±10% (7 V)	●	Analog	PG-SSO-3-10 PG-TDSO-8
TLE4998P	EEPROM	3/4	±0.2 to ±6%/mT	< ±400 μT	5 V ±10% (16 V)	●	PWM	PG-SSO-3-10 PG-SSO-4-1 PG-SSO-3-9 (2 Capacitors) PG-TDSO-8
TLE4998S	EEPROM	3/4	±8.2 to ±245 LSB/mT	< ±400 μT	5 V ±10% (16 V)	●	SENT	PG-SSO-3-10 PG-SSO-4-1 PG-SSO-3-9 (2 Capacitors) PG-TDSO-8
TLE4998C	EEPROM	3/4	±8.2 to ±245 LSB/mT	< ±400 μT	5 V ±10% (16 V)	●	SPC	PG-SSO-3-10 PG-SSO-4-1 PG-SSO-3-9 (2 Capacitors) PG-TDSO-8

1) More information on PRO-SIL™, see page 49



# Dual-Sensor Package



## Two Sensors in One SMD Package

The new SMD package (PG-TDSO) includes two independent sensors with separate power supply and separate signal outputs. Due to special mounting technology, Infineon is able to keep dual-sensor package size very small to enable compact PCB layouts and small magnet sizes.

Infineon offers linear Hall sensors or angle sensors in the PG-TDSO package. The two sensors in one package offer sensor redundancy in one package. Sensor redundancy is especially interesting for new generation EPS steering systems with increased ISO 26262 requirements and other safety critical applications. All sensors are automotive qualified.

Most products are also available as single-sensor solution with only one sensor.

### Features

- Two sensors in one package
- Separate power supply and signal output
- Automotive qualified
- Temperature range from -40 °C to +125 °C
- Outstanding quality
- Linear Hall or angle sensor available
- Single-sensor versions available
- 16-pin and 8-pin versions available

### Automotive Applications

- Steering torque systems
- Steering angle systems
- Pedal position
- Brushless DC motor (e.g. EPS motor, transmission & clutch actuator)

### Linear Halls

Product	Interface	Dual-/Single-Sensor Available	Package
TLE4997A8D	Analog	yes/yes	PG-TDSO-8
TLE4998P8D	PWM	yes/yes	PG-TDSO-8
TLE4998S8D	SENT	yes/yes	PG-TDSO-8
TLE4998C8D	SPC	yes/yes	PG-TDSO-8

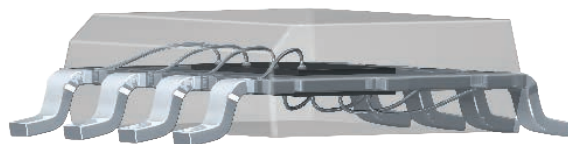

# TLE5012BD

## iGMR Sensor with Integrated Angle Calculation and Multiple Interfaces



### Features

- Integrated angle calculation with CORDIC algorithm
- 15-bit representation of calculated angle value
- High update rate up to 43  $\mu$ s (23 kHz)
- Range of selectable interfaces
- SPI-compatible synchronous serial communication (SSC)
- Bi-directional communication up to 8 Mbit/s
- Pulse Width Modulation (PWM)
- Hall Switch Mode (HSM) for motor commutation
- Incremental interface (IIF)
- Temperature compensation and auto-calibration algorithm
- Diagnostic function for sensor elements and circuitry with PRO-SIL™ support
- Dual-die SMD package
- Redundancy

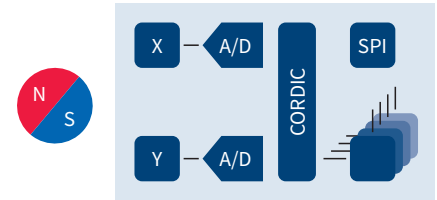

### Applications

- Steering angle
- Brushless DC motor commutation (for example Electric Power Steering (EPS))
- Rotary switches
- General angular sensing
- Incremental or absolute magnetic encoders

# TLE5309D

## Diverse iAMR & iGMR Sensor with Analog Interface



### Features

- Differential or single-ended analog interface for sine and cosine values
- Internal temperature drift compensation for gain and offset
- Dual-die sensor with technology diversity

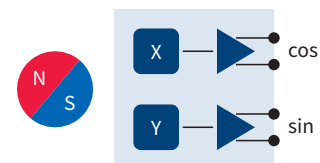

### Applications

- Contactless angle measurement
- Steering angle
- Motor commutation
- Wiper position
- Rotational position measurement

### Angle Sensors

Product	Technology	Interface	Package
TLE5012BD	GMR	SPI/IIF/SPC	PG-TDSO-16
TLE5309D	GMR and AMR	Analog sin/cos	PG-TDSO-16
TLE5009D	GMR	Analog sin/cos	PG-TDSO-16



1) More information on PRO-SIL™, see page 49

# Angle Sensors



We offer a family of angle sensors based on integrated Magneto Resistive (ixMR) technologies. The sensors detect the orientation of an applied magnetic field by measuring sine and cosine angle components with monolithically integrated magneto resistive elements. ixMR technology is now widely used in automotive and industrial applications and provides a wide range of benefits.

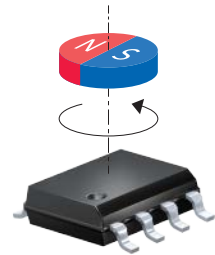

**Low sensitivity to air gap variations:** The ixMR element senses a field's direction, not its intensity. Variations in field intensity within the sensor's range therefore have a minimal impact on angle accuracy.

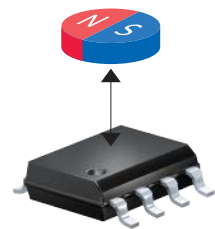

**Improved tolerance to misalignment:** The area sensitive to ixMR is very small. It is therefore easier to keep it within the homogeneous zone of the magnetic field, in case of a small mechanical failure.

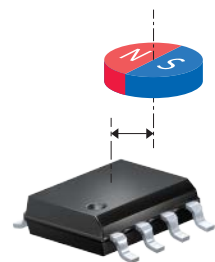

**High speed:** ixMR technology is extremely fast. Its speed is not limited by the reaction time of the MR element but by delays in the amplifier circuit.



**High degree of integration:** The data processing and communication interfaces are integrated in the same silicon chip as the sensing elements. This enables compact designs using small outline packages. The angle sensors are available with a wide variety of communication interfaces as well as different levels of data processing and self-testing capabilities, making them ideal for safety-relevant applications in the automotive sector.

# iGMR Sensors



Our iGMR sensors are ideal for applications with a wide angle range, for example BLDC motor or steering sensors. They are pre-calibrated and ready to use. Different levels of signal processing integration enable designers to optimize system partitioning.

## TLE5009



### Analog iGMR Sensor with Temperature Compensation

TLE5009 features a differential or single-ended analog interface for sine and cosine values as well as internal temperature drift compensation for gain and offset. Also available as Dual-Sensor package.

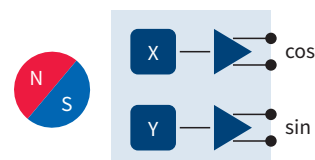

## TLE5011



### iGMR Sensor with Digital Interface

#### Features

- 16-bit representation of sine/cosine values on the interface
- Bi-directional SSC (SPI-compatible) interface up to 2 Mbit/s
- Diagnostic function for sensor elements and circuitry with PRO-SIL™ support

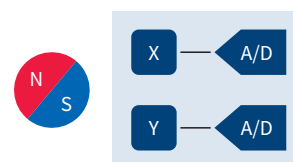

## TLE5012B



### iGMR Sensor with Integrated Angle Calculation and Multiple Interfaces

#### Features

- Integrated angle calculation with CORDIC algorithm
- 15-bit representation of calculated angle value
- High update rate up to 43  $\mu$ s (23 kHz)
- Range of selectable interfaces
- SPI-compatible synchronous serial communication (SSC)
- Bi-directional communication up to 8 Mbit/s
- Pulse Width Modulation (PWM)
- Hall Switch Mode (HSM) for motor commutation
- Incremental interface (IIF)
- Temperature compensation and auto-calibration algorithm
- Diagnostic function for sensor elements and circuitry with PRO-SIL™ support

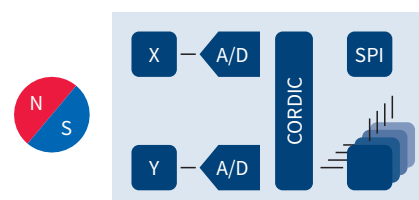

#### Applications

- Steering angle
- Brushless DC motor commutation (for example electric power steering, EPS)
- Rotary switches
- General angular sensing
- Incremental or absolute magnetic encoders

Device	Technology	Sin/Cos Output	Angle Output	Second Interface	Accuracy	Automotive	Industrial
TLE5009	GMR	Analog	-	-	2.3°	•	•
TLE5011	GMR	SSC (SPI)	-	-	1.6°	•	•
TLE5012B	GMR	SSC (SPI)	SSC (SPI)	PWM/IIF/SPC/HSM	1.0°	•	•

1) More information on PRO-SIL™, see page 49



# Magnetic Speed Sensors



Our Hall- and GMR-based magnetic speed sensors are designed to measure speed in safety and powertrain applications such as speedometers, ABS, camshafts/ crankshafts and automatic transmissions. They are also used in similar applications in the industrial sector. The sensors use a ferromagnetic gear tooth or encoder structure to measure linear or rotational speed and position. Hall sensor measuring rotational speed with a gear tooth and a magnetic encoder wheel.

We offer a broad range of options to ensure the perfect fit for individual customer applications, including voltage and current interfaces with optional current detection or vibration suppression. By integrating the magnetic Hall or GMR sensing cell and the signal processing unit on a single chip, we deliver optimum performance and cost savings.

The majority of sensors also feature additional benefits such as integrated capacitors (C- types) for high EMC robustness and the highest levels of ESD protection. Our sensors also come in a range of innovative package designs with integrated back-bias magnets (iBB package).

We have an outstanding record of excellence in the automotive sector. Over two billion of our integrated magnetic sensors are installed in cars all over the world, delivering extremely reliable results in safety-relevant applications such as ABS, and in extremely harsh environments such as engines and transmissions.

# The Speed Sensing Family



Product	Automotive	Industrial	Sensor Technology	AEC-Q100 Qualified	RoHS	HAL Free	Product Status
TLE4921	•	•	Differential Hall	•	•	•	In Production
TLE4922	•	•	Mono-Hall	•	•	•	Coming Soon
TLE4924	•	•	Differential Hall	•	•	•	In Production
TLE4926	•	-	Differential Hall	•	•	•	In Production
TLE4927	•	•	Differential Hall	•	•	•	In Production
TLE4928	•	-	Differential Hall	•	•	•	In Production
TLE4941	•	-	Differential Hall	•	•	•	In Production
TLE4941plusC	•	-	Differential Hall	•	•	•	In Production
TLE4942	•	-	Differential Hall	•	•	•	In Production
TLE4951	•	•	Differential Hall	•	•	•	In Production
TLE4953	•	-	Differential Hall	•	•	•	In Production
TLE4954	•	•	Differential Hall	•	•	•	In Production
TLE4957	•	•	Differential Hall	•	•	•	In Production
TLE4983	•	-	Mono-Hall	•	•	•	In Production
TLE4984	•	-	Mono-Hall	•	•	•	In Production
TLE4986	•	-	Mono-Hall	•	•	•	In Production
TLE5025	•	-	iGMR	•	•	•	In Production
TLE5027	•	-	iGMR	•	•	•	In Production
TLE5041plusC	•	-	iGMR	•	•	•	In Production

## Typical Application of a Magnetic Differential Sensor

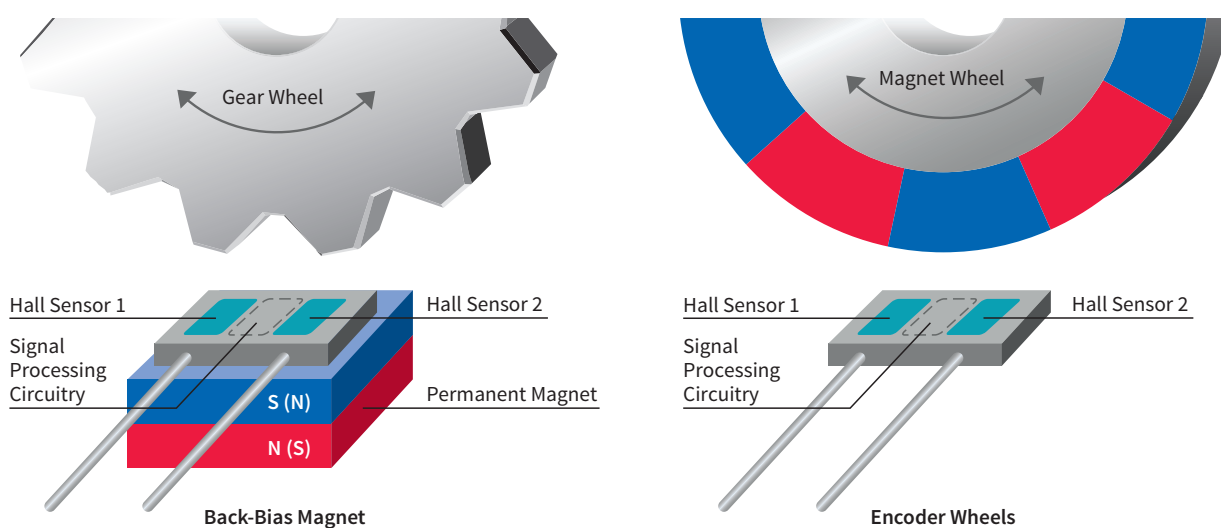



# Overview of Powertrain Speed Sensors

	Icon/Description	TLE4921	TLE4922	TLE4924	TLE4926	TLE4927	TLE4928	TLE4941
Automotive	Wheel Speed	-	•	-	-	-	-	•
	Camshaft	-	•	•	-	•	-	-
	Crankshaft	•	•	•	•	•	•	-
	Transmission	•	•	•	-	•	•	•
Industrial		•	•	•	-	•	•	-
Sensor Technology		Diff. Hall	Mono-Hall	Diff. Hall	Diff. Hall	Diff. Hall	Diff. Hall	Diff. Hall
Improved Air Gap/ Jitter Performance		-	-	-	-	-	-	-
Direction Information Available		-	-	-	-	-	-	-
True Power On (TPO)		-	-	-	-	-	-	-
Twist-Independent Mounting (TIM)		-	•	-	-	-	-	-
Vibration Suppression Algorithm Included		-	-	-	-	-	-	-
Type of Hysteresis <sup>1)</sup>		V	H	V	H	H	H	H
		F	A	A/F	F	A	F	F
Interface <sup>2)</sup>	# of pins	4	4	3	3	3	3	2
	Interface	V	V	V	V	V	V	C
	Protocol	S	P	S	S	S	S	S
Electrostatic Discharge (ESD)	Human Body Model (HBM)	2 kV	4 kV	6 kV	6 kV	6 kV	6 kV	12 kV
Package without Integrated Capacitor		•	•	-	-	-	•	•
Package with Integrated Capacitor		-	-	•	•	•	•	-
iBB-Package		-	-	•	-	•	-	-

1) H = Hidden; V = Visible; F = Fixed; A = Adaptive; P = Programmable

2) C = Current; V = Voltage Interface; S = Single Pulse; P = PWM Protocol

TLE4941plusC	TLE4942	TLE4951	TLE4953	TLE4954	TLE4957	TLE4983	TLE4984	TLE4986	TLE5025	TLE5027	TLE5041plusC
•	•	-	-	-	-	-	-	-	-	-	•
-	-	-	-	-	-	•	•	•	•	-	-
-	-	-	-	-	•	-	-	-	•	•	-
•	•	•	•	•	•	-	-	-	•	•	-
•	-	•	•	•	•	-	-	-	-	-	-
Diff. Hall	Diff. Hall	Diff. Hall	Diff. Hall	Diff. Hall	Diff. Hall	Mono-Hall	Mono-Hall	Mono-Hall	iGMR	iGMR	iGMR
-	-	-	-	-	-	-	-	-	•	•	•
-	•	-	•	•	-	-	-	-	-	•	-
-	-	-	-	-	-	•	•	•	-	-	-
-	-	-	-	-	-	•	•	•	-	-	-
-	-	•	•	•	•	-	-	-	-	-	-
H	H	V	V	V	V/H	H	H	V/H	H	H	H
F	F	A	A	A	A	F	F	P/A	A	A	A
2	2	2	2	2	3	3	3	3	3	3	2
C	C	C	C	C	V	V	V	V	V	V	C
S	P	P	P	P	S	S	S	S	S	P	S
12 kV	12 kV	12 kV	12 kV	12 kV	6 kV	4 kV	4 kV	6 kV	8 kV	8 kV	8 kV
-	-	-	•	•	-	-	-	-	-	-	-
•	•	•	•	•	•	•	•	•	•	•	•
•	-	•	-	•	•	-	-	•	-	-	-

# Integrated Back-Bias Magnet (iBB)

## Package for Magnetic Speed Sensors



Our innovative PG-SSOM-x-x package solution with an integrated back-bias (iBB) magnet is ideal for speed and position sensing applications that use ferromagnetic structures, for example gear wheels. This iBB package solution builds on our wealth of expertise in semiconductor manufacturing to deliver an extensive suite of benefits that reduces design effort and saves both time and costs.

With our extensive portfolio, we have the right solution and iBB package for a host of applications such as ABS, camshafts/ crankshafts and transmissions.

### Features

- Extremely precise magnet shaping and magnet-to-sensor positioning for optimized sensor performance
- No special expertise required in magnetic circuit design for applications that carry out sophisticated speed and positioning measurements (camshafts, magneto resistive sensors)
- Good fit for welding and soldering processes
- Small iBB package size
- Cost-effective solution
- Easy to use

### Applications

- Wheel speed (e.g. 2-wheeler)
- Camshafts/crankshafts
- Transmission
- Industrial speed and position sensing

### Gear Wheel Application with a Back-Bias Magnet

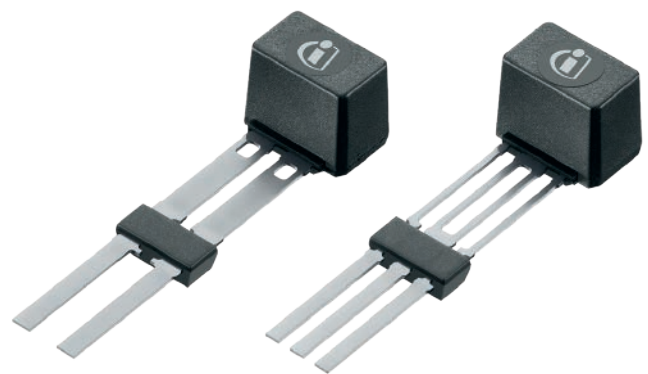
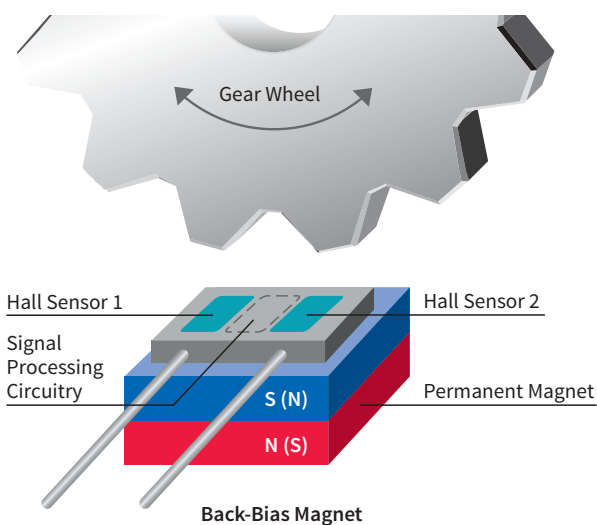

# TLE4921-5U

## Highly Robust and Cost-Effective Speed Sensor



TLE4921-5U is a highly robust and cost-effective solution for measuring speed in a wide range of automotive and industrial applications. This differential Hall sensor delivers outstanding performance while enabling simple, low-cost magnetic circuit designs, making it ideal for all entry-level speed sensing applications.

### Features

- Good sensing performance and high sensitivity
- Well suited to harsh environments thanks to dynamic offset cancelation, EMI robustness, reverse polarity and overvoltage protection

- Suitable for a broad temperature range
- Flexible sensor module interface that can be configured for two-wire and three-wire interfaces
- AEC-Q100 qualified

### Applications

- Engine speed and position (e.g. crankshaft)
- Transmission speed
- Speedometer
- Industrial speed and position sensing

# TLE4922

## Highly Robust, Easy-to-Use Mono-Hall Speed Sensor with Twist-Independent Mounting

This sensor is specially designed to provide an easy-to-use, robust and cost-effective solution for vehicle or industrial speed sensing applications. The TLE4922 can therefore be back-biased using a simple, low-cost bulk magnet, while providing a good air gap performance and switching accuracy. Its hidden adaptive hysteresis and calibration algorithm enables good accuracy over air gap jumps and immunity to vibration and run-out events.

Thanks to its mono-cell design, the TLE4922 is the perfect choice for applications requiring twist-independent mounting. As a result, the TLE4922 is well suited for replacing passive sensors, such as Variable Reluctance Sensors (VRS), in automotive and 2-wheeler applications by providing the user with higher accuracy and a better jitter performance.

The improved EMC, ESD and temperature robustness are perfectly suited for use in the harsh environmental conditions prevalent in automotive or dedicated industrial applications. The TLE4922 comes in a thin 4-pin PG-SSO-4-1 package using a standard 3-wire voltage interface.

### Features

- Large operating air gap capability
- Twist-independent mounting
- Hidden adaptive hysteresis
- Low current consumption
- Reverse magnetic polarity capability
- Advanced protection technology
  - Reverse voltage protection at Vs-pin
  - Short-circuit protection
  - Overtemperature protection
- Wide operating temperature ranges of  $-40\text{ °C} \leq T_j \leq \pm 150\text{ °C}$
- High ESD robustness up to  $\pm 4\text{ kV HBM}$
- 3-wire PWM voltage interface

### Applications

- 2-wheeler
- Automotive vehicle speed
- Industrial applications

# TLE4924/26/27/28C

## High-Performance Speed Sensor Family

Our proven family of TLE492x differential Hall speed sensors is designed for a broad range of speed sensing applications. Each sensor provides the highest levels of quality, robustness and cost efficiency. Thanks to the hysteresis and dynamic selfcalibration algorithm, they are ideally suited to high-performance speed sensing applications in harsh environments, such as automotive engine or transmission applications.

All sensors have a three-wire voltage interface, fast start-up time, symmetrical switching thresholds and optional south or north pole pre-induction.

### Features

- High sensitivity and large operating air gaps
- Excellent switching performance down to a 1 Hz cut-off frequency
- Broad operating temperature range
- High protection against reverse voltage, short circuit and overtemperature
- Strong EMC robustness and micro-cut performance thanks to module-style package with integrated 47 nF/4.7 nF capacitors
- Option to use innovative iBB package solution
- AEC-Q100 qualified

### Applications

- Engine speed and position (i.e. crankshaft)
- Transmission speed
- Speedometer
- Industrial speed and position sensing

Type	Hysteresis	Comment	Standard	iBB
TLE4924C-1	Visible fixed	-	PG-SSO-3-9	-
TLE4924C(B)-2	Visible adaptive	-	PG-SSO-3-9	PG-SSOM-3-11
TLE4926C	Hidden fixed	-	PG-SSO-3-9	-
TLE4926C-HT	Hidden fixed	High temperature profile	PG-SSO-3-9	-
TLE4927C(B)	Hidden adaptive	-	PG-SSO-3-9	PG-SSOM-3-11
TLE4928C	Hidden fixed	200 ms watchdog reset	PG-SSO-3-9	-

# Safety First: Infineon Wheel Speed Sensors

Nowadays, wheel speed sensors are confronted with an ever-growing list of questions and requirements. Years ago, ABS systems simply needed to know if a wheel was blocked, and then ESC used the accurate speed of all four wheels for its corrections. Since then, an increasing number of modules in the car take the wheel speed into account for their intelligent functions. The electrical parking brake, for example, needs to know about every inch a car moves when it's supposed to be stationary, and iTPMS uses sophisticated algorithms to determine if a wheel lacks air pressure, and even the central locking locks the doors after a couple of meters and the radio turns up the volume in line with increasing speed. All of the above rely on accurate information from the wheel speed sensor.

Currently, one out of every two cars worldwide uses our wheel speed sensors for these vital, safety-relevant tasks – over 1 billion Infineon wheel speed sensors have been sold over the past decade and contributed every day to make people's lives safer.

## Features

- High sensitivity for large air gap applications
- Differential principle against stray fields and other disturbances
- Single-chip solution for outstanding reliability
- Best-in-class slim package sets a global benchmark for the smallest-possible size of the sensor module
- High resistance against temperature change: No unwanted pulses at thermal drift
- Integrated 1.8 nF over-molded capacitor enhances EMC & micro-break resistance without the need for external components

## Applications

- Wheel speed sensing in automotive applications
- Antilock Braking Systems (ABS)
- Electronic Stability Programs (ESP)
- Automatic transmissions
- iTPMS (TLE5041plusC)

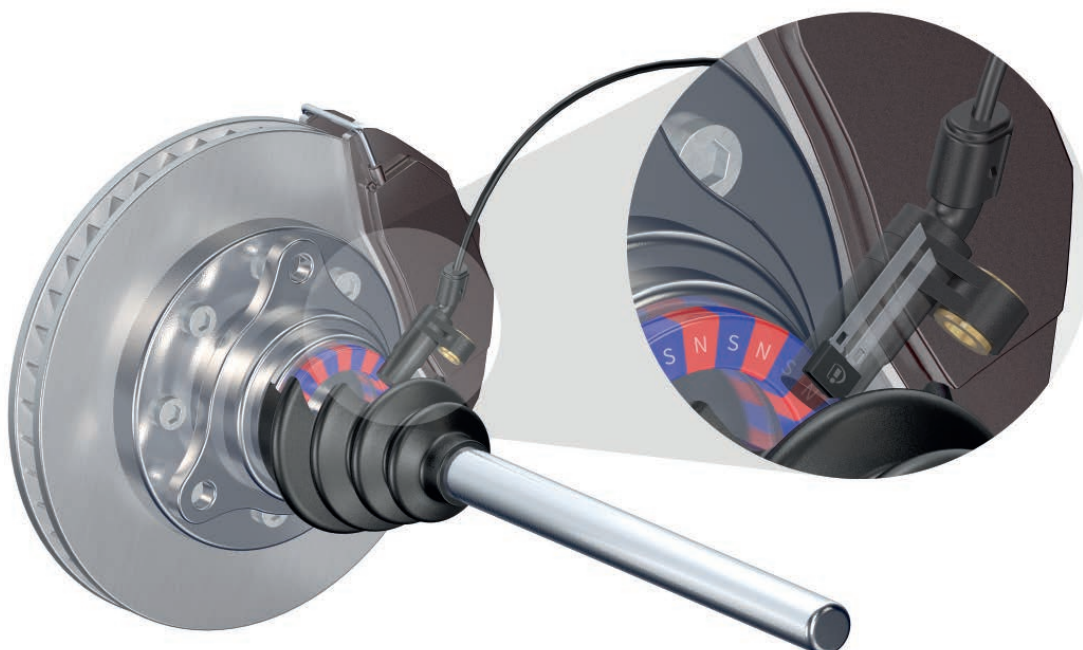



# TLE4941plusC(B)

## My Car – How Fast, Far and Where Does it Go?

The TLE4941plusC, our absolute top performer, has become an industry standard for wheel speed sensing.

As a single chip differential Hall Sensor, it magnetically measures the car's wheel speed; its Hall technology makes it the ideal all-purpose sensor, equally suitable for pole wheel and back-bias applications. The TLE4941plusC's differential principle makes it immune to any kind of undesired magnetic stray fields, ferromagnetic particles or other disturbances. Based on the latest sensor technologies for front- and back-end systems, the TLE4941plusC will remain standard for many years to come.

### Features

- Suitable for both pole wheels and tooth wheels
- Hall technology with clear advantages over MR technologies for back-bias wheel speed applications
- Also available with an integrated magnet package (iBB): TLE4941plusCB

TLE4941plusC Block Diagram

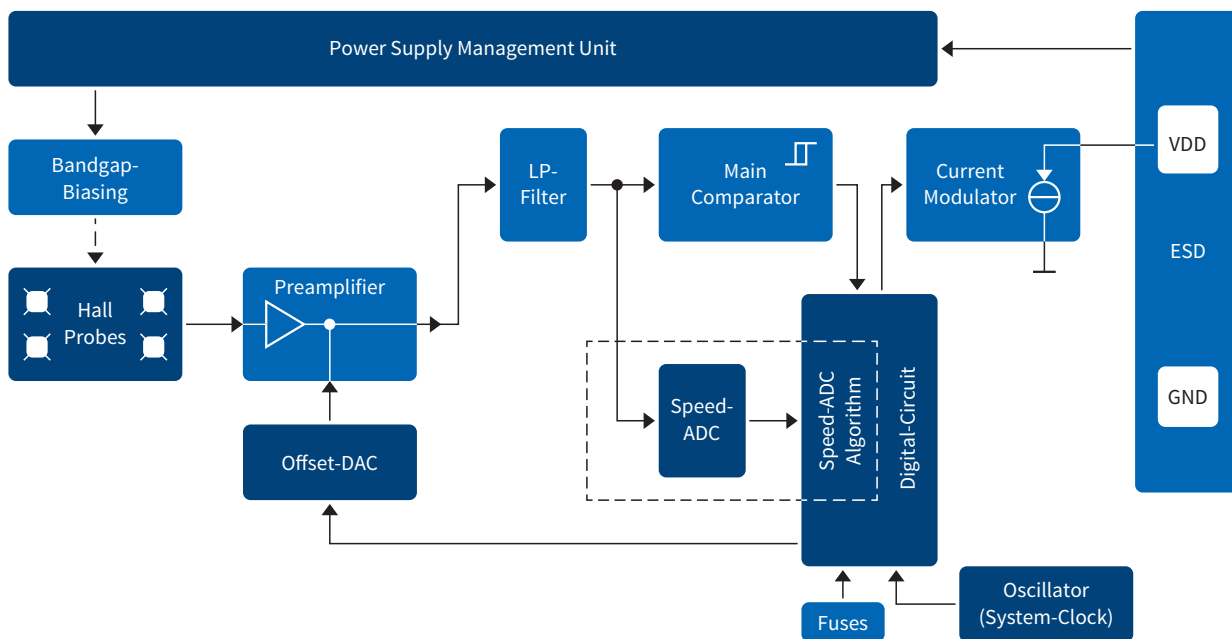

# TLE5041plusC

## Are the Tires Still in Good Condition?

The latest generations of iTPMS often have higher jitter requirements. In order to meet these requirements, we have developed the TLE5041plusC, which has the basic functionality of the TLE4941plusC, but uses the GMR effect to sense the wheel speed, as GMR yields better jitter than Hall.

### Features

- Best-in-class operating air gap at very low jitter, suitable for iTPMS

### Applications

- Pole wheel applications

## Overview of Wheel Speed Sensors

Type	Comment	Automotive	Package
TLE4941	Differential sensor for wheel speed	●	PG-SSO-2-1
TLE4941C	As TLE4941 plus integrated capacitor	●	PG-SSO-2-4
TLE4941-1	As TLE4941 plus first-edge detection	●	PG-SSO-2-1
TLE4941-1C	As TLE4941-1 plus integrated capacitor	●	PG-SSO-2-4
TLE4942-1	Includes direction detection, air gap warning and assembly position diagnosis	●	PG-SSO-2-1
TLE4942-1C	As TLE4942-1 plus integrated capacitor	●	PG-SSO-2-4
TLE4941plusC	Successor to the TLE4941 family and current top performer	●	PG-SSO-2-53
TLE4941plusCB	As TLE4941plusC plus integrated back bias	●	PG-SSOM-2-11
TLE5041plusC	Next-generation wheel speed sensor plus improved sensitivity and low jitter	●	PG-SSO-2-53

# TLE4953C

## The Two-Wire Transmission Speed Sensor

The differential Hall sensor TLE4953C can detect direction and was developed specifically to meet the needs of high-end transmission applications. Its jitter performance and high sensitivity enables designers to create high-accuracy systems with excellent vibration suppression. Adaptive hysteresis and the dynamic self-calibration algorithm ensure outstanding measurement results with both fine and coarse target wheels. As with other Infineon speed sensors, the south and north poles can be pre-inducted. TLE4953 features a current interface and comes in a two-wire package with an integrated 1.8 nF overmolded capacitor for improved EMI.

### Features

- Detection of rotation direction
- Highly accurate speed measurements from zero to 12 kHz over large operating air gaps
- Excellent vibration suppression
- Broad operating temperature range
- AEC-Q100 qualified

### Applications

- Automatic transmission systems
- Industrial speed sensing using current sensor interfaces

# TLE4951/54C(B)

## Leading the Way in Vibration Robustness

TLE4951/54 is a new family of differential Hall sensors specifically designed to meet the latest requirements in transmission vibration suppression. Each sensor provides best-in-class vibration suppression for applications that require a two-wire current interface. The TLE4951/54 family provides a similar algorithm plus dynamic self-calibration, jitter and sensitivity levels as our proven TLE4953, thus ensuring accurate speed measurements in the harshest of environments for both fine and coarse target wheels.

The TLE4951/54 speed sensor family provides the perfect fit every time. Designers can choose from a range of additional options to further customize their systems. TLE4954, for example, features direction detection. Different interface protocol versions of TLE4954 are also available as an integrated back-bias magnet package (iBB).

### Features

- Best-in-class vibration suppression
- Highly accurate speed measurements from zero to 12 kHz over large operating air gaps
- Broad operating temperature range
- Option to use innovative iBB package solution
- Additional features for TLE4954
  - Direction detection
  - Four different interface protocol options for optimized system design
- AEC-Q100 qualified

### Applications

- Automatic transmission systems
- Industrial speed sensing using current sensor interfaces

# TLE4957C(B)

## Three-Wire Transmission Speed Sensor

Differential Hall sensor TLE4957 is the ideal choice for designers who prefer to use a three-wire voltage interface rather than a two-wire current interface in applications such as transmission speed sensing. TLE4957 outperforms other devices thanks to its higher Digital Noise Constant (DNC) at start-up and its switching algorithm's increased hysteresis level. It is also available with adaptive hidden or adaptive visible hysteresis. The dynamic self-calibration principle together with the option of south or north pole pre-induction, sophisticated protection technology and optional iBB-package make TLE4957 ideal for automotive and industrial speed sensing applications.

### Features

- Greater robustness against vibration
- Highly accurate speed measurements from 1 Hz to 8 kHz over large operating air gaps
- Common three-wire voltage interface
- Broad operating temperature range
- Option of using innovative iBB-package solution
- AEC-Q100 qualified

### Applications

- Automatic transmission systems
- Engine speed (crankshaft)
- Industrial speed sensing

# TLE4983/84C

## Outstanding Camshaft Sensing

Our TLE4983/84 chopped mono-Hall sensor family comprises an excellent dedicated feature set. It is highly robust and comes with a module-style package with integrated capacitors. All of which makes it the perfect fit for automotive camshaft applications. The product family meets all key camshaft sensor requirements including true power-on, Twist-Independent Mounting (TIM) and high phase accuracy for optimum fuel-injection timing. Both sensors deploy a dynamic self-calibration algorithm with programmable power-on and a dynamic switching point. TLE4984, for example, uses an algorithm that enables fast threshold adjustments with small step sizes during the pre-calibration phase. This, in turn, allows thresholds to be adjusted very accurately. In contrast, the step sizes used by TLE4983 in the pre-calibration phase are approximately 10 times larger. TLE4983 therefore requires only half of the switching events used by TLE4984 to reach calibration mode. These flexible options give designers the freedom to choose the best start-up concept for individual system requirements.

### Features

- True power-on and high phase accuracy for optimal fuel injection timing
- Self-calibration algorithm for fast start-up and precise calibration
- Twist-Independent Mounting (TIM)
- High temperature operating range and EMC robustness
- Three-wire digital voltage interface (PWM)
- AEC-Q100 qualified

### Applications

- Camshaft speed and position sensing

# TLE4986C(B)

## Leading Performance

TLE4986C is the latest chopped mono-Hall sensor for automotive camshaft applications. It meets the most stringent requirements for phase accuracy, true power-on, EMC and temperature robustness. TLE4986C can be programmed to achieve the highest system performance with the widest range of target wheels, thus enabling designers to optimize the costs of a mechanical system while obtaining the highest phase accuracy and greatest robustness against effects such as run-out. The temperature coefficient of the magnet can also be configured to ensure that the sensor is adapted to the magnetic back-bias design. As with the TLE4983/84 family, TLE4986C also comes with proven features such as a dynamic self-calibration algorithm and module-style package plus integrated capacitors for optimal micro-break and EMC behavior.

### Features

- True power-on and highest phase accuracy for optimum fuel injection timing
- Extensive programming options for flexible design of magnetic circuits and optimized performance
- Self-calibration algorithm for fast start-up and precise calibration
- Highest temperature operating range and EMC robustness
- Best-in-class micro-break performance
- Twist-Independent Mounting (TIM) capability
- Three-wire digital voltage interface (PWM)
- AEC-Q100 qualified
- Option to use innovative iBB package solution with TLE4984

### Applications

- Camshaft speed and position sensing

# TLE5027C

## iGMR-Based Speed Sensor

TLE5027C is the world's first speed sensor solution based on Giant Magneto Resistive (iGMR) technology. It provides a higher air gap and greatly reduced jitter over frequency and temperature performance. All of which puts it ahead of other magnetic sensing technologies and makes it the preferred solution for high-accuracy powertrain speed sensor systems – both today and in the future. TLE5027C can detect the rotation direction of a wheel and transmit this information during the first output pulse, making it the perfect fit for the latest engine systems that use a start-stop feature as well as for automatic transmission applications in the automotive sector. TLE5027C is available in our well-established, module-style package with integrated capacitors. It uses a three-wire digital voltage interface (PWM).

### Features

- Outstanding jitter performance thanks to giant magneto resistive technology
- High sensitivity ( $B_{\min} < 1 \text{ mT}$ ) and large air gap capability
- Detection and transmission of rotation direction during the first output pulse
- Three-wire digital voltage interface (PWM)
- Large frequency range
- Broad operating temperature range
- AEC-Q100 qualified

### Applications

- Automatic transmission systems
- Engine speed (crankshaft)



# TLI4970

## High-Precision Current Sensor



TLI4970 is a high-precision current sensor based on our proven Hall technology. The coreless concept significantly reduces footprint compared with existing solutions.

TLI4970 is an easy-to-use, fully digital solution that does not require external calibration or additional parts such as A/D converters, 0 pAmps or reference voltage. It thus significantly reduces overall implementation effort as well as PCB space and cost.

The differential measurement principle integrated in the TLI4970 sensor suppresses interference caused by external magnetic fields. Accordingly, the sensor achieves an extremely low offset of just 25 mA. With conventional current measurement principles, the measuring accuracy is always governed by the ambient conditions (e.g. the temperature).

TLI4970 is more accurate than existing open-loop and comparable to closed-loop systems. It also provides additional functions such as fast overcurrent detection and programmable filters yet has a significantly smaller footprint and lower power consumption.

### Features

- Fully calibrated digital output
- High accuracy over life time due to on-chip temperature and stress compensation
- Programmable low-pass filter for measuring current (0–18 kHz)
- Fast, configurable overcurrent detector (< 1.8 ps typ.)
- Inherent magnetic stray field suppression
- Small package size and weight for SMD mounting

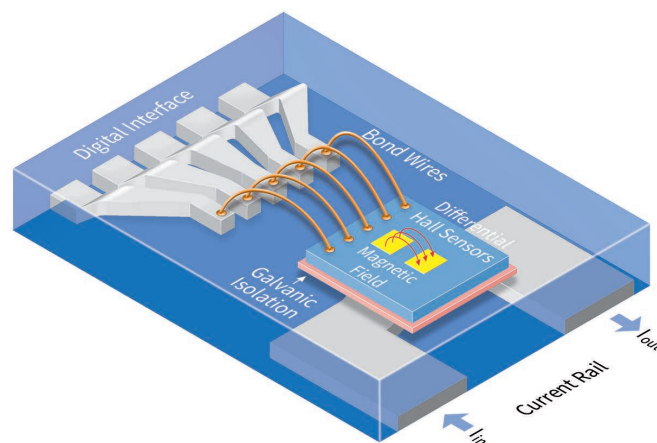

TLI4970 is extremely robust against external magnetic fields thanks to implemented stray field suppression and is also suitable for fast overcurrent detection at a pre-configurable level. This allows the control unit to switch off independently of the main measurement path and protect power consumers from damage.

### Applications (AC and DC current measurement)

- Photovoltaic and general purpose inverters
- Power supplies (SMPS)
- Battery chargers
- Lighting applications
- Electrical drives
- and many more

Product	Accuracy	Current Range	Bandwidth [kHz]	Resolution [mA]	Automotive	Industrial	Package
TLI4970-D050T4	±1.6	±50	18	12.5	–	●	PG-TISON-8
TLI4970-D050T5	±3.5	±50	18	12.5	–	●	PG-TISON-8
TLI4970-D025T4	±1.6	±25	18	6.25	–	●	PG-TISON-8
TLI4970-D025T5	±3.5	±25	18	6.25	–	●	PG-TISON-8
TLE4970-D050T4	±1.6	±50	18	12.5	On request	–	PG-TISON-8
TLE4970-D025T4	±1.6	±25	18	6.25	On request	–	PG-TISON-8



# Integrated Pressure Sensor ICs

## For Industrial and Automotive Applications



Our integrated pressure sensor family uses unique multiple surface micro-machined capacitive sensor cell arrays that support powerful self-diagnosis features such as mechanical and electrical verification of sensor functionality. Monolithic integration onto a single chip enables state-of-the-art production using a standard automotive-qualified BiCMOS process. Sophisticated sensor cell design combined with fully digital signal conditioning and processing based on high-volume production flows ensures superior quality over the entire lifecycle.

These pressure sensors are ideal for a wide range of applications in the automotive and industrial sectors.

The analog and digital interfaces of our pressure sensors provide customers with a high degree of design flexibility and enable manufacturers to meet evolving market demands.

Our digital interface portfolio ranges from PSI5 for safety products (for example side crash detection and pedestrian protection systems) through SPI for automotive powertrain and body applications (for example Barometric Air Pressure (BAP), fuel vapor and seat comfort systems) to SENT with SPC functionality for upcoming engine management products (for example MAP, Turbo MAP (with NTC) and secondary air valves).



Current automotive restraint systems use Infineon's side airbag pressure sensors to fulfill the steadily increasing safety requirements for passenger cars. In this safety-critical application, the pressure sensor is assembled within the car's side doors and provides – within fractions of a second – a digital crash signal to the central airbag unit. Self-diagnosis routines reliable proper operation every time.



As the safety standards for passenger vehicles increases beyond the side airbag for inmates to secure the safety of pedestrians, Infineon's new sensors (KP200 and KP201 for higher operating temperature) allow our customers to get the highest 5 stars evaluation for vehicle safety.

### Automotive Applications

- BAP
- Seat comfort systems
- Fuel vapor
- Idle stop
- Side crash detection
- Pedestrian impact detection

### Industrial Applications

- Industrial and process controls
- Gas flow
- Level meter
- Barometric pressure
- Altitude compensation systems
- Weather stations
- Engine management systems
- Medical equipment



# KP200/KP201

## PSI5 PRO-SIL™ Pressure Sensor ICs for Side Crash Detection and Pedestrian Protection

### Features

- Fully PSI5 compliant with support for multiple modes
- Fully AK-LV29 compliant
- Patented online diagnosis for pressure cells and circuitry
- PRO-SIL™ support in line with IEC 61508 and ISO 26262
- Synchronous or asynchronous data transmission
- Two-wire interface with on-chip current modulator for Manchester communication
- EEPROM for ID number, calibration and mode selection
- Serial service interface
- On-chip voltage regulator
- Reverse polarity protection
- Green SMD package
- KP201 qualified for higher operating temperatures up to 125 °C

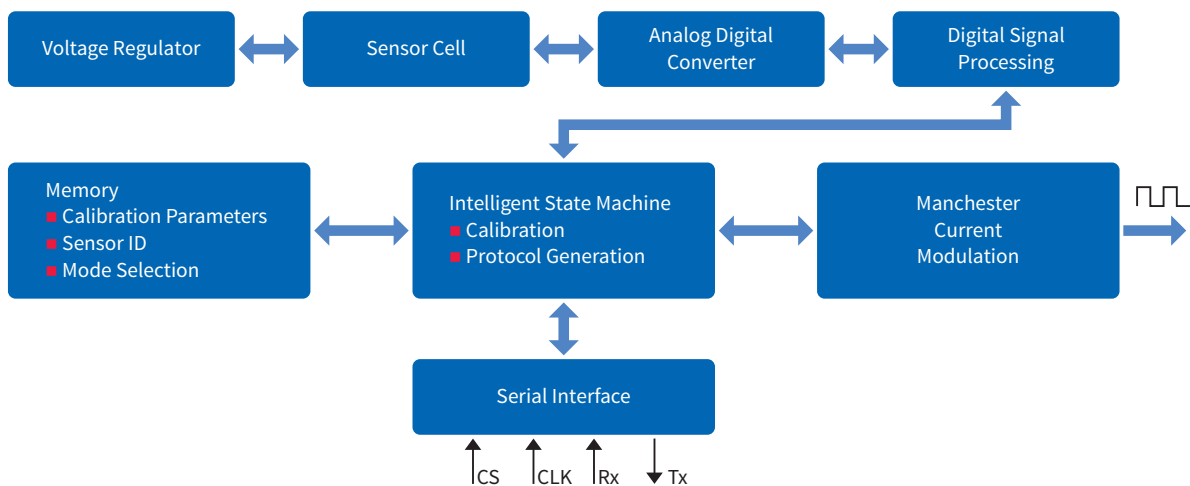

# KP108/KP109

## Multi-Protocol Pressure Sensor ICs for Side Crash Detection

### Features

- Multiple protocols (including PAS3 and PAS4)
- Synchronous or asynchronous data transmission
- User-specific protocols available
- Two-wire interface with on-chip current modulator for Manchester communication
- EEPROM for ID number, calibration and mode selection
- Patented online diagnosis for pressure cells and circuitry
- Serial service interface
- On-chip voltage regulator
- Reverse polarity protection
- Green SMD package

1) More information on PRO-SIL™, see page 49

# KP23x

## Analog Barometric Air Pressure (BAP) Sensor IC Family



Society expects cars to always deliver the same performance under all circumstances – whether by the coast or up a mountain. As the location and altitude change, quality of air and its content might also change.

In order to sense this change and enable the engine to react accordingly, Infineon offers various pressure sensors for barometric measurement with different interfaces – both analog and digital – and varying pressure ranges.

### Features

- Absolute air pressure measurement
- Excellent accuracy of 1.0 kPa over a large temperature range
- Ratiometric analog voltage output proportional to the applied pressure
- Output signal fully compensated across pressure and temperature range
- Pressure range from 40 to 115 kPa
- Temperature range from -40 to +125 °C
- Serial service interface
- Open Bond Detection for supply and GND (OBD)
- Self-diagnosis routines
- Inverse polarity protection
- Green SMD package

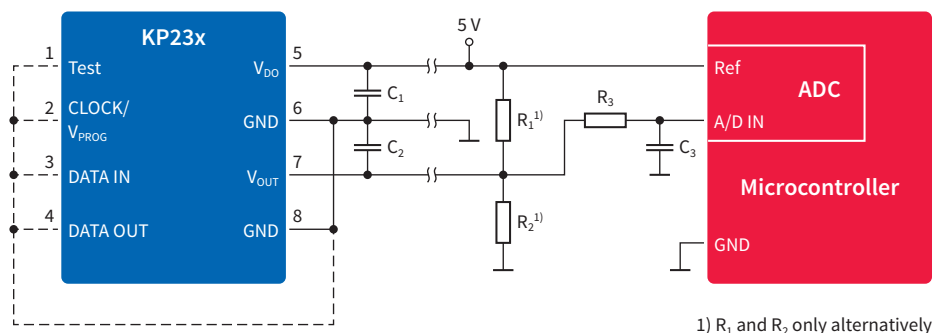

# KP21x/KP22x

## Analog Manifold Air Pressure Sensor IC Family (MAP + Turbo MAP)



Powertrain systems have to comply with increasingly stringent media requirements. Environmental legislation aims to deliver cleaner air by ensuring a steady global decrease in CO<sub>2</sub> emissions. Thanks to their accurate measurement capability, Infineon MAP and turbo MAP products with an analog interface enable engines to meet these requirements.

### Features

- Manifold air pressure measurement – MAP and turbo MAP
- Excellent accuracy of up to 1.0 kPa over a large temperature range
- Ratiometric analog voltage output proportional to the applied pressure
- Output signal fully compensated over pressure and temperature
- Pressure range from 10 to 400 kPa
- Temperature range from -40 to +140 °C
- Output clamping (optional)
- Complete product family available with multiple transfer function
- Reverse polarity protection
- Green SMD package

# KP25x

## SPI Digital Barometric Air Pressure Sensor IC Family

### Features

- SPI – digital interface
- Absolute air pressure measurement
- Excellent accuracy of 1.0 kPa over a large temperature range
- Output signal fully compensated across pressure and temperature range
- Pressure range from 40 to 165 kPa
- Temperature range from -40 to +125 °C
- Self-diagnosis routines & diagnosis codes
- Reverse polarity protection
- Diagnosis checks during operation
- Green SMD package

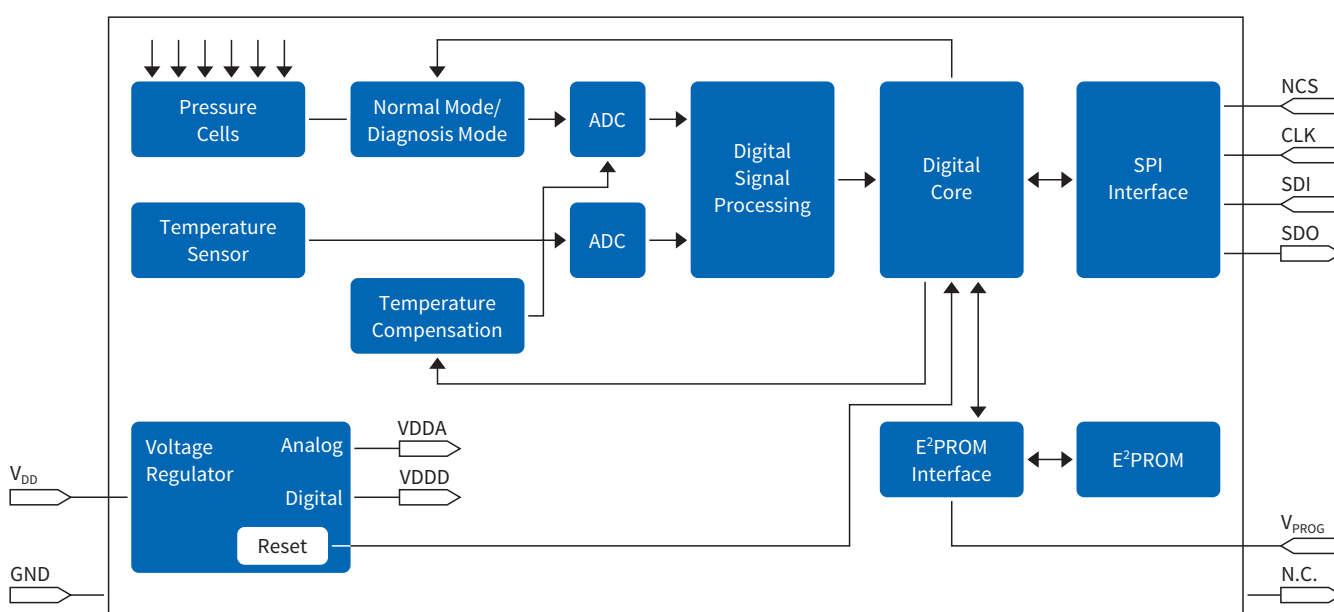

### Overview of Integrated Pressure Sensor ICs for Manifold and Barometric Air Pressure

Product	Pressure Range [kPa]	Max. Accuracy [kPa]	Max. Operating Temperature [°C]	Automotive	Industrial
KP23x	40 ... 115	1.0	125	●	●
KP236N6165	60 ... 165	1.0	125	●	●
KP21x	10 ... 115	1.0	140	●	●
KP22x	10 ... 400	2.5	140	●	●
KP253	60 ... 165	1.0	125	●	●
KP254	40 ... 115	1.5	125	●	●
KP256	60 ... 165	1.0	125	●	●

# SP27

## Pressure Sensor for Industrial and Automotive Applications

The SP27 is a pressure sensor designed for the harshest automotive and industrial environments. Among its unique selling points, the device offers a wide pressure range up to 1300 kPa and a proven sensor technology which is robust against various media.

It can be used in both wired and battery-supplied applications.

The SP27 is a complete system on package since it integrates a microcontroller with 6 kB flash and several peripherals (such as temperature and voltage sensors on top of the pressure sensor); it requires very few external components.

Its data interface is I<sup>2</sup>C; but nevertheless, the integrated  $\mu$ C allows the implementation of specific communication protocols such as SPI, SPC, SENT or PWM. The integrated microcontroller is instruction-set compatible with a standard 8051 processor. Integrated on-chip flash memory can be used to store a customer-specific application code, along with its unique ID number and the calibration data for the sensors. Additional on-chip ROM memory is available and includes functions (developed by Infineon) that cover standard tasks used by the application.

The device can be programmed to wake-up at regular intervals via its low-power interval-timer or per an external wake-up source connected to a General Purpose Input/Output (GPIO), thus allowing the application to save energy by spending most of the time in SLEEP mode.

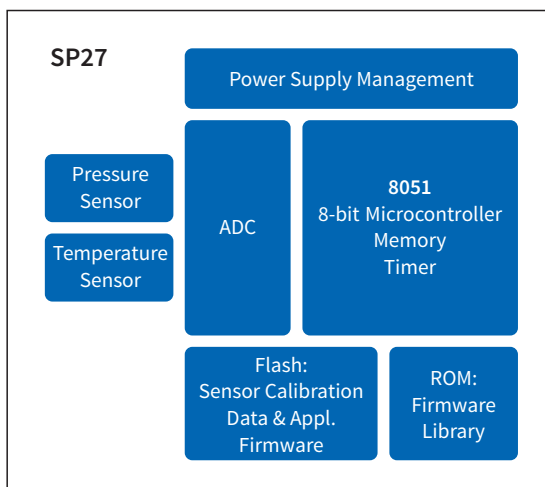

### Features

- Pressure sensor (100 to 1300 kPa)
- Temperature sensor
- Embedded 8051 compatible 8-bit microcontroller
- 6 KB on-chip flash memory
- 256 Byte RAM
- Advanced power control/wake-up system to minimize power consumption
- Ultra-low standby current of < 0.7  $\mu$ A
- Supply voltage range of 1.9 to 3.6 V
- Operating temperature range of -40 to 125 °C
- PG-DSOSP-14-6 package
- RoHS compliant, green package

Parameter	Values		Unit	Note/Test Condition
	Min.	Max.		
Input Pressure Range	100	500	kPa	T = -40 ... 125 °C
Measurement Error 100 ... 500 kPa	-21	+21	kPa	T = 25 ... 80 °C
	-46	+46	kPa	T = -40 ... 125 °C
Input Pressure Range	500	1300	kPa	T = -40 ... 125 °C
Measurement Error 500 ... 1300 kPa	-31	+31	kPa	T = 25 ... 80 °C
	-60	+60	kPa	T = -40 ... 125 °C
Temperature Measurement Error	-3	+3	°C	T = -20 ... 70 °C
	-5	+5	°C	T = -40 ... -20 °C T = 70 ... 125 °C

# SP37

## Tire Pressure Sensor for Tire Pressure Monitoring Systems (TPMS)



SP37 is a highly integrated device that performs all functions required for a Tire Pressure Monitoring System (TPMS) wheel module. It is ideal for high-volume applications, bundling the sensing elements, microcontroller, LF receiver, RF transmitter and other components in a single package. Only very few external components are required to create a TPMS module.

SP37 measures pressure, radial acceleration, temperature and supply voltage and is certified as a green package compliant with RoHS. SP37 comes in a number of variants with different pressure ranges (100 to 450 kPa, 100 to 900 kPa and 100 to 1300 kPa), making it the ideal choice for light vehicle and heavy truck applications.

### Features

- Pressure sensor
- Radial acceleration sensor
- Temperature sensor
- Supply voltage sensor
- Embedded 8051 compatible 8-bit microcontroller
- 6 KB on-chip flash memory
- 256 Byte RAM
- 315 and 434 MHz FSK/ASK
- RF transmitter
- Output power of 5 or 8 dBm
- 125 kHz ASK high-sensitivity LF receiver
- Advanced power control/wake-up system to minimize battery consumption
- Ultra-low standby current of  $< 0.7 \mu\text{A}$
- Supply voltage range from 1.9 to 3.6 V
- Operating temperature range from  $-40$  to  $+125 \text{ }^\circ\text{C}$
- PG-DSOSP-14-6 package
- RoHS compliant, green package

Product Name	Pressure Range [kPa]	Key Benefits
SP370-25-106-0	100–450	<ul style="list-style-type: none"> <li>■ Highest integration</li> <li>■ Very low energy consumption</li> <li>■ Robust g- and p- sensor</li> <li>■ High LF sensitivity</li> </ul>
SP370-25-116-0	100–900	
SP370-23-156-0	100–1300	

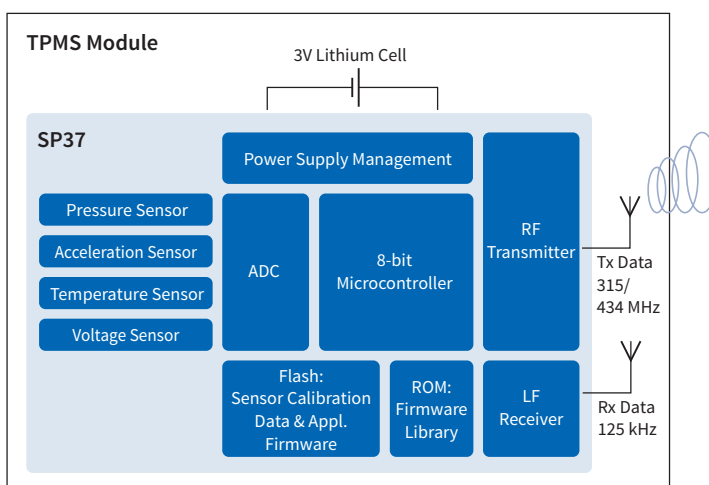

SP37 fully supports all necessary requirements for a Tire Pressure Monitoring System (TPMS)



# RASIC™

## Front-End ICs for Automotive RADARs



Since volume production started in 2009, RASIC™ chips have become the market leader in the 77 GHz SiGe MMIC segment. They can be used in different configurations to build RF front-end modules for sensors in applications such as Long-Range RADARs (LRR) (for example ACC), Lane Change Assist (LCA) and Blind Spot Detection (BSD) systems as well as in Collision Mitigation (CM) and Emergency Brake Assist (EBA) features. All components are AEC-Q100 qualified and specified over the full -40 ... +125 °C automotive temperature range.

### **RTN7735PL Transmitter and RRN7745PL Receiver in eWLB**

RTN7735PL and RRN7745P are the first 77 GHz solutions based on an eWLB package instead of a bare-die. They form a scalable platform comprising a three-channel transmitter and a four-channel receiver to build long- and mid-range systems.

### **RPN7720PL Power Amplifier in eWLB**

The RPN7720PL dual-power amplifier allows to increase system output power plus additional output switching and phase shifting of two Tx channels.

### **RCC1010 RADAR Companion Chip in PG-TQFP-48 PGN**

The RCC1010 radar companion is a CMOS chip which provides a fully digital interface to RTN7730 and RTN7735P. It features freely programmable modulation waveform generation and PLL frequency control.

# Functional Safety – ISO 26262



ISO 26262 defines the development of electric and electronic automotive systems with regard to their functional safety.

The aim of this standard is to reduce possible hazards caused by the failure and malfunction of such systems. The safety requirements for the development process depend on the ASIL rating of the target application and can range from ASIL-A to ASIL-D.

Applications such as steering or braking systems are rated with the highest ASIL-D level.

A failure in such a system can lead to an out-of-control vehicle, possibly resulting in fatal injuries.

All newly developed parts will be based on an ISO 26262-compliant development flow, thereby allowing direct use in all safety-relevant applications.

Devices which are developed prior to the ISO 26262 as a QM part can nevertheless be used in ISO-compliant systems as outlined in Part 8 Clause 13 of the standard.

In such cases, it is mandatory “to provide evidence of the suitability of ... hardware components and parts” for use in ISO-compliant systems and also to provide failure modes, their distribution and diagnostic capability.

To support our customers as they strive to achieve the highest ASIL on system level, Infineon provides both the necessary support for qualification of existing pre-

ISO 26262 products, and fully ISO 26262-compliant products of the future.

For a set of existing Infineon sensor ICs, extensive functional safety analyses have been conducted for various application use cases by means of FMEDA (Failure Mode, Effects and Diagnostic Analysis), DFA (Dependent Failure Analysis) and also FTA (Fault-Tree Analysis) to make them “ASIL-ready”. The resulting FIT rates and safety-related judgements of these analyses are summarized in Safety Analysis Summary Reports. These reports are available to customers for interfacing with their system-level safety concept. The preferred implementation of the “ASIL-ready” sensor ICs is described in dedicated safety manuals. Additionally, Infineon offers expert support for system integrators in achieving the required ASIL on system level.

Future Infineon sensor IC developments for safety-related applications will follow the full ISO 26262-compliant process: A V-model based requirements capturing and verification process ensures the fulfillment of ASIL-rated safety requirements. Furthermore, dedicated safety analyses are already performed during development to support the achievement of the required safety targets. The resulting sensor IC can therefore be easily used in safety-related applications.

## Infineon’s PRO-SIL™ Program, Designed to Protect



The functional complexity and levels of integration of real-time safety-critical applications continue to increase.

Norms such as IEC 61509 and ISO 26262 mandate more robust and comprehensive product development processes and functional safety concepts in automotive and industrial applications.

More information on PRO-SIL™ can be found at [www.infineon.com/prosil](http://www.infineon.com/prosil)

Infineon’s PRO-SIL™ safety program is designed to ease and speed up your automotive and industrial design to comply with such standards. Across the full certification spectrum from Safety Integrity Levels (SIL) 1 to 4 and Automotive Safety Integrity Levels (ASIL) A to D, our end-to-end PRO-SIL™ approach will help you select the right hardware, software and functional safety concepts to meet your design and compliance needs.



# Sensing the World

## Simulation Tools for Purchasing the Most Suitable Infineon Sensor Combined with the Best-Fit Magnet

- The Simulation Tool for **Hall Switches** provides two different movement options – transverse or perpendicular



- The Magnetic Design Tool for **Angle Sensors** is simple to use



**Sensor Desk**  
Magnetic Design Tools

Hall Switches | Angle Sensors

transverse movement

perpendicular movement

Reset Simulate >

**Sensor Desk**  
Magnetic Design Tools

Hall Switches | Angle Sensors

Reset Calculate >

- They can be easily reached through our website @ sensor ICs, on the right-side of the page

# Packages

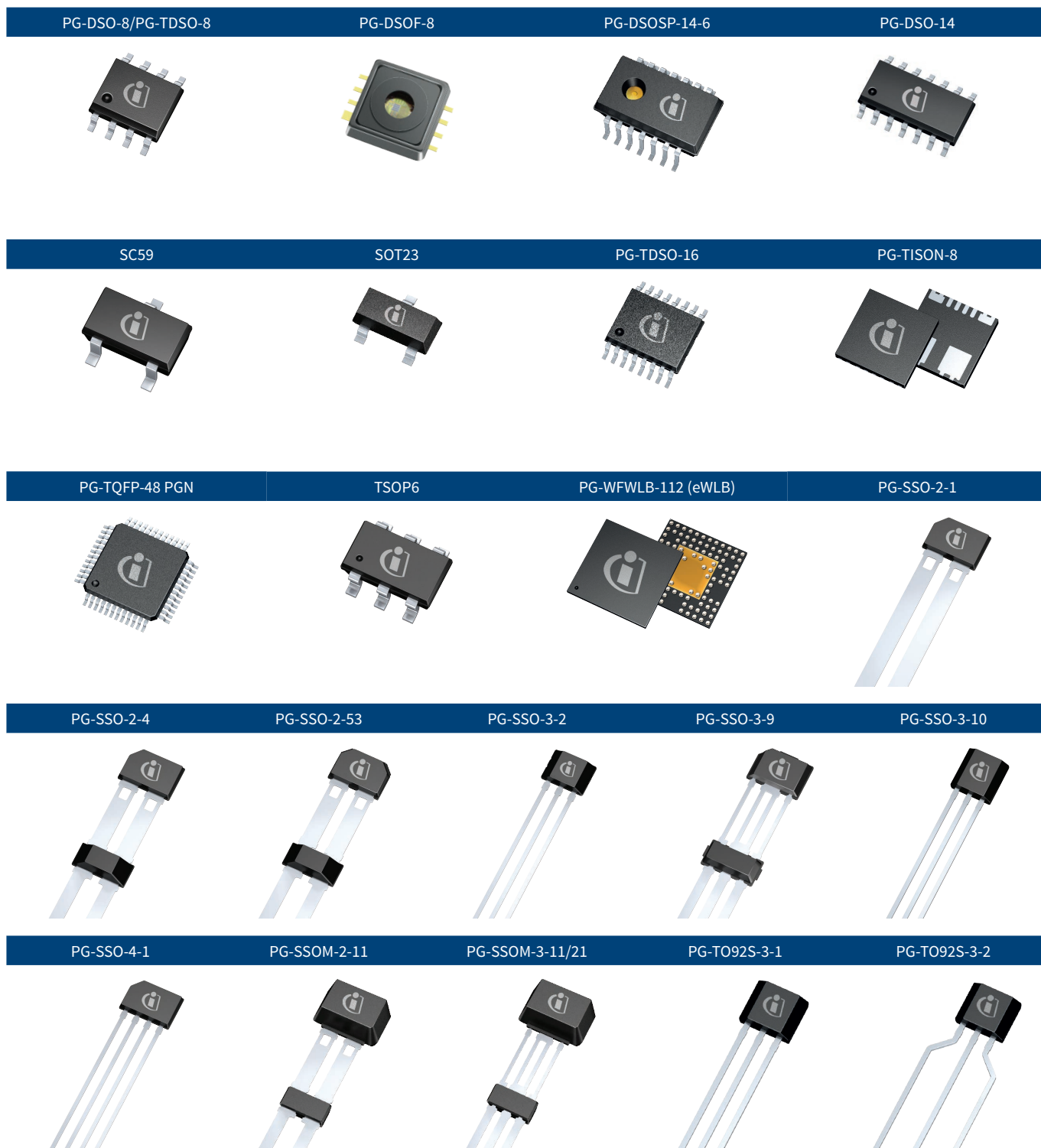

For further information on Infineon packages, please visit our website at [www.infineon.com/packages](http://www.infineon.com/packages)

# Ask Infineon. Get Connected with the Answers.

Infineon offers its toll-free 0800/4001 service hotline as one central number, available 24/7 in English, Mandarin and German.

Our global connection service goes way beyond standard switchboard services by offering qualified support on the phone. Call us!

- Germany ..... 0800 951 951 951 (German/English)
- China, mainland ..... 4001 200 951 (Mandarin/English)
- India ..... 000 800 4402 951 (English)
- USA ..... 1-866 951 9519 (English/German)
- Other countries ..... 00\* 800 951 951 951 (English/German)
- Direct access ..... +49 89 234-0 (interconnection fee, German/English)

\* Please note: Some countries may require you to dial a code other than "00" to access this international number, please visit [www.infineon.com/service](http://www.infineon.com/service) for your country!

## Where to Buy

Infineon Distribution Partners and Sales Offices:

[www.infineon.com/WhereToBuy](http://www.infineon.com/WhereToBuy)

## Stay Connected

 [www.facebook.com/infineon](http://www.facebook.com/infineon)

 [www.google.com/+infineon](http://www.google.com/+infineon)

 [www.twitter.com/infineon](http://www.twitter.com/infineon)

 [www.infineon.com/linkedin](http://www.infineon.com/linkedin)

 [www.infineon.com/xing](http://www.infineon.com/xing)

 [www.youtube.com/infineon](http://www.youtube.com/infineon)

## Mobile Product Catalog

Mobile app for iOS and Android:  
[www.infineon.com/apps](http://www.infineon.com/apps)

Published by  
Infineon Technologies AG  
85579 Neubiberg, Germany

© 2015 Infineon Technologies AG.  
All Rights Reserved.

Visit us:  
[www.infineon.com](http://www.infineon.com)

### Please note!

THIS DOCUMENT IS FOR INFORMATION PURPOSES ONLY AND ANY INFORMATION GIVEN HEREIN SHALL IN NO EVENT BE REGARDED AS A WARRANTY, GUARANTEE OR DESCRIPTION OF ANY FUNCTIONALITY, CONDITIONS AND/OR QUALITY OF OUR PRODUCTS OR ANY SUITABILITY FOR A PARTICULAR PURPOSE. WITH REGARD TO THE TECHNICAL SPECIFICATIONS OF OUR PRODUCTS, WE KINDLY ASK YOU TO REFER TO THE RELEVANT PRODUCT DATA SHEETS PROVIDED BY US. OUR CUSTOMERS AND THEIR TECHNICAL DEPARTMENTS ARE REQUIRED TO EVALUATE THE SUITABILITY OF OUR PRODUCTS FOR THE INTENDED APPLICATION.

WE RESERVE THE RIGHT TO CHANGE THIS DOCUMENT AND/OR THE INFORMATION GIVEN HEREIN AT ANY TIME.

### Additional information

For further information on technologies, our products, the application of our products, delivery terms and conditions and/or prices please contact your nearest Infineon Technologies office ([www.infineon.com](http://www.infineon.com)).

### Warnings

Due to technical requirements, our products may contain dangerous substances. For information on the types in question please contact your nearest Infineon Technologies office.

Except as otherwise explicitly approved by us in a written document signed by authorized representatives of Infineon Technologies, our products may not be used in any life endangering applications, including but not limited to medical, nuclear, military, life critical or any other applications where a failure of the product or any consequences of the use thereof can result in personal injury.

Order Number: B142-I0126-V1-7600-EU-EC-P  
Date: 05 / 2015