

Precise non-contact temperature measurement of metal from 50 °C to 1800 °C

Features:

- Miniaturized Infrared Thermometer with 2.3 μm wave length range for measurements of metals, of secondary metal processing, metal oxides and ceramic materials
- Very small sensing head of 14 mm diameter and 28 mm length fits everywhere and is usable up to 85 °C ambient temperature without cooling
- Temperature measuring ranges from 50 °C to 1800 °C and exposure times starting from 1 ms
- Short wave length range of 2.3 μm to reduce error of reasuring with measurements on materials with unknown emissivity



General Specifications

Environmental rating	IP 65 (NEMA-4)
Ambient temperature	-20 °C ... 85 °C (sensing head) 0 °C ... 85 °C (electronics)
Storage temperature	-40 °C ... 125 °C (sensing head) -40 °C ... 85 °C (electronics)
Relative humidity	10–95 %, non-condensing
Vibration (sensor)	IEC 60068-2-6 (sinus shaped) IEC 60068-2-64 (broadband noise)
Shock (sensor)	IEC 60068-2-27 (25G and 50G)
Weight	40 g (sensing head) 420 g (electronics)

Electrical Specifications

Outputs / analog	0/4–20 mA, 0–5/10 V, thermocouple J, K, alarm
Outputs / alarm	24 V/ 50 mA (open collector)
Optional	Relay: 2 x 60 V DC/ 42 V AC _{eff.} 0.4 A; optically isolated
Outputs / digital	USB, RS232, RS485, CAN, Profibus DP, Ethernet (optional)
Output impedances	mA max. 500 Ω (with 8–36 V DC) mV min. 100 kΩ load impedance thermocouple 20 Ω
Inputs	Programmable functional inputs for external emissivity adjustment, ambient temperature compensation, trigger (reset of hold functions)
Cable length	3 m
Power Supply	8–36 V DC
Current draw	Max. 100 mA

Measurement Specifications

Temperature ranges (scalable via programming keys or software) ¹⁾	50 °C ... 400 °C (3ML) 100 °C ... 600 °C (3MH) 150 °C ... 1000 °C (3MH1) ⁴⁾ 200 °C ... 1500 °C (3MH2) ⁴⁾ 250 °C ... 1800 °C (3MH3) ⁴⁾
Spectral ranges	2.3 μm
Optical resolution (90 % energy)	22:1 (3ML) 33:1 (3MH) 75:1 (3MH1–3MH3)
System accuracy ²⁾ (at ambient temp. 23 ± 5 °C)	±(0.3 % of reading + 2 °C)
Repeatability (at ambient temp. 23 ± 5 °C)	±(0.1 % of reading + 1 °C)
Temperature resolution	0.1 K
Exposure time ³⁾	1 ms (90 %)
Emissivity / Gain (adjustable via programming keys or software)	0.100–1.100
Transmissivity / Gain (adjustable via programming keys or software)	0.100–1.100
Signal processing (parameter adjustable via programming keys or software, respectively)	Peak hold, valley hold, average; extended hold function with threshold and hysteresis
Software	optris® Compact Connect

¹⁾ $T_{object} > T_{sensing\ head} + 25\text{ °C}$

²⁾ $\epsilon = 1$, response time 1 s

³⁾ With dynamic adaptation at low signal levels

⁴⁾ Specification valid at $T_{object} \geq \text{start of measurement range} + 50\text{ °C}$

Optical Specifications

Optics CT 3ML SF, D:S = 22:1

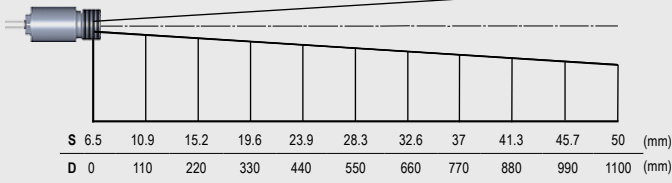

Optics CT 3ML CF, D:S = 22:1 (far field = 9:1)

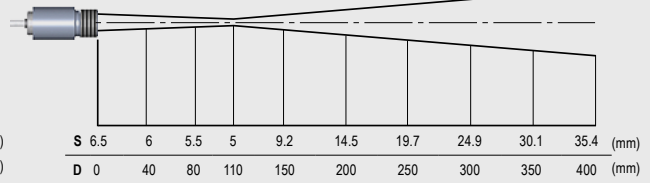

Optics CT 3MH SF, D:S = 33:1

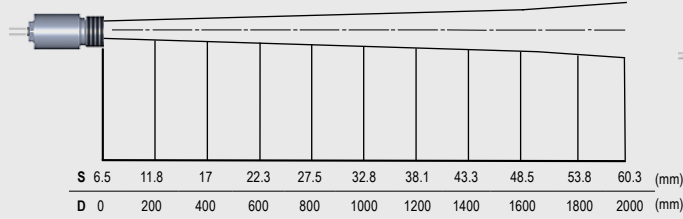

Optics CT 3MH CF, D:S = 33:1 (far field 11:1)

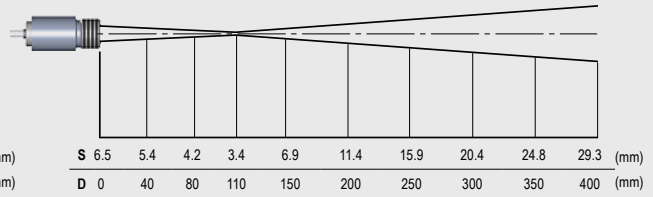

Optics CT 3MH1-H4 SF, D:S = 75:1

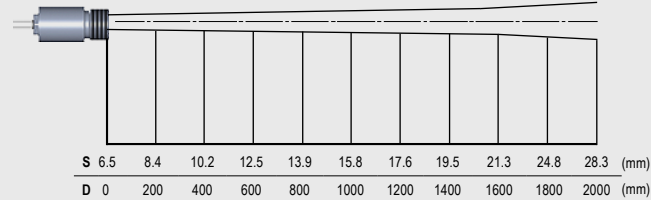

Optics CT 3MH1-H4 CF, D:S = 75:1 (far field 40:1)

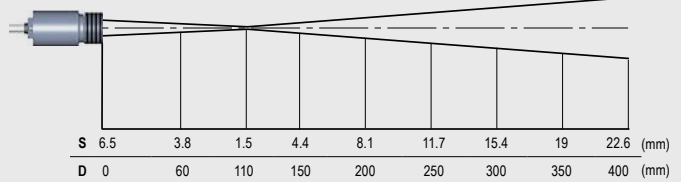

Dimensions

Sensing head (standard)

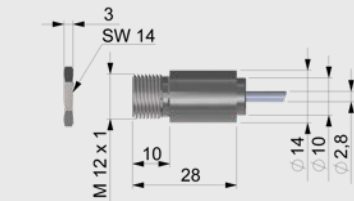

Sensing head (built-in CF lens)

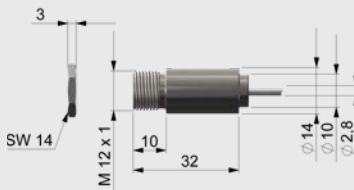

Electronics

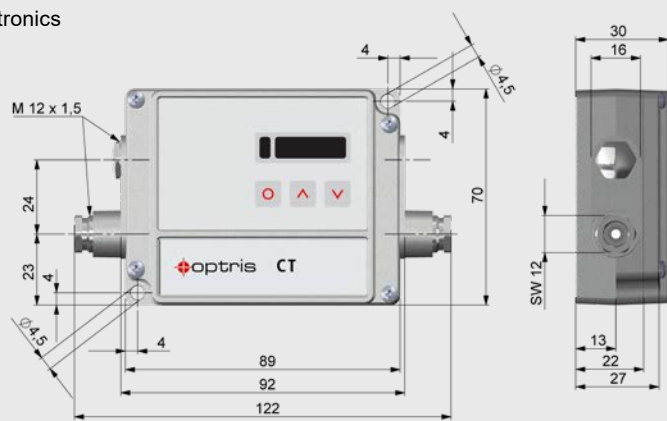

Accessories (examples)

CF-lens (ACCTCFHT)

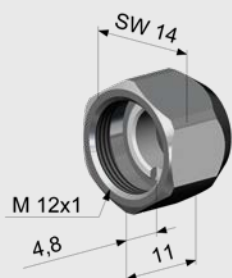

Mounting bracket, fixed (ACCTFB)

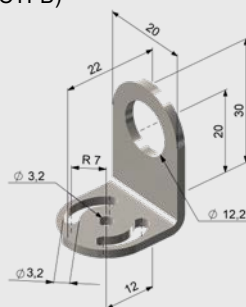

Air purge collar with integrated CF-lens (ACCTAPLCFHT)

