

E11816

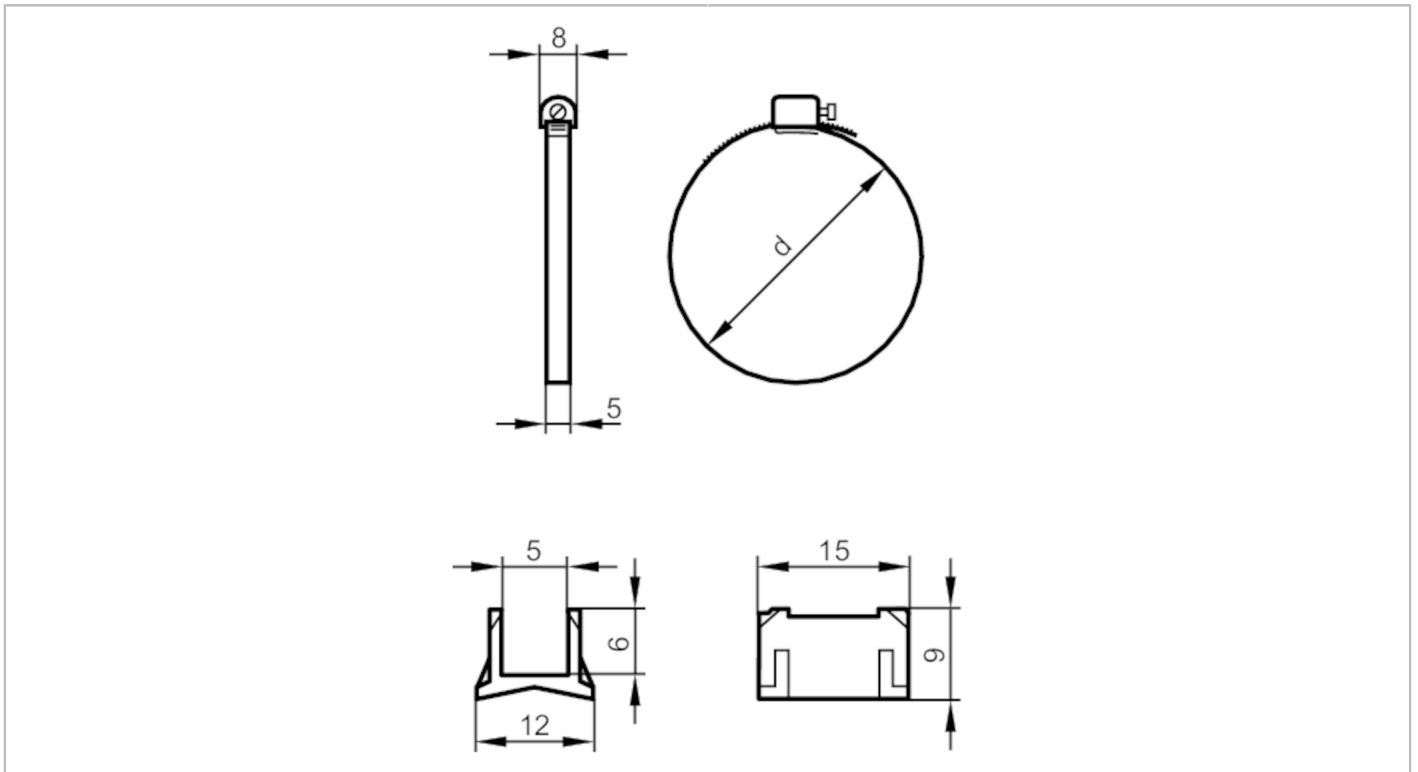

Fixing strap for clean-line cylinders

FIXING STRAP CLEAN-LINE CYL



Mechanical data

Weight	[g]	5.7
Dimensions	[mm]	Ø 8
Materials		Adapter: PA; fixing strap: stainless steel (1.4305 / 303)
Piston diameter	[mm]	8...12
Clamping range	[mm]	11...19

Accessories

Accessories (supplied)	Adapter., for types, MKT
------------------------	--------------------------

Remarks

Pack quantity	1 pcs.
---------------	--------