

3-conductor ground terminal block

Item No.: 280-687



3-conductor ground terminal block

Marking

RoHS ✓
Compliant

Business data

Supplier	WAGO
Item no.	280-687
GTIN / EAN	4045454100148
Content	1
Order amount	100
Customer item number	

Notes

Technical data

Miscellaneous

Total number of connection points	3
Total number of potentials	1
Color	green-yellow
Ratings according to 1	IEC/EN 60947-7-2
Connection technology (1)	CAGE CLAMP®
Solid sizes 1	0.08 ... 2.5 mm ² / 28 ... 12 AWG
Fine-stranded wires 1	0.08 ... 2.5 mm ² / 28 ... 12 AWG
Strip length 1	8 ... 9 mm / 0.31 ... 0.35 in
Note (conductor cross-section)	12 AWG: THHN, THWN
Type of wiring	Front-entry wiring

Technical data	
<i>Design</i>	<i>horizontal</i>
<i>Marking level</i>	<i>Center marking</i>
<i>Insulating material</i>	<i>Polyamide 66 (PA 66)</i>
<i>Fire load [MJ]</i>	<i>0.11 [MJ]</i>
<i>Weight [g]</i>	<i>11.283 [g]</i>
<i>Width</i>	<i>5 mm / 0.197 in</i>
<i>Height from upper-edge of DIN-rail [mm]</i>	<i>28 [mm]</i>
<i>Height from upper-edge of DIN-rail</i>	<i>28 mm / 1.102 in</i>
<i>Length</i>	<i>64 mm / 2.52 in</i>
<i>Type of mounting</i>	<i>DIN 35 rail</i>

Images & drawings

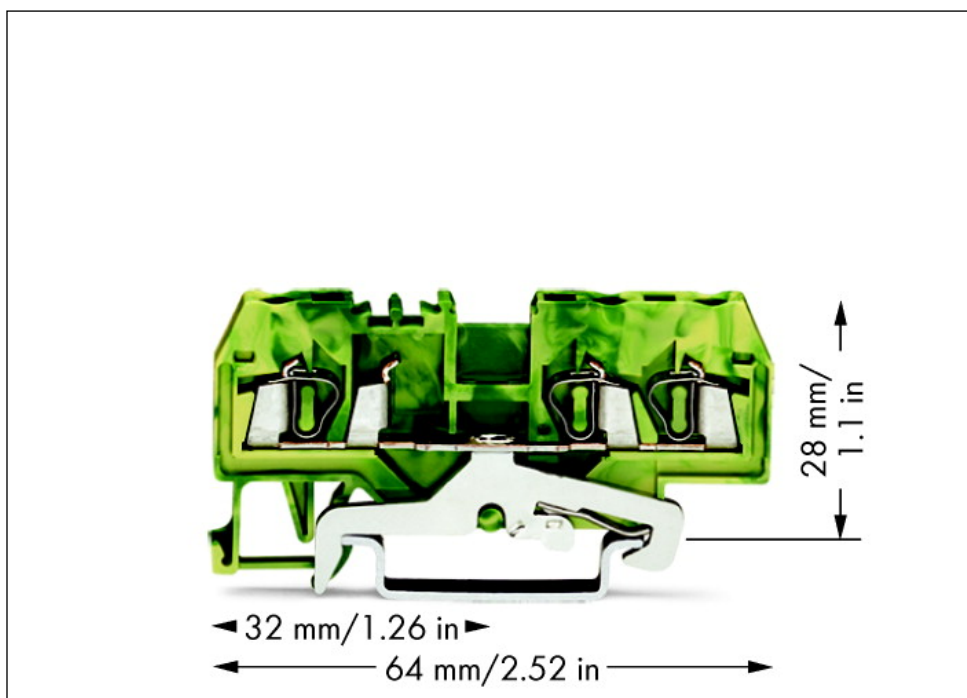

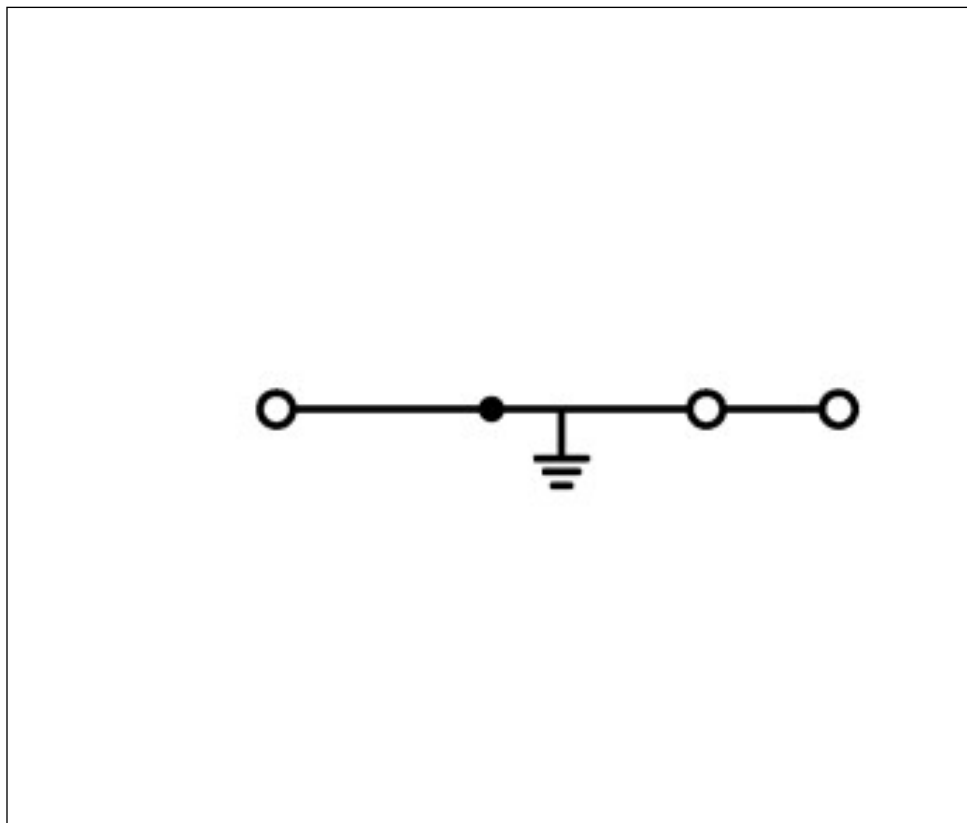

Address

WAGO Kontakttechnik GmbH & Co. KG

Hansastr. 27

32423 Minden

Telefon: 0571/887-0

Fax: 0571/887-169

<http://www.wago.com>

© WAGO Kontakttechnik GmbH & Co. KG

Technische Änderungen und Irrtümer vorbehalten.